

# HP 8642A/B SYNTHESIZED SIGNAL GENERATOR (Including Options 001, 002 and 003)

## Service Manual VOLUME 1 SERIAL NUMBERS

This manual applies directly to modules with serial numbers prefixed:

2427A to 2816A and all *MAJOR* changes that apply to your instrument/modules.

*rev.01NOV88*

For additional important information about serial numbers, refer to "INSTRUMENTS COVERED BY THIS MANUAL" in Section 1.

Second Edition

This material may be reproduced by or for the U.S. Government pursuant to the Copyright License under the clause at DFARS 52.227-7013 (APR 1988).

©HEWLETT-PACKARD COMPANY 1985  
EAST 24001 MISSION AVENUE, TAF C-34, SPOKANE, WASHINGTON, U.S.A. 99220

Service Manual HP Part 08642-90226

**Other Documents Available:**

Microfiche Operation and Calibration Manual HP Part 08642-90225

Operation and Calibration Manual HP Part 08642-90224

Microfiche Service Manual HP Part 08642-90227

Printed in U.S.A. : November 1988



*DIGITALY REMASTERED*  
*OUT OF PRINT*  
*HEWLETT PACKARD MANUAL SCANS*

By

*Artek Media*

18265 200<sup>th</sup> St.  
Welch, MN 55089

[www.artekmedia.com](http://www.artekmedia.com)

“High resolution scans of obsolete technical manuals”

**ALL HEWLETT PACKARD MANAULS ARE REPRODUCED BY PERMISSION AND UNDER LICENSE AGREEMENT WITH AGILENT TECHNOLOGIES, INC. REMOVAL OF THIS DISCLAIMER IS INVIOATION OF AGILENT TECHNOLOGIES AND ARTEK MEDIA’S COPYRIGHTS. DUPLICATION OR MODIFCATION OF THIS DIGITAL DOCUMENT WITHOUT PRIOR CONSENT IS NOT PERMITTED**

If your looking for a quality scanned technical manual in PDF format please visit our WEB site at [www.artekmedia.com](http://www.artekmedia.com) or drop us an email at [manuals@artekmedia.com](mailto:manuals@artekmedia.com) and we will be happy to email you a current list of the manuals we have available.

If you don't see the manual you need on the list drop us a line anyway we may still be able to point you to other sources. If you have an existing manual you would like scanned please write for details. This can often be done very reasonably in consideration for adding your manual to our library.

Typically the scans in our manuals are done as follows;

- 1) Typed text pages are typically scanned in black and white at 300 dpi.
- 2) Photo pages are typically scanned in gray scale mode at 600 dpi
- 3) Schematic diagram pages are typically scanned in black and white at 600 dpi unless the original manual had colored high lighting (as is the case for some 70's vintage Tektronix manuals).
- 4) Most manuals are text searchable
- 5) All manuals are fully bookmarked

All data is guaranteed for life (yours or mine ... which ever is shorter). If for ANY REASON your file becomes corrupted, deleted or lost, Artek Media will replace the file for the price of shipping, or free via FTP download.

Thanks

Dave & Lynn Henderson  
Artek Media

## SAFETY CONSIDERATIONS

### GENERAL

This product and related documentation must be reviewed for familiarization with safety markings and instructions before operation.

This product is a Safety Class I instrument (provided with a protective earth terminal).

### BEFORE APPLYING POWER

Verify that the product is set to match the available line voltage and the correct fuse is installed.

### SAFETY EARTH GROUND

An uninterruptible safety earth ground must be provided from the main power source to the product input wiring terminals, power cord, or supplied power cord set.

### SAFETY SYMBOLS



Instruction manual symbol: the product will be marked with this symbol when it is necessary for the user to refer to the instruction manual (refer to Table of Contents).



Indicates hazardous voltages.



Indicates earth (ground) terminal.

#### WARNING

The WARNING sign denotes a hazard. It calls attention to a procedure, practice, or the like, which, if not correctly performed or adhered to, could result in personal injury. Do not proceed beyond a WARNING sign until the indicated conditions are fully understood and met.

#### CAUTION

The CAUTION sign denotes a hazard. It calls attention to an operating procedure, practice, or the like, which, if not correctly performed or adhered to, could result in damage to or destruction of part or all of the product. Do not proceed beyond a CAUTION sign until the indicated conditions are fully understood and met.

#### WARNING

*Any interruption of the protective (grounding) conductor (inside or outside the instrument) or disconnecting the protective earth terminal will cause a potential shock hazard that could result in personal injury. (Grounding one conductor of a two conductor outlet is not sufficient protection).*

*Whenever it is likely that the protection has been impaired, the instrument must be made inoperative and be secured against any unintended operation.*

*If this instrument is to be energized via an autotransformer (for voltage reduction) make sure the common terminal is connected to the earth terminal of the power source.*

*Servicing instructions are for use by service-trained personnel only. To avoid dangerous electric shock, do not perform any servicing unless qualified to do so.*

*Adjustments described in the manual are performed with power supplied to the instrument while protective covers are removed. Energy available at many points may, if contacted, result in personal injury.*

*Capacitors inside the instrument may still be charged even if the instrument has been disconnected from its source of supply.*

*For continued protection against fire hazard, replace the line fuse(s) only with 250V fuse(s) of the same current rating and type (for example, normal blow, time delay, etc.). Do not use repaired fuses or short circuited fuseholders.*

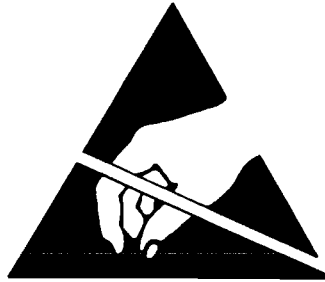

**ATTENTION  
Static Sensitive  
Devices**

*This instrument was constructed in an ESD (electro-static discharge) protected environment. This is because most of the semi-conductor devices used in this instrument are susceptible to damage by static discharge.*

*Depending on the magnitude of the charge, device substrates can be punctured or destroyed by contact or mere proximity of a static charge. The results can cause degradation of device performance, early failure, or immediate destruction.*

*These charges are generated in numerous ways such as simple contact, separation of materials, and normal motions of persons working with static sensitive devices.*

*When handling or servicing equipment containing static sensitive devices, adequate precautions must be taken to prevent device damage or destruction.*

*Only those who are thoroughly familiar with industry accepted techniques for handling static sensitive devices should attempt to service circuitry with these devices.*

*In all instances, measures must be taken to prevent static charge build-up on work surfaces and persons handling the devices.*

*For further information on ESD precautions, refer to "SPECIAL HANDLING CONSIDERATIONS FOR STATIC SENSITIVE DEVICES" in Section VIII Service Section.*

## SECTION VI

### REPLACEABLE PARTS

#### 6-1. INTRODUCTION

This section contains information for identifying and ordering replacement parts for the HP 8642.

#### 6-2. ABBREVIATIONS

Table 6-1 lists abbreviations used in the parts list, schematics and throughout this manual. In some cases, two forms of the abbreviation are used, one all in capital letters, and one partial or no capitals. This occurs because the abbreviations in the parts list are always all capitals. However, in the schematics and other parts of the manual, other abbreviation forms are used with both lower case and upper case letters.

#### 6-3. REPLACEABLE PARTS LIST

Table 6-3 is the list of replaceable parts and is organized as follows:

- a. Modules in alpha-numerical order by reference designation.
  1. Module mechanical parts and intramodular cables in alpha-numeric order by reference designator.
  2. Board assemblies and their components in alpha-numeric order by reference designator.
- b. Miscellaneous chassis-mounted parts and intermodular cables in alpha-numerical order by reference designation.

The information given for each part consists of the following:

- a. The Hewlett-Packard part number.
- b. Part number check digit (CD).
- c. The total quantity (Qty) per instrument (listed at the first occurrence of the part number in the list).
- d. The description of the part.
- e. A typical manufacturer of the part in a five-digit code.
- f. The manufacturer's number for the part.

#### 6-4. RESTORED MODULE EXCHANGE

Some of the modules within the instrument may be replaced on an exchange basis, thus affording a considerable cost savings. Restored, factory-repaired and tested (calibrated) modules are available on a trade-in basis; therefore, the defective modules must be returned for credit. This is Hewlett-Packard's Blue Stripe Program. Modules required for spare parts stock must be ordered by the new Module Kit part number. Some of the modules may not be included in the Blue Stripe Program and must be ordered by the new part number.

To order blue stripe Module Kits refer to paragraph 6-5. **ORDERING INFORMATION.** An exchange module kit will be sent. Tag the defective module with the special tag provided, and return the defective module within thirty days. When the replacement Module Kit arrives, save the special packaging material in which it was shipped and use it to package and return the defective module.

## 6-5. ORDERING INFORMATION

**Instrument Serial Numbers.** Attached to the rear of the instrument is a serial number plate. The first four digits and the letter are the **Instrument Serial Prefix (ISP)**. The last five digits (suffix) are unique to each instrument. The contents of this manual apply directly to instruments having the same serial prefix(es) as those listed on the title page. To update your manual to different serial prefixes, refer to paragraph 6-7.

**Module Configuration Codes (MCC).** In addition to the instrument serial prefix, each module in the instrument has a Module Configuration Code.

There will be two labels on each module:

One is the five digit module number: . This number is not needed for parts ordering.

The other is the nine digit module identification code: . The first four digits of the nine digit code comprise the **Module Configuration Code (MCC)**. The last five digits are the calibration data code.

**Ordering.** Parts in the parts list which are peculiar to a Module Configuration Code (MCC) or Instrument Serial Prefix (ISP) will be called out in the parts list. Reference the parts listed under the configuration code or serial prefix of your module.

Instrument level parts must be ordered by the serial prefix of the instrument. Module level parts must be ordered by the module configuration code. For example:

To order a part outside a module (parts found in the parts list under "MISCELLANEOUS PARTS"), use the **Instrument Serial Prefix (ISP)**. In the example below the ISP 2448A.

To order a part inside a module (parts found in the parts list prefixed with an assembly number, such as A19MP1), use the **Module Configuration Code (MCC)**. In the example below the MCC is 2452A.

Instrument Serial Number is

Module Identification Number is

If no configuration code or serial prefix is listed for a part number, you may assume that it is compatible for all configurations.

To order a part in the Replaceable Parts List, Call or write the nearest Hewlett-Packard Sales Office. Have the following information compiled to speed the ordering process:

1. The Hewlett-Packard part number with the check digit. (The check digit will ensure accurate and timely processing of your order.)
2. The quantity required.
3. An approved purchase order number may also be required.

#### NOTE

*Within the USA, it is better to order directly from the HP Parts Center in Mountain View, California. Ask your nearest HP office for information and forms for the "Direct Mail Order System."*

#### 6-6. RECOMMENDED SPARES LIST

Stocking spare parts for an instrument is often done to ensure quick return to service after a malfunction occurs. Hewlett-Packard prepares a "Recommended Spares" list for this instrument. The contents of the list are based on failure reports and repair data. Quantities given are for one year of parts support. A complimentary copy of the "Recommended Spares" list and information concerning a "Spare Parts Kit" may be requested from your nearest Hewlett-Packard office.

When stocking parts to support more than one instrument or to support a variety of Hewlett-Packard instruments, it may be more economical to work from one consolidated list rather than simply adding together stocking quantities from the individual instrument lists. Hewlett-Packard will prepare consolidated "Recommended Spares" lists for any number or combination of instruments. Contact your nearest Hewlett-Packard office for details.

#### 6-7. PARTS LIST UPDATING

A "MANUAL UPDATES" packet is shipped with the manual, when necessary, to provide the most current information available at the time of shipment. These packets consist of replacement and addition pages which should be incorporated into the manual to bring it up to date.

Hewlett-Packard offers a **Documentation Update Service** that will provide you with further updates as they become available. If you operate or service instruments of different serial prefixes, we strongly recommend that you join this service immediately to ensure that your manual is kept current. For more information, refer to the **Documentation Update Service** reply card included in this manual, or write:

Hewlett-Packard Company  
Technical Writing Department  
24001 E. Mission -- TAF C-34  
Spokane, WA 99220

or call:

Technical Writing Department  
(509) 922-4001

## 6-8. ILLUSTRATED PARTS BREAKDOWN AND INTERNAL PHOTOS

Most mechanical parts, chassis parts, and cables are identified in Figures 6-1 through 6-5. These Figures are located at the end of this section. **Figure 6-1** shows reference designators for cabinet parts. **Figure 6-2** shows reference designators for front and rear panel connectors and mechanical parts. **Figure 6-3** is a top internal view showing reference designators for internal mechanical parts. **Figure 6-4** is a top internal view of the instrument showing reference designators for cables. **Figure 6-5** is a bottom view of the instrument.

Major mechanical parts have reference designations that begin with the letters **MP**. To find the part number and description of a mechanical part, find the part in one of the figures in this Section VI. Part numbers for the parts called out in these figures can be found in one of two places. Part numbers can be found near the end of the parts list under **MISCELLANEOUS PARTS**, or the parts prefixed with an assembly number, for example A19MP3, are listed under the Module reference designator (in this case A19).

Other mechanical parts, such as screws, are listed under the part which they attach. For example, the screws that attach MP64 (fan access cover) to MP6 (rear panel) are listed under MP64.

If a part in question is not visible or not called out in one of the figures, some searching through the parts list will have to be done. It may be helpful to keep in mind that when the reference designators were assigned, they were generally assigned in a top to bottom left to right order.

## 6-8. SERVICE KITS

Refer to Section III and Section VIII for information about Service Kits.



Table 6-1. Reference Designations

REFERENCE DESIGNATIONS			
A .....	assembly	E .....	miscellaneous electrical part
AT .....	attenuator; isolator; termination	F .....	fuse
B .....	fan; motor	FL .....	filter
BT .....	battery	H .....	hardware
C .....	capacitor	HY .....	circulator
CP .....	coupler	J .....	electrical connector (stationary portion); jack
CR .....	diode; diode thyristor; varactor	K .....	relay
DC .....	directional coupler	L .....	coil; inductor
DL .....	delay line	M .....	meter
DS .....	annunciator; signaling device (audible or visual); lamp; LED	MP .....	miscellaneous mechanical part
P .....	electrical connector (movable portion); plug	Q .....	transistor; SCR; triode thyristor; FET
R .....	resistor	RT .....	thermistor
S .....	switch	T .....	transformer
TB .....	terminal board	TC .....	thermocouple
TP .....	test point	U .....	integrated circuit; microcircuit
V .....	electron tube	VR .....	voltage regulator; breakdown diode
W .....	cable; transmission path; wire	X .....	socket
Y .....	crystal unit (piezo-electric or quartz)	Z .....	tuned cavity; tuned circuit

Abbreviations (1 of 2)

ABBREVIATIONS			
A .....	ampere	COEF .....	coefficient
ac .....	alternating current	COM .....	common
ACCESS .....	accessory	COMP .....	composition
ADJ .....	adjustment	COMPL .....	complete
A/D .....	analog-to-digital	CONN .....	connector
AF .....	audio frequency	CP .....	cadmium plate
AFC .....	automatic frequency control	CRT .....	cathode-ray tube
AGC .....	automatic gain control	CTL .....	complementary transistor logic
AL .....	aluminum	CW .....	continuous wave
ALC .....	automatic level control	cw .....	clockwise
AM .....	amplitude modulation	cm .....	centimeter
AMPL .....	amplifier	D/A .....	digital-to-analog
APC .....	automatic phase control	dB .....	decibel
ASSY .....	assembly	dBm .....	decibel referred to 1 mW
AUX .....	auxiliary	dc .....	direct current
avg .....	average	deg .....	degree (temperature interval or difference)
AWG .....	American wire gauge	...° .....	degree (plane angle)
BAL .....	balance	°C .....	degree Celsius (centigrade)
BCD .....	binary coded decimal	°F .....	degree Fahrenheit
BD .....	board	°K .....	degree Kelvin
BECU .....	beryllium copper	DEPC .....	deposited carbon
BFO .....	beat frequency oscillator	DET .....	detector
BH .....	binder head	diam .....	diameter
BKDN .....	breakdown	DIA .....	diameter (used in parts list)
BP .....	bandpass	DIFF AMPL .....	differential amplifier
BPF .....	bandpass filter	div .....	division
BRS .....	brass	DPDT .....	double-pole, double-throw
BWO .....	backward-wave oscillator	DR .....	drive
CAL .....	calibrate	DSB .....	double sideband
ccw .....	counter-clockwise	DTL .....	diode transistor logic
CER .....	ceramic	DVM .....	digital voltmeter
CHAN .....	channel	ECL .....	emitter coupled logic
cm .....	centimeter	EMF .....	electromotive force
CMO .....	cabinet mount only	EDP .....	electronic data processing
COAX .....	coaxial	ELECT .....	electrolytic
		ENCAP .....	encapsulated
		EXT .....	external
		F .....	farad
		FET .....	field-effect transistor
		F/F .....	flip-flop
		FH .....	flat head
		FIL H .....	fillister head
		FM .....	frequency modulation
		FP .....	front panel
		FREQ .....	frequency
		FXD .....	fixed
		g .....	gram
		GE .....	germanium
		GHz .....	gigahertz
		GL .....	glass
		GRD .....	ground(ed)
		H .....	henry
		h .....	hour
		HET .....	heterodyne
		HEX .....	hexagonal
		HD .....	head
		HDW .....	hardware
		HF .....	high frequency
		HG .....	mercury
		HI .....	high
		HP .....	Hewlett-Packard
		HPF .....	high pass filter
		HR .....	hour (used in parts list)
		HV .....	high voltage
		Hz .....	Hertz
		IC .....	integrated circuit
		ID .....	inside diameter
		IF .....	intermediate frequency
		IMPG .....	impregnated
		in .....	incandescent
		INCL .....	include(s)
		INP .....	input
		INS .....	insulation
		INT .....	internal
		kg .....	kilogram
		kHz .....	kilohertz
		k .....	kilohm
		kV .....	kilovolt
		lb .....	pound
		LC .....	inductance-capacitance
		LED .....	light-emitting diode
		LF .....	low frequency
		LG .....	long
		LH .....	left hand
		LIM .....	limit
		LIN .....	linear taper (used in parts list)
		LK WASH .....	lock washer
		LO .....	low; local oscillator
		LOG .....	logarithmic taper (used in parts list)
		log .....	logarithm(ic)
		LPF .....	low pass filter
		LV .....	low voltage
		m .....	meter (distance)
		mA .....	milliampere
		MAX .....	maximum
		M .....	megohm
		MEG .....	meg (10 <sup>6</sup> ) (used in parts list)
		MET FLM .....	metal film
		MET OX .....	metallic oxide
		MF .....	medium frequency; microfarad (used in parts list)
		MFR .....	manufacturer
		mg .....	milligram
		MHz .....	megahertz
		mH .....	millihenry
		mho .....	mho
		min .....	minute (time)
		...° .....	minute (plane angle)
		MINAT .....	miniature
		mm .....	millimeter

**NOTE**

All abbreviations in the parts list will be in upper-case.

Abbreviations (2 of 2)

MOD ..... modulator	OD ..... outside diameter	PWV ..... peak working voltage	TD ..... time delay
MOM ..... momentary	OH ..... oval head	RC ..... resistance-capacitance	TERM ..... terminal
MOS ..... metal-oxide semiconductor	OP AMPL ..... operational amplifier	RECT ..... rectifier	TFT ..... thin-film transistor
ms ..... millisecond	OPT ..... option	REF ..... reference	TGL ..... toggle
MTG ..... mounting	OSC ..... oscillator	REG ..... regulated	THD ..... thread
MTR ..... meter (indicating device)	OX ..... oxide	REPL ..... replaceable	THRU ..... through
mV ..... millivolt	oz ..... ounce	RF ..... radio frequency	TI ..... titanium
mVac ..... millivolt, ac	$\Omega$ ..... ohm	RFI ..... radio frequency interference	TOL ..... tolerance
mVdc ..... millivolt, dc	P ..... peak (used in parts list)	RH ..... round head; right hand	TRIM ..... trimmer
mVpk ..... millivolt, peak	PAM ..... pulse-amplitude modulation	RLC ..... resistance-inductance-capacitance	TSTR ..... transistor
mVp-p ..... millivolt, peak-to-peak	PC ..... printed circuit	RMO ..... rack mount only	TTL ..... transistor-transistor logic
mVrms ..... millivolt, rms	PCM ..... pulse-code modulation; pulse-count modulation	rms ..... root-mean-square	TV ..... television
mW ..... milliwatt	PDM ..... pulse-duration modulation	RND ..... round	TVI ..... television interference
MUX ..... multiplex	pF ..... picofarad	ROM ..... read-only memory	TWT ..... traveling wave tube
MY ..... mylar	PH BRZ ..... phosphor bronze	R&P ..... rack and panel	U ..... micro ( $10^{-6}$ ) (used in parts list)
$\mu$ A ..... microampere	PHL ..... Phillips	RWV ..... reverse working voltage	UF ..... microfarad (used in parts list)
$\mu$ F ..... microfarad	PIN ..... positive-intrinsic-negative	S ..... scattering parameter	UHF ..... ultrahigh frequency
$\mu$ H ..... microhenry	PIV ..... peak inverse voltage	s ..... second (time)	UNDEF ..... undefined
$\mu$ mho ..... micromho	pk ..... peak	" ..... second (plane angle)	UNREG ..... unregulated
$\mu$ s ..... microsecond	PL ..... phase lock	S-B ..... slow-blow (fuse) (used in parts list)	V ..... volt
$\mu$ V ..... microvolt	PLO ..... phase lock oscillator	SCR ..... silicon controlled rectifier; screw	VA ..... voltampere
$\mu$ Vac ..... microvolt, ac	PM ..... phase modulation	SE ..... selenium	Vac ..... volts, ac
$\mu$ Vdc ..... microvolt, dc	PNP ..... positive-negative-positive	SECT ..... sections	VAR ..... variable
$\mu$ Vpk ..... microvolt, peak	P/O ..... part of	SEMICON ..... semiconductor	VCO ..... voltage-controlled oscillator
$\mu$ Vp-p ..... microvolt, peak-to-peak	POLY ..... polystyrene	SHF ..... superhigh frequency	Vdc ..... volts, dc
$\mu$ Vrms ..... microvolt, rms	PORC ..... porcelain	SI ..... silicon	VDCW ..... volts, dc, working (used in parts list)
$\mu$ W ..... microwatt	POS ..... positive; position(s) (used in parts list)	SIL ..... silver	V(F) ..... volts, filtered
nA ..... nanoampere	POSN ..... position	SL ..... slide	VFO ..... variable-frequency oscillator
NC ..... no connection	POT ..... potentiometer	SNR ..... signal-to-noise ratio	VHF ..... very-high frequency
N/C ..... normally closed	p-p ..... peak-to-peak	SPDT ..... single-pole, double-throw	Vpk ..... volts, peak
NE ..... neon	PP ..... peak-to-peak (used in parts list)	SPG ..... spring	Vp-p ..... volts, peak-to-peak
NEG ..... negative	PPM ..... pulse-position modulation	SR ..... split ring	Vrms ..... volts, rms
nF ..... nanofarad	PREAMPL ..... preamplifier	SPST ..... single-pole, single-throw	VSWR ..... voltage standing wave ratio
NI PL ..... nickel plate	PRF ..... pulse-repetition frequency	SS ..... Service Sheet	VTO ..... voltage-tune oscillator
N/O ..... normally open	PRR ..... pulse repetition rate	SSB ..... single sideband	VTVM ..... vacuum-tube voltmeter
NOM ..... nominal	ps ..... picosecond	SST ..... stainless steel	V(X) ..... volts, switched
NORM ..... normal	PT ..... point	STL ..... steel	W ..... watt
NPN ..... negative-positive-negative	PTM ..... pulse-time modulation	SQ ..... square	W/ ..... with
NPO ..... negative-positive zero (zero temperature coefficient)	PWM ..... pulse-width modulation	SWR ..... standing-wave ratio	WIV ..... working inverse voltage
NRFR ..... not recommended for field replacement		SYNC ..... synchronize	WW ..... wirewound
NSR ..... not separately replaceable		T ..... timed (slow-blow fuse)	W/O ..... without
ns ..... nanosecond		TA ..... tantalum	YIG ..... yttrium-iron-garnet
nW ..... nanowatt		TC ..... temperature compensating	Z <sub>g</sub> ..... characteristic impedance
OBD ..... order by description			

NOTE

All abbreviations in the parts list will be in upper-case.

MULTIPLIERS

Abbreviation	Prefix	Multiple
T	tera	$10^{12}$
G	giga	$10^9$
M	mega	$10^6$
k	kilo	$10^3$
da	deka	10
d	deci	$10^{-1}$
c	centi	$10^{-2}$
m	milli	$10^{-3}$
$\mu$	micro	$10^{-6}$
n	nano	$10^{-9}$
p	pico	$10^{-12}$
f	femto	$10^{-15}$
a	atto	$10^{-18}$

Table 6-2. Replaceable Parts

Reference Designation	HP Part Number	C D	Qty	Description	Mfr Code	Mfr Part Number
<b>A 1</b>						
A1	08642-60889	7	1	KEYBOARD/LCD DISPLAY MODULE	28480	08642-60889
A1	08642-69889	5	1	KEYBOARD/LCD DISPLAY MODULE (RESTORED)	28480	08642-69889
<b>A1A1</b>						
	08642-60122	1	1	KEYBOARD ASSEMBLY	28480	08642-60122
A1A1C1	0160-4835	7	154	CAPACITOR-FXD .1UF +-10% 50VDC CER	28480	0160-4835
A1A1C2	0180-2207	5	4	CAPACITOR-FXD 100UF+-10% 10VDC TA	56289	150D107X9010R2
A1A1C3				NOT ASSIGNED		
A1A1C4				NOT ASSIGNED		
A1A1C5	0160-4835	7		CAPACITOR-FXD .1UF +-10% 50VDC CER	28480	0160-4835
A1A1C6				NOT ASSIGNED		
A1A1C7	0160-4822	2	4	CAPACITOR-FXD 1000PF +-5% 100VDC CER	28480	0160-4822
A1A1C8	0180-0291	3	7	CAPACITOR-FXD 1UF+-10% 35VDC TA	56289	150D105X9035A2
A1A1C9	0160-4835	7		CAPACITOR-FXD .1UF +-10% 50VDC CER	28480	0160-4835
A1A1J1	1251-5926	3	1	CONNECTOR 50-PIN M POST TYPE	28480	1251-5926
A1A1J2				NOT ASSIGNED		
A1A1J3	1251-8821	3	1	CONN-POST TYPE .100-PIN-SPCG 5-CONT	28480	1251-8821
A1A1J4	1251-8810	0	2	CONN-POST TYPE .100-PIN-SPCG 11-CONT	28480	1251-8810
A1A1J5	1251-8810	0		CONN-POST TYPE .100-PIN-SPCG 11-CONT	28480	1251-8810
A1A1L1	9140-0238	3	1	INDUCTOR RF-CH-MLD 82UH 5% .166DX.385LG	28480	9140-0238
A1A1MP1	0590-1095	6	6	THREADED INSERT-NUT M3 X 0.5 .059-IN-LG	28480	0590-1095
A1A1Q1	1853-0281	9	9	TRANSISTOR PNP 2N2907A SI TO-18 PD=400MW	04713	2N2907A
A1A1Q2	1854-0477	7	9	TRANSISTOR NPN 2N2222A SI TO-18 PD=500MW	04713	2N2222A
A1A1R1	0757-0317	7	2	RESISTOR 1.33K 1% .125W F TC=0+-100	24546	C4-1/8-T0-1331-F
A1A1R2	0757-0436	1	1	RESISTOR 4.32K 1% .125W F TC=0+-100	24546	C4-1/8-T0-4321-F
A1A1R3				NOT ASSIGNED		
A1A1R4				NOT ASSIGNED		
A1A1R5	0698-8815	0	2	RESISTOR 1.78 1% .125W F TC=0+-100	28480	0698-8815
A1A1R6	0698-8815	0		RESISTOR 1.78 1% .125W F TC=0+-100	28480	0698-8815
A1A1R7	0698-3160	8	2	RESISTOR 31.6K 1% .125W F TC=0+-100	24546	C4-1/8-T0-3162-F
A1A1R8	1810-0286	4	3	NETWORK-RES 16-DIP10.0K OHM X 15	01121	316A103
A1A1R9	1810-0286	4		NETWORK-RES 16-DIP10.0K OHM X 15	01121	316A103
A1A1R10	1810-0286	4		NETWORK-RES 16-DIP10.0K OHM X 15	01121	316A103
A1A1R11	0757-0465	6	18	RESISTOR 100K 1% .125W F TC=0+-100	24546	C4-1/8-T0-1003-F
A1A1R12				NOT ASSIGNED		
A1A1R13	0757-0442	9	14	RESISTOR 10K 1% .125W F TC=0+-100	24546	C4-1/8-T0-1002-F
A1A1R14	0698-3156	2	3	RESISTOR 14.7K 1% .125W F TC=0+-100	24546	C4-1/8-T0-1472-F
A1A1R15	0757-0280	3	42	RESISTOR 1K 1% .125W F TC=0+-100	24546	C4-1/8-T0-1001-F
A1A1R16	0757-0280	3		RESISTOR 1K 1% .125W F TC=0+-100	24546	C4-1/8-T0-1001-F
A1A1R17	0698-3157	3	3	RESISTOR 19.6K 1% .125W F TC=0+-100	24546	C4-1/8-T0-1962-F
A1A1S1	5060-9436	7	87	PUSHBUTTON SWITCH P.C. MOUNT	28480	5060-9436
	5041-0720	4	1	KEY CAP "INSTR PRESET"	28480	5041-0720
A1A1S2	5060-9436	7		PUSHBUTTON SWITCH P.C. MOUNT	28480	5060-9436
	5041-4537	9	1	KEY CAP "SHIFT"	28480	5041-4537
A1A1S3	5060-9436	7		PUSHBUTTON SWITCH P.C. MOUNT	28480	5060-9436
	5041-1792	2	1	KEY HALF "LOCAL"	28480	5041-1792
A1A1S4	5060-9436	7		PUSHBUTTON SWITCH P.C. MOUNT	28480	5060-9436
	5041-4538	0	1	KEY CAP "MSSG"	28480	5041-4538
A1A1S5	5060-9436	7		PUSHBUTTON SWITCH P.C. MOUNT	28480	5060-9436
	5041-2719	5	1	KEY F "START FREQ"	28480	5041-2719
A1A1S6	5060-9436	7		PUSHBUTTON SWITCH P.C. MOUNT	28480	5060-9436
	5041-2823	2	1	KEYCAP "START AMPTD"	28480	5041-2823
A1A1S7	5060-9436	7		PUSHBUTTON SWITCH P.C. MOUNT	28480	5060-9436
	5041-1749	9	1	KEY CAP "FREQ"	28480	5041-1749
A1A1S8	5060-9436	7		PUSHBUTTON SWITCH P.C. MOUNT	28480	5060-9436
	5041-2820	9	1	KEY CAP "AMPTD"	28480	5041-2820
A1A1S9	5060-9436	7		PUSHBUTTON SWITCH P.C. MOUNT	28480	5060-9436
	5041-1835	4	1	KEY HALF "-"	28480	5041-1835

See introduction to this section for ordering information.

\* Indicates factory selected value

Table 6-2. Replaceable Parts

Reference Designation	HP Part Number	C D	Qty	Description	Mfr Code	Mfr Part Number
A1A1S10	5060-9436	7		PUSHBUTTON SWITCH P.C. MOUNT	28480	5060-9436
	5041-0817	0	1	KEY/HALF SK/GY 7	28480	5041-0817
A1A1S11	5060-9436	7		PUSHBUTTON SWITCH P.C. MOUNT	28480	5060-9436
	5041-0818	1	1	KEY/HALF SK/GY 8	28480	5041-0818
A1A1S12	5060-9436	7		PUSHBUTTON SWITCH P.C. MOUNT	28480	5060-9436
	5041-0816	9	2	KEY/HALF SK/GY 6	28480	5041-0816
A1A1S13	5060-9436	7		PUSHBUTTON SWITCH P.C. MOUNT	28480	5060-9436
	5041-2839	0	1	KEY CAP "GHZ DBM"	28480	5041-2839
A1A1S14	5060-9436	7		PUSHBUTTON SWITCH P.C. MOUNT	28480	5060-9436
	5041-2835	6	2	KEY CAP HZ ARROW	28480	5041-2835
A1A1S15	5060-9436	7		PUSHBUTTON SWITCH P.C. MOUNT	28480	5060-9436
	5041-2835	6		KEY CAP HZ ARROW	28480	5041-2835
A1A1S16	5060-9436	7		PUSHBUTTON SWITCH P.C. MOUNT	28480	5060-9436
	5041-0855	6	2	KEY CAP VT ARROW	28480	5041-0855
A1A1S17	5060-9436	7		PUSHBUTTON SWITCH P.C. MOUNT	28480	5060-9436
	5041-2830	1	1	KEYCAP "RF OFF/ON"	28480	5041-2830
A1A1S18	5060-9436	7		PUSHBUTTON SWITCH P.C. MOUNT	28480	5060-9436
	5041-2720	8	1	KEY F "STOP FREQ"	28480	5041-2720
A1A1S19	5060-9436	7		PUSHBUTTON SWITCH P.C. MOUNT	28480	5060-9436
	5041-2824	3	1	KEYCAP "STOP AMPD0"	28480	5041-2824
A1A1S20	5060-9436	7		PUSHBUTTON SWITCH P.C. MOUNT	28480	5060-9436
	5041-2818	5	1	KEY CAP "AM"	28480	5041-2818
A1A1S21	5060-9436	7		PUSHBUTTON SWITCH P.C. MOUNT	28480	5060-9436
	5041-2819	6	1	KEY CAP "FM"	28480	5041-2819
A1A1S22	5060-9436	7		PUSHBUTTON SWITCH P.C. MOUNT	28480	5060-9436
	5041-2837	8	1	KEY CAP "BACK SP"	28480	5041-2837
A1A1S23	5060-9436	7		PUSHBUTTON SWITCH P.C. MOUNT	28480	5060-9436
	5041-0814	7	1	KEY/HALF SK/GY 4	28480	5041-0814
A1A1S24	5060-9436	7		PUSHBUTTON SWITCH P.C. MOUNT	28480	5060-9436
	5041-0815	8	1	KEY/HALF SK/GY 5	28480	5041-0815
A1A1S25	5060-9436	7		PUSHBUTTON SWITCH P.C. MOUNT	28480	5060-9436
	5041-0816	9		KEY/HALF SK/GY 6	28480	5041-0816
A1A1S26	5060-9436	7		PUSHBUTTON SWITCH P.C. MOUNT	28480	5060-9436
	5041-2938	0	1	KEY CAP "MHZ V"	28480	5041-2938
A1A1S27	5060-9436	7		PUSHBUTTON SWITCH P.C. MOUNT	28480	5060-9436
	5041-0855	6		KEY CAP VT ARROW	28480	5041-0855
A1A1S28	5060-9436	7		PUSHBUTTON SWITCH P.C. MOUNT	28480	5060-9436
	5041-2825	4	1	KEY CAP "MOD FREQ"	28480	5041-2825
A1A1S29	5060-9436	7		PUSHBUTTON SWITCH P.C. MOUNT	28480	5060-9436
	5041-2826	5	1	KEY-CAP "INCR SET"	28480	5041-2826
A1A1S30	5060-9436	7		PUSHBUTTON SWITCH P.C. MOUNT	28480	5060-9436
	5041-0095	6	1	KEY CAP "SAVE"	28480	5041-0095
A1A1S31	5060-9436	7		PUSHBUTTON SWITCH P.C. MOUNT	28480	5060-9436
	5041-0811	4	1	KEY/HALF SK/GY 1	28480	5041-0811
A1A1S32	5060-9436	7		PUSHBUTTON SWITCH P.C. MOUNT	28480	5060-9436
	5041-0812	5	1	KEY/HALF SK/GY 2	28480	5041-0812
A1A1S33	5060-9436	7		PUSHBUTTON SWITCH P.C. MOUNT	28480	5060-9436
	5041-0813	6	1	KEY/HALF SK/GY 3	28480	5041-0813
A1A1S34	5060-9436	7		PUSHBUTTON SWITCH P.C. MOUNT	28480	5060-9436
	5041-0926	2	1	KEY CAP "KHZ MV"	28480	5041-0926
A1A1S35	5060-9436	7		PUSHBUTTON SWITCH P.C. MOUNT	28480	5060-9436
	5041-2834	5	1	KEY CAP "INT"	28480	5041-2834
A1A1S36	5060-9436	7		PUSHBUTTON SWITCH P.C. MOUNT	28480	5060-9436
	5041-2828	7	1	KEY CAP "EXT AC"	28480	5041-2828
A1A1S37	5060-9436	7		PUSHBUTTON SWITCH P.C. MOUNT	28480	5060-9436
	5041-2827	6	1	KEY CAP "EXT DC"	28480	5041-2827
A1A1S38	5060-9436	7		PUSHBUTTON SWITCH P.C. MOUNT	28480	5060-9436
	5041-2829	8	1	KEY CAP "OFF ON"	28480	5041-2829
A1A1S39	5060-9436	7		PUSHBUTTON SWITCH P.C. MOUNT	28480	5060-9436
	5041-2836	7	1	KEY CAP "SEQ"	28480	5041-2836
A1A1S40	5060-9436	7		PUSHBUTTON SWITCH P.C. MOUNT	28480	5060-9436
	5041-0775	9	1	KEY CAP "RECALL"	28480	5041-0775
A1A1S41	5060-9436	7		PUSHBUTTON SWITCH P.C. MOUNT	28480	5060-9436
	5041-0819	2	1	KEY/HALF SK/GY 0	28480	5041-0819
A1A1S42	5060-9436	7		PUSHBUTTON SWITCH P.C. MOUNT	28480	5060-9436
	5041-0808	9	1	KEY/HALF GY DOT	28480	5041-0808

See introduction to this section for ordering information.

\* Indicates factory selected value

Table 6-2. Replaceable Parts

Reference Designation	HP Part Number	C D	Qty	Description	Mfr Code	Mfr Part Number
A1A1S43	5060-9436	7		PUSHBUTTON SWITCH P.C. MOUNT	28480	5060-9436
	5041-2832	3	1	KEY-HALF "RAD ½"	28480	5041-2832
A1A1S44	5060-9436	7		PUSHBUTTON SWITCH P.C. MOUNT	28480	5060-9436
	5041-2940	4	1	KEY CAP "HZ UV"	28480	5041-2940
A1A1S45	3100-3364	2	1	SWITCH-ROTARY 16 PIN DIP 4PDT	28480	3100-3364
A1A1S46	3101-2971	7	1	SWITCH-PB SPST-NO ALTNG .125A 115VAC	28480	3101-2971
	0380-1200	0	2	STANDOFF-PRESS-IN 10MM LONG; M3 X 0.5	00000	0380-1200
	5041-0944	4	1	KEY CAP "POWER"	28480	5041-0944
	0515-1227	8		SCREW-MACH M3 X 0.5 6MM-LG 90-DEG-FLH-HD	28480	0515-1227
	08642-60085	5		WIRE ASSY	28480	08642-60085
A1A1S47	3101-2243	6	1	SWITCH-RKR DIP-RKR-ASSY 8-1A .05A 30VDC	28480	3101-2243
A1A1TP1	0360-0535	0	125	TERMINAL TEST POINT PCB	00000	ORDER BY DESCRIPTION
A1A1TP2	0360-0535	0		TERMINAL TEST POINT PCB	00000	ORDER BY DESCRIPTION
A1A1TP3	0360-0535	0		TERMINAL TEST POINT PCB	00000	ORDER BY DESCRIPTION
A1A1TP4	0360-0535	0		TERMINAL TEST POINT PCB	00000	ORDER BY DESCRIPTION
A1A1TP5	0360-0535	0		TERMINAL TEST POINT PCB	00000	ORDER BY DESCRIPTION
A1A1TP6	0360-0535	0		TERMINAL TEST POINT PCB	00000	ORDER BY DESCRIPTION
A1A1U1-U12				NOT ASSIGNED		
A1A1U13	1820-1423	4	5	IC MV TTL LS MONOSTBL RETRIG DUAL	01295	SN74LS123N
A1A1U14	1820-2466	7	1	IC TIMER CMOS	32293	ICM7555IPA
A1A1U15	1820-1197	9	9	IC GATE TTL LS NAND QUAD 2-INP	01295	SN74LS00N
A1A1U16	1820-1207	2	1	IC GATE TTL LS NAND 8-INP	01295	SN74LS30N
A1A1U17	1820-1408	5	1	IC GATE CMOS AND TPL 3-INP	3L585	CD4073BE
A1A1U18				NOT ASSIGNED		
A1A1U19	1820-1112	8	7	IC FF TTL LS D-TYPE POS-EDGE-TRIG	01295	SN74LS74AN
A1A1U20	1820-1112	8		IC FF TTL LS D-TYPE POS-EDGE-TRIG	01295	SN74LS74AN

See introduction to this section for ordering information.

\* Indicates factory selected value



Table 6-2. Replaceable Parts

Reference Designation	HP Part Number	C D	Qty	Description	Mfr Code	Mfr Part Number
<b>A1A2</b>	08642-60075	3	1	LCD DISPLAY ASSEMBLY	28480	08642-60075
A1A2DS1	2140-0536	7	2	NOT ASSIGNED	28480	2140-0536
A1A2DS2	2140-0536	7		LAMP-INCAND 5VDC 115MA T-1-BULB	28480	2140-0536
A1A2DS3	2140-0536	7		LAMP-INCAND 5VDC 115MA T-1-BULB	28480	2140-0536
A1A2MP1	08642-40060	4	2	LAMP COVER	28480	08642-40060
	0515-1083	4	14	SCREW-MACH M1.6 X 0.35 10MM-LG PAN-HD	28480	0515-1083
	3050-1031	9	1	WASHER-FL MTLC NO. 0 .065-IN-ID	28480	3050-1031

See introduction to this section for ordering information.

\* Indicates factory selected value





Table 6-2. Replaceable Parts

Reference Designation	HP Part Number	C D	Qty	Description	Mfr Code	Mfr Part Number
<b>A 2</b>						
A2	08642-60890	0	1	MODULATION MODULE	28480	08642-60890
A2	08642-69890	8	1	MODULATION MODULE (RESTORED)	28480	08642-69890
A2C1	0160-4835	7		CAPACITOR-FXD .1UF +-10% 50VDC CER	28480	0160-4835
A2C2	0160-4835	7		CAPACITOR-FXD .1UF +-10% 50VDC CER	28480	0160-4835
A2C3	0160-3661	5	2	CAPACITOR-FXD .1UF +-5% 50VDC MET-POLYC	28480	0160-3661
A2C4	0160-5543	6	2	CAPACITOR-FXD .018UF +-5% 100VDC	28480	0160-5543
A2C5	0160-6021	7	2	CAPACITOR-FXD 2700PF +-2% 200VDC	28480	0160-6021
A2C6	0160-5404	8	2	CAPACITOR-FXD 360PF +-5% 100VDC CER	28480	0160-5404
A2C7	0160-4803	9	3	CAPACITOR-FXD 68PF +-5% 100VDC CER 0+-30	28480	0160-4803
A2C8	0180-0491	5	87	CAPACITOR-FXD 10UF+-20% 25VDC TA	28480	0180-0491
A2C9	0180-0491	5		CAPACITOR-FXD 10UF+-20% 25VDC TA	28480	0180-0491
A2C10	0160-4502	5	4	CAPACITOR-FXD 390PF +-5% 100VDC CER	28480	0160-4502
A2C11	0180-0491	5		CAPACITOR-FXD 10UF+-20% 25VDC TA	28480	0180-0491
A2C12	0180-0491	5		CAPACITOR-FXD 10UF+-20% 25VDC TA	28480	0180-0491
A2C13	0180-0491	5		CAPACITOR-FXD 10UF+-20% 25VDC TA	28480	0180-0491
A2C14	0160-4765	2	2	CAPACITOR-FXD 36PF +-5% 200VDC CER 0+-30	28480	0160-4765
A2C15	0180-0491	5		CAPACITOR-FXD 10UF+-20% 25VDC TA	28480	0180-0491
A2C16	0160-4527	4	12	CAPACITOR-FXD 56PF +-5% 200VDC CER 0+-30	28480	0160-4527
A2C17	0180-0491	5		CAPACITOR-FXD 10UF+-20% 25VDC TA	28480	0180-0491
A2C18	0180-0491	5		CAPACITOR-FXD 10UF+-20% 25VDC TA	28480	0180-0491
A2C19	0160-3874	2		CAPACITOR-FXD 10PF +- .5PF 200VDC CER	28480	0160-3874
A2C20	0160-4835	7		CAPACITOR-FXD .1UF +-10% 50VDC CER	28480	0160-4835
A2C21	0160-3661	5		CAPACITOR-FXD .1UF +-5% 50VDC MET-POLYC	28480	0160-3661
A2C22	0160-5543	6		CAPACITOR-FXD .018UF +-5% 100VDC	28480	0160-5543
A2C23	0160-6021	7		CAPACITOR-FXD 2700PF +-2% 200VDC	28480	0160-6021
A2C24	0160-5404	8		CAPACITOR-FXD 360PF +-5% 100VDC CER	28480	0160-5404
A2C25	0160-4803	9		CAPACITOR-FXD 68PF +-5% 100VDC CER 0+-30	28480	0160-4803
A2C26	0180-0491	5		CAPACITOR-FXD 10UF+-20% 25VDC TA	28480	0180-0491
A2C27	0180-0491	5		CAPACITOR-FXD 10UF+-20% 25VDC TA	28480	0180-0491
A2C28	0160-4502	5		CAPACITOR-FXD 390PF +-5% 100VDC CER	28480	0160-4502
A2C29	0180-0491	5		CAPACITOR-FXD 10UF+-20% 25VDC TA	28480	0180-0491
A2C30	0180-0491	5		CAPACITOR-FXD 10UF+-20% 25VDC TA	28480	0180-0491
A2C31	0180-0491	5		CAPACITOR-FXD 10UF+-20% 25VDC TA	28480	0180-0491
A2C32	0180-0491	5		CAPACITOR-FXD 10UF+-20% 25VDC TA	28480	0180-0491
A2C33	0180-0491	5		CAPACITOR-FXD 10UF+-20% 25VDC TA	28480	0180-0491
A2C34	0180-0491	5		CAPACITOR-FXD 10UF+-20% 25VDC TA	28480	0180-0491
A2C35	0180-0491	5		CAPACITOR-FXD 10UF+-20% 25VDC TA	28480	0180-0491
A2C36	0160-4846	0	1	CAPACITOR-FXD 1500PF +-5% 100VDC CER	28480	0160-4846
A2C37	0180-0491	5		CAPACITOR-FXD 10UF+-20% 25VDC TA	28480	0180-0491
A2C38	0180-0491	5		CAPACITOR-FXD 10UF+-20% 25VDC TA	28480	0180-0491
A2C39	0180-0491	5		CAPACITOR-FXD 10UF+-20% 25VDC TA	28480	0180-0491
A2C40	0160-4832	4	47	CAPACITOR-FXD .01UF +-10% 100VDC CER	28480	0160-4832
A2C41	0160-4387	4		CAPACITOR-FXD 47PF +-5% 200VDC CER 0+-30	28480	0160-4387
A2C42	0160-4040	6	45	CAPACITOR-FXD 1000PF +-5% 100VDC CER	28480	0160-4040
A2C43	0180-0491	5		CAPACITOR-FXD 10UF+-20% 25VDC TA	28480	0180-0491
A2C44	0180-0491	5		CAPACITOR-FXD 10UF+-20% 25VDC TA	28480	0180-0491
A2C45	0180-0491	5		CAPACITOR-FXD 10UF+-20% 25VDC TA	28480	0180-0491
A2C46	0180-2141	6	1	CAPACITOR-FXD 3.3UF+-10% 50VDC TA	56289	150D335X9050B2
A2C47	0160-4040	6		CAPACITOR-FXD 1000PF +-5% 100VDC CER	28480	0160-4040
A2C48	0160-0572	1	1	CAPACITOR-FXD 2200PF +-20% 100VDC CER	28480	0160-0572
A2C49	0160-4835	7		CAPACITOR-FXD .1UF +-10% 50VDC CER	28480	0160-4835
A2C50	0160-4835	7		CAPACITOR-FXD .1UF +-10% 50VDC CER	28480	0160-4835
A2C51	0180-2506	7	4	CAPACITOR-FXD 470UF+50-10% 25VDC AL	28480	0180-2506
A2C52	0180-2506	7		CAPACITOR-FXD 470UF+50-10% 25VDC AL	28480	0180-2506
A2C53	0160-4835	7		CAPACITOR-FXD .1UF +-10% 50VDC CER	28480	0160-4835
A2C54	0160-4835	7		CAPACITOR-FXD .1UF +-10% 50VDC CER	28480	0160-4835
A2C55	0180-0491	5		CAPACITOR-FXD 10UF+-20% 25VDC TA	28480	0180-0491
A2C56	0180-0491	5		CAPACITOR-FXD 10UF+-20% 25VDC TA	28480	0180-0491
A2C57	0160-4835	7		CAPACITOR-FXD .1UF +-10% 50VDC CER	28480	0160-4835
A2C58	0160-4835	7		CAPACITOR-FXD .1UF +-10% 50VDC CER	28480	0160-4835
A2C59	0160-4835	7		CAPACITOR-FXD .1UF +-10% 50VDC CER	28480	0160-4835
A2C60	0160-4835	7		CAPACITOR-FXD .1UF +-10% 50VDC CER	28480	0160-4835

See introduction to this section for ordering information.

\* Indicates factory selected value

Table 6-2. Replaceable Parts

Reference Designation	HP Part Number	C D	Qty	Description	Mfr Code	Mfr Part Number
A2C56	0180-0491	5		CAPACITOR-FXD 10UF+-20% 25VDC TA	28480	0180-0491
<i>2724A TO 2514A</i>						
A2C57	0160-4835	7		CAPACITOR-FXD .1UF +-10% 50VDC CER	28480	0160-4835
A2C58	0160-4835	7		CAPACITOR-FXD .1UF +-10% 50VDC CER	28480	0160-4835
A2C59	0160-4835	7		CAPACITOR-FXD .1UF +-10% 50VDC CER	28480	0160-4835
A2C60	0160-4835	7		CAPACITOR-FXD .1UF +-10% 50VDC CER	28480	0160-4835
<i>2714A AND ABOVE</i>						
A2C57				NOT ASSIGNED		
A2C58				NOT ASSIGNED		
A2C59				NOT ASSIGNED		
A2C60				NOT ASSIGNED		
A2C61	0180-0491	5		CAPACITOR-FXD 10UF+-20% 25VDC TA	28480	0180-0491
A2C62	0180-0491	5		CAPACITOR-FXD 10UF+-20% 25VDC TA	28480	0180-0491
A2C63	0160-4835	7		CAPACITOR-FXD .1UF +-10% 50VDC CER	28480	0160-4835
A2C64	0160-4835	7		CAPACITOR-FXD .1UF +-10% 50VDC CER	28480	0160-4835
A2C65	0160-4494	4	3	CAPACITOR-FXD 39PF +-5% 200VDC CER 0+-30	28480	0160-4494
A2C66	0180-0116	1	7	CAPACITOR-FXD 6.8UF+-10% 35VDC TA	56289	150D685X9035B2
A2C67	0160-4527	4		CAPACITOR-FXD 56PF +-5% 200VDC CER 0+-30	28480	0160-4527
A2C68	0160-3874	2	24	CAPACITOR-FXD 10PF +-.5PF 200VDC CER	28480	0160-3874
A2C69	0160-4835	7		CAPACITOR-FXD .1UF +-10% 50VDC CER	28480	0160-4835
A2C70	0160-4835	7		CAPACITOR-FXD .1UF +-10% 50VDC CER	28480	0160-4835
A2C71	0160-4835	7		CAPACITOR-FXD .1UF +-10% 50VDC CER	28480	0160-4835
A2C72	0180-0197	8	2	CAPACITOR-FXD 2.2UF+-10% 20VDC TA	56289	150D225X9020A2
A2C73	0180-0197	8		CAPACITOR-FXD 2.2UF+-10% 20VDC TA	56289	150D225X9020A2
A2C74	0180-0491	5		CAPACITOR-FXD 10UF+-20% 25VDC TA	28480	0180-0491
A2C75	0180-0491	5		CAPACITOR-FXD 10UF+-20% 25VDC TA	28480	0180-0491
A2C76	0180-0491	5		CAPACITOR-FXD 10UF+-20% 25VDC TA	28480	0180-0491
<i>2427A TO 2513A</i>						
A2C77	0160-5412	8	1	CAPACITOR-FXD 16PF +-5% 100VDC CER 0+-30	28480	0160-5412
<i>2514A AND ABOVE</i>						
A2C77	0160-4523	0	1	CAPACITOR-FXD 16PF +-5% 200VDC CER 0+-30	28480	0160-4523
A2C78	0180-0491	5		CAPACITOR-FXD 10UF+-20% 25VDC TA	28480	0180-0491
A2C79	0160-4835	7		CAPACITOR-FXD .1UF +-10% 50VDC CER	28480	0160-4835
A2C80				NOT ASSIGNED		
A2C81	0160-4535	4	11	CAPACITOR-FXD 1UF +-10% 50VDC CER	28480	0160-4535
A2C82	0180-0491	5		CAPACITOR-FXD 10UF+-20% 25VDC TA	28480	0180-0491
A2C83	0180-0491	5		CAPACITOR-FXD 10UF+-20% 25VDC TA	28480	0180-0491
A2C84	0160-4835	7		CAPACITOR-FXD .1UF +-10% 50VDC CER	28480	0160-4835
A2C85	0180-2506	7		CAPACITOR-FXD 470UF+50-10% 25VDC AL	28480	0180-2506
A2C86	0180-2506	7		CAPACITOR-FXD 470UF+50-10% 25VDC AL	28480	0180-2506
A2C87	0160-4835	7		CAPACITOR-FXD .1UF +-10% 50VDC CER	28480	0160-4835
A2C88	0180-0491	5		CAPACITOR-FXD 10UF+-20% 25VDC TA	28480	0180-0491
A2C89	0180-0491	5		CAPACITOR-FXD 10UF+-20% 25VDC TA	28480	0180-0491
A2C90	0160-4765	2		CAPACITOR-FXD 36PF +-5% 200VDC CER 0+-30	28480	0160-4765
A2C91	0180-0491	5		CAPACITOR-FXD 10UF+-20% 25VDC TA	28480	0180-0491
A2C92	0180-0491	5		CAPACITOR-FXD 10UF+-20% 25VDC TA	28480	0180-0491
<i>2427A TO 2514A</i>						
A2C93	0160-4835	7		CAPACITOR-FXD .1UF +-10% 50VDC CER	28480	0160-4835
A2C94	0160-4835	7		CAPACITOR-FXD .1UF +-10% 50VDC CER	28480	0160-4835
<i>2714A AND ABOVE</i>						
A2C93				NOT ASSIGNED		
A2C94				NOT ASSIGNED		
A2C95-C100				NOT ASSIGNED		
A2C101	0160-6023	9	1	CAPACITOR-FXD 2200PF +-1% 200VDC	28480	0160-6023
A2C102	0180-0491	5		CAPACITOR-FXD 10UF+-20% 25VDC TA	28480	0180-0491
A2C103	0180-0491	5		CAPACITOR-FXD 10UF+-20% 25VDC TA	28480	0180-0491
A2C104	0180-0491	5		CAPACITOR-FXD 10UF+-20% 25VDC TA	28480	0180-0491
A2C105	0160-4527	4		CAPACITOR-FXD 56PF +-5% 200VDC CER 0+-30	28480	0160-4527
A2C106	0180-0491	5		CAPACITOR-FXD 10UF+-20% 25VDC TA	28480	0180-0491
A2C107	0180-0491	5		CAPACITOR-FXD 10UF+-20% 25VDC TA	28480	0180-0491
A2C108	0160-3874	2		CAPACITOR-FXD 10PF +-.5PF 200VDC CER	28480	0160-3874
A2C109	0160-4494	4		CAPACITOR-FXD 39PF +-5% 200VDC CER 0+-30	28480	0160-4494
A2C110	0180-0491	5		CAPACITOR-FXD 10UF+-20% 25VDC TA	28480	0180-0491
A2C111	0180-0491	5		CAPACITOR-FXD 10UF+-20% 25VDC TA	28480	0180-0491
A2C112-C117				NOT ASSIGNED		
A2C118	0180-0116	1		CAPACITOR-FXD 6.8UF+-10% 35VDC TA	56289	150D685X9035B2
A2C119	0160-4835	7		CAPACITOR-FXD .1UF +-10% 50VDC CER	28480	0160-4835
A2C120	0180-0116	1		CAPACITOR-FXD 6.8UF+-10% 35VDC TA	56289	150D685X9035B2

See introduction to this section for ordering information.

\* Indicates factory selected value

Table 6-2. Replaceable Parts

Reference Designation	HP Part Number	C D	Qty	Description	Mfr Code	Mfr Part Number
A2C121	0160-4835	7	2	CAPACITOR-FXD 1UF +-10% 50VDC CER	28480	0160-4835
A2C122	0180-0229	7		CAPACITOR-FXD 33UF+-10% 10VDC TA	56289	150D336X9010B2
A2C123	0160-4835	7		CAPACITOR-FXD .1UF +-10% 50VDC CER	28480	0160-4835
A2C124	0180-0229	7		CAPACITOR-FXD 33UF+-10% 10VDC TA	56289	150D336X9010B2
A2C125	0160-4835	7		CAPACITOR-FXD .1UF +-10% 50VDC CER	28480	0160-4835
A2C126	0180-0116	1		CAPACITOR-FXD 6.8UF+-10% 35VDC TA	56289	150D685X9035B2
A2C127	0160-4835	7		CAPACITOR-FXD .1UF +-10% 50VDC CER	28480	0160-4835
A2C128	0160-4835	7		CAPACITOR-FXD .1UF +-10% 50VDC CER	28480	0160-4835
A2C129	0160-4835	7		CAPACITOR-FXD .1UF +-10% 50VDC CER	28480	0160-4835
A2C130	0160-4835	7		CAPACITOR-FXD .1UF +-10% 50VDC CER	28480	0160-4835
A2C131	0160-4835	7		CAPACITOR-FXD .1UF +-10% 50VDC CER	28480	0160-4835
A2C132	0160-4835	7		CAPACITOR-FXD .1UF +-10% 50VDC CER	28480	0160-4835
A2C133	0160-4835	7		CAPACITOR-FXD .1UF +-10% 50VDC CER	28480	0160-4835
A2C134				NOT ASSIGNED		
A2C135				NOT ASSIGNED		
A2C136	0160-3874	2	4	CAPACITOR-FXD 10PF +- .5PF 200VDC CER	28480	0160-3874
A2C137	0160-4040	6		CAPACITOR-FXD 1000PF +-5% 100VDC CER	28480	0160-4040
A2C138	0160-4385	2		CAPACITOR-FXD 15PF +-5% 200VDC CER 0+-30	28480	0160-4385
A2C139	0160-4385	2		CAPACITOR-FXD 15PF +-5% 200VDC CER 0+-30	28480	0160-4385
A2C140	0180-0491	5		CAPACITOR-FXD 10UF+-20% 25VDC TA	28480	0180-0491
2427A TO 2513A				NOT ASSIGNED		
A2C141				NOT ASSIGNED		
A2C142				NOT ASSIGNED		
A2C143				NOT ASSIGNED		
2514A AND ABOVE						
A2C141	0180-0491	5		CAPACITOR-FXD 10UF+-20% 25VDC TA	28480	0180-0491
A2C142	0180-0491	5		CAPACITOR-FXD 10UF+-20% 25VDC TA	28480	0180-0491
A2C143	0160-4389	6		CAPACITOR-FXD 100PF +-5PF 200VDC CER	28480	0160-4389
2427A TO 2514A				NOT ASSIGNED		
A2C144-C151				NOT ASSIGNED		
2714A AND ABOVE						
A2C144	0160-4835	7		CAPACITOR-FXD .1UF +-10% 50VDC CER	28480	0160-4835
A2C145	0160-4835	7		CAPACITOR-FXD .1UF +-10% 50VDC CER	28480	0160-4835
A2C146	0160-4835	7		CAPACITOR-FXD .1UF +-10% 50VDC CER	28480	0160-4835
A2C147	0160-4835	7		CAPACITOR-FXD .1UF +-10% 50VDC CER	28480	0160-4835
A2C148	0160-4835	7		CAPACITOR-FXD .1UF +-10% 50VDC CER	28480	0160-4835
A2C149	0160-4835	7		CAPACITOR-FXD .1UF +-10% 50VDC CER	28480	0160-4835
A2C150	0160-4835	7		CAPACITOR-FXD .1UF +-10% 50VDC CER	28480	0160-4835
A2C151	0160-4835	7		CAPACITOR-FXD .1UF +-10% 50VDC CER	28480	0160-4835
A2CR1	1901-1128	8	4	DIODE-SCHOTTKY 40V 1A	28480	1901-1128
A2CR2	1901-1128	8		DIODE-SCHOTTKY 40V 1A	28480	1901-1128
A2CR3	1901-0050	3	77	DIODE-SWITCHING 80V 200MA 2NS DO-35	28480	1901-0050
A2CR4	1901-0050	3		DIODE-SWITCHING 80V 200MA 2NS DO-35	28480	1901-0050
A2CR5	1901-0050	3		DIODE-SWITCHING 80V 200MA 2NS DO-35	28480	1901-0050
A2CR6	1901-0050	3		DIODE-SWITCHING 80V 200MA 2NS DO-35	28480	1901-0050
A2CR7	1901-0518	8	13	DIODE-SM SIG SCHOTTKY	28480	1901-0518
A2CR8	1901-0880	7		DIODE-GEN PRP 125MA DO-35	28480	1901-0880
A2CR9	1901-0880	7	10	DIODE-GEN PRP 125MA DO-35	28480	1901-0880
A2CR10	1901-0880	7	10	DIODE-GEN PRP 125MA DO-35	28480	1901-0880
A2CR11	1901-0880	7	10	DIODE-GEN PRP 125MA DO-35	28480	1901-0880
A2CR12	1901-0880	7	10	DIODE-GEN PRP 125MA DO-35	28480	1901-0880
A2CR13	1901-0880	7	10	DIODE-GEN PRP 125MA DO-35	28480	1901-0880
A2CR14	1901-0880	7	10	DIODE-GEN PRP 125MA DO-35	28480	1901-0880
A2CR15				NOT ASSIGNED		
A2CR16	1901-0880	7	10	DIODE-GEN PRP 125MA DO-35	28480	1901-0880
A2CR17				NOT ASSIGNED		
A2CR18	1901-0880	7	10	DIODE-GEN PRP 125MA DO-35	28480	1901-0880
A2CR19	1901-0880	7	10	DIODE-GEN PRP 125MA DO-35	28480	1901-0880
2427A TO 2514A						
A2CR20	1901-0518	8		DIODE-SM SIG SCHOTTKY	28480	1901-0518
A2CR21	1901-0518	8		DIODE-SM SIG SCHOTTKY	28480	1901-0518
2714A AND ABOVE						
A2CR20	1901-1085	6		DIODE-SM SIG SCHOTTKY	28480	1901-1085
A2CR21	1901-1085	6		DIODE-SM SIG SCHOTTKY	28480	1901-1085
A2J1	1251-8812	2	2	CONN-POST TYPE .100-PIN-SPCG 20-CONT	28480	1251-8812
A2J2	1250-0836	2		CONNECTOR-RF SMC M PC 50-OHM	28480	1250-0836
A2J3	1250-0836	2	7	CONNECTOR-RF SMC M PC 50-OHM	28480	1250-0836
A2J4	1250-0836	2		CONNECTOR-RF SMC M PC 50-OHM	28480	1250-0836
A2J5	1250-0836	2		CONNECTOR-RF SMC M PC 50-OHM	28480	1250-0836
A2J6	1250-0836	2		CONNECTOR-RF SMC M PC 50-OHM	28480	1250-0836
A2J7	1250-0836	2		CONNECTOR-RF SMC M PC 50-OHM	28480	1250-0836
A2J8	1250-0836	2		CONNECTOR-RF SMC M PC 50-OHM	28480	1250-0836

See introduction to this section for ordering information.

\* Indicates factory selected value

Table 6-2. Replaceable Parts

Reference Designation	HP Part Number	C D	Qty	Description	Mfr Code	Mfr Part Number
A2K1	0490-1426	5	6	RELAY 1C 12VDC-COIL 1A 110VAC	28480	0490-1426
A2K2	0490-1426	5		RELAY 1C 12VDC-COIL 1A 110VAC	28480	0490-1426
A2K3	0490-1426	5		RELAY 1C 12VDC-COIL 1A 110VAC	28480	0490-1426
A2K4	0490-1426	5		RELAY 1C 12VDC-COIL 1A 110VAC	28480	0490-1426
A2K5	0490-1426	5		RELAY 1C 12VDC-COIL 1A 110VAC	28480	0490-1426
A2K6	0490-1426	5		RELAY 1C 12VDC-COIL 1A 110VAC	28480	0490-1426
2427A TO 2514A A2K7-K14 2714A AND ABOVE				NOT ASSIGNED		
A2K7	0490-1585	7		RELAY 1C 12VDC-COIL 2A 250VAC	01850	DS1E-S-DC12V
A2K8	0490-1585	7		RELAY 1C 12VDC-COIL 2A 250VAC	01850	DS1E-S-DC12V
A2K9	0490-1585	7		RELAY 1C 12VDC-COIL 2A 250VAC	01850	DS1E-S-DC12V
A2K10	0490-1585	7		RELAY 1C 12VDC-COIL 2A 250VAC	01850	DS1E-S-DC12V
A2K11	0490-1585	7		RELAY 1C 12VDC-COIL 2A 250VAC	01850	DS1E-S-DC12V
A2K12	0490-1585	7		RELAY 1C 12VDC-COIL 2A 250VAC	01850	DS1E-S-DC12V
A2K13	0490-1585	7		RELAY 1C 12VDC-COIL 2A 250VAC	01850	DS1E-S-DC12V
A2K14	0490-1585	7		RELAY 1C 12VDC-COIL 2A 250VAC	01850	DS1E-S-DC12V
A2MP1	1400-0249	0		CABLE TIE .062-.625-DIA .091-WD NYL	06383	PLT1M-8
A2R1	0698-7195	7	54	RESISTOR 19.6 1% .05W F TC=0+-100	24546	C3-1/8-T0-19R6-F
A2R2	0698-7195	7		RESISTOR 19.6 1% .05W F TC=0+-100	24546	C3-1/8-T0-19R6-F
A2R3	0698-7195	7		RESISTOR 19.6 1% .05W F TC=0+-100	24546	C3-1/8-T0-19R6-F
A2R4	0698-7195	7		RESISTOR 19.6 1% .05W F TC=0+-100	24546	C3-1/8-T0-19R6-F
2427A TO 2514A A2R5	0698-7245	8	14	RESISTOR 2.37K 1% .05W F TC=0+-100	24546	C3-1/8-T0-2371-F
2714A AND ABOVE A2R5	0698-7242	5		RESISTOR 1.78K 1% .05W F TC=0+-100	24546	C3-1/8-T0-1781-F
2427A TO 2514A A2R6	0698-7235	6	2	RESISTOR 909 1% .05W F TC=0+-100	24546	C3-1/8-T0-909R-F
2714A AND ABOVE A2R6	0698-7225	4		RESISTOR 348 1% .05W F TC=0+-100	24546	C3-1/8-T0-1781-F
A2R7	0698-7195	7	2	RESISTOR 19.6 1% .05W F TC=0+-100	24546	C3-1/8-T0-19R6-F
A2R8	2100-2030	6		RESISTOR-TRMR 20K 10% C TOP-ADJ 1-TRN	73138	82PR20K
A2R9	0698-7260	7		RESISTOR 10K 1% .05W F TC=0+-100	24546	C3-1/8-T0-1002-F
A2R10	0698-7195	7		RESISTOR 19.6 1% .05W F TC=0+-100	24546	C3-1/8-T0-19R6-F
A2R11	0698-7195	7		RESISTOR 19.6 1% .05W F TC=0+-100	24546	C3-1/8-T0-19R6-F
A2R12	0698-7249	2	2	RESISTOR 3.48K 1% .05W F TC=0+-100	24546	C3-1/8-T0-3481-F
A2R13	0698-7278	7		RESISTOR 56.2K 1% .05W F TC=0+-100	24546	C3-1/8-T0-5622-F
A2R14	0698-7260	7	1	RESISTOR 10K 1% .05W F TC=0+-100	24546	C3-1/8-T0-1002-F
A2R15	0698-7195	7		RESISTOR 19.6 1% .05W F TC=0+-100	24546	C3-1/8-T0-19R6-F
A2R16	0698-7245	8		RESISTOR 2.37K 1% .05W F TC=0+-100	24546	C3-1/8-T0-2371-F
A2R17	0698-7195	7		RESISTOR 19.6 1% .05W F TC=0+-100	24546	C3-1/8-T0-19R6-F
A2R18	0698-7195	7		RESISTOR 19.6 1% .05W F TC=0+-100	24546	C3-1/8-T0-19R6-F
A2R19	0698-6261	6	3	RESISTOR 600 .25% .25W F TC=0+-50	28480	0698-6261
A2R20	0698-7195	7		RESISTOR 19.6 1% .05W F TC=0+-100	24546	C3-1/8-T0-19R6-F
A2R21	0698-7195	7		RESISTOR 19.6 1% .05W F TC=0+-100	24546	C3-1/8-T0-19R6-F
A2R22	0698-7195	7		RESISTOR 19.6 1% .05W F TC=0+-100	24546	C3-1/8-T0-19R6-F
A2R23	0698-7195	7		RESISTOR 19.6 1% .05W F TC=0+-100	24546	C3-1/8-T0-19R6-F
2427A TO 2514A A2R24	0698-7245	8		RESISTOR 2.37K 1% .05W F TC=0+-100	24546	C3-1/8-T0-2371-F
A2R25	0698-7235	6		RESISTOR 909 1% .05W F TC=0+-100	24546	C3-1/8-T0-909R-F
2717A AND ABOVE A2R24	0698-7242	5		RESISTOR 1.78K 1% .05W F TC=0+-100	24546	C3-1/8-T0-1781-F
A2R25	0698-7225	4		RESISTOR 348 1% .05W F TC=0+-100	24546	C3-1/8-T0-1781-F
A2R26	0698-7195	7		RESISTOR 19.6 1% .05W F TC=0+-100	24546	C3-1/8-T0-19R6-F
A2R27	2100-2030	6		RESISTOR-TRMR 20K 10% C TOP-ADJ 1-TRN	73138	82PR20K
A2R28	0698-7195	7		RESISTOR 19.6 1% .05W F TC=0+-100	24546	C3-1/8-T0-19R6-F
A2R29	0698-7195	7		RESISTOR 19.6 1% .05W F TC=0+-100	24546	C3-1/8-T0-19R6-F
A2R30	0698-7267	4	3	RESISTOR 19.6K 1% .05W F TC=0+-100	24546	C3-1/8-T0-1962-F
A2R31	0698-7267	4		RESISTOR 19.6K 1% .05W F TC=0+-100	24546	C3-1/8-T0-1962-F
A2R32	0698-7246	9	7	RESISTOR 2.61K 1% .05W F TC=0+-100	24546	C3-1/8-T0-2611-F
A2R33	0698-7246	9		RESISTOR 2.61K 1% .05W F TC=0+-100	24546	C3-1/8-T0-2611-F
A2R34	0698-7247	0	7	RESISTOR 2.87K 1% .05W F TC=0+-100	24546	C3-1/8-T0-2871-F
A2R35	0698-7195	7		RESISTOR 19.6 1% .05W F TC=0+-100	24546	C3-1/8-T0-19R6-F
A2R36	0698-7195	7		RESISTOR 19.6 1% .05W F TC=0+-100	24546	C3-1/8-T0-19R6-F
A2R37	0698-7256	1	12	RESISTOR 6.81K 1% .05W F TC=0+-100	24546	C3-1/8-T0-6811-F
A2R38	0698-7260	7		RESISTOR 10K 1% .05W F TC=0+-100	24546	C3-1/8-T0-1002-F
A2R39	0698-7253	8	37	RESISTOR 5.11K 1% .05W F TC=0+-100	24546	C3-1/8-T0-5111-F
A2R40	0698-7248	1		RESISTOR 3.16K 1% .05W F TC=0+-100	24546	C3-1/8-T0-3161-F
A2R41	0698-7260	7		RESISTOR 10K 1% .05W F TC=0+-100	24546	C3-1/8-T0-1002-F
A2R42	0698-7253	8		RESISTOR 5.11K 1% .05W F TC=0+-100	24546	C3-1/8-T0-5111-F
A2R43	0698-7253	8		RESISTOR 5.11K 1% .05W F TC=0+-100	24546	C3-1/8-T0-5111-F
A2R44	0698-7195	7		RESISTOR 19.6 1% .05W F TC=0+-100	24546	C3-1/8-T0-19R6-F
A2R45	0698-7195	7		RESISTOR 19.6 1% .05W F TC=0+-100	24546	C3-1/8-T0-19R6-F

See introduction to this section for ordering information.

\* Indicates factory selected value

Table 6-2. Replaceable Parts

Reference Designation	HP Part Number	C D	Qty	Description	Mfr Code	Mfr Part Number
A2R86	0698-7195	7	3	RESISTOR 19.6 1% .05W F TC=0+-100	24546	C3-1/8-T0-19R6-F
A2R87	0698-7579	1		RESISTOR 7.853K .1% .125W F TC=0+-25	19701	MF4C1/8-T9-7853R-B
A2R88	0698-7248	1		RESISTOR 3.16K 1% .05W F TC=0+-100	24546	C3-1/8-T0-3161-F
A2R89	0698-7195	7		RESISTOR 19.6 1% .05W F TC=0+-100	24546	C3-1/8-T0-19R6-F
A2R90	0698-7245	8		RESISTOR 2.37K 1% .05W F TC=0+-100	24546	C3-1/8-T0-2371-F
A2R91	0698-7195	7	6	RESISTOR 19.6 1% .05W F TC=0+-100	24546	C3-1/8-T0-19R6-F
A2R92	0698-7195	7		RESISTOR 19.6 1% .05W F TC=0+-100	24546	C3-1/8-T0-19R6-F
A2R93	0698-7260	7		RESISTOR 10K 1% .05W F TC=0+-100	24546	C3-1/8-T0-1002-F
A2R94	0698-3453	2		RESISTOR 196K 1% .125W F TC=0+-100	24546	C4-1/8-T0-1963-F
A2R95	0698-7236	7		RESISTOR 1K 1% .05W F TC=0+-100	24546	C3-1/8-T0-1001-F
A2R96	0698-3453	2	NOT ASSIGNED	RESISTOR 196K 1% .125W F TC=0+-100	24546	C4-1/8-T0-1963-F
A2R97				NOT ASSIGNED		
A2R98				NOT ASSIGNED		
A2R99	0698-7195	7	RESISTOR 19.6 1% .05W F TC=0+-100	24546	C3-1/8-T0-19R6-F	
A2R100	0698-7195	7	RESISTOR 19.6 1% .05W F TC=0+-100	24546	C3-1/8-T0-19R6-F	
A2R101	0698-8825	2	5	RESISTOR 681K 1% .125W F TC=0+-100	28480	0698-8825
A2R102	0699-0123	9		RESISTOR 6.75K .1% .125W F TC=0+-25	28480	0699-0123
A2R103	0698-8671	6		RESISTOR 273.2 .1% .125W F TC=0+-25	28480	0698-8671
A2R104	0698-7579	1		RESISTOR 7.853K .1% .125W F TC=0+-25	19701	MF4C1/8-T9-7853R-B
A2R105	0698-8009	4		RESISTOR 95 .1% .1W F TC=0+-15	07716	MAR5-1/10-T10-95R0-B
A2R106				NOT ASSIGNED		
A2R107				NOT ASSIGNED		
A2R108	0757-0470	3	2	RESISTOR 162K 1% .125W F TC=0+-100	24546	C4-1/8-T0-1623-F
A2R109	0698-7195	7		RESISTOR 19.6 1% .05W F TC=0+-100	24546	C3-1/8-T0-19R6-F
A2R110	0698-7195	7		RESISTOR 19.6 1% .05W F TC=0+-100	24546	C3-1/8-T0-19R6-F
A2R111	0698-7243	6	6	RESISTOR 1.96K 1% .05W F TC=0+-100	24546	C3-1/8-T0-1961-F
A2R112	0698-6261	6		RESISTOR 600 .25% .25W F TC=0+-50	28480	0698-6261
A2R113	0757-0727	3		RESISTOR 562 1% .25W F TC=0+-100	24546	C5-1/4-T0-562R-F
A2R114	0698-6362	8		RESISTOR 1K .1% .125W F TC=0+-25	28480	0698-6362
A2R115	0698-8803	6		RESISTOR 5.9K .1% .125W F TC=0+-25	28480	0698-8803
A2R116	0698-7220	9	9	RESISTOR 215 1% .05W F TC=0+-100	24546	C3-1/8-T0-215R-F
A2R117	0698-7220	9		RESISTOR 215 1% .05W F TC=0+-100	24546	C3-1/8-T0-215R-F
A2R118	0698-6360	6		RESISTOR 10K .1% .125W F TC=0+-25	28480	0698-6360
A2R119	0698-7249	2		RESISTOR 3.48K 1% .05W F TC=0+-100	24546	C3-1/8-T0-3481-F
A2R120	0698-6360	6		RESISTOR 10K .1% .125W F TC=0+-25	28480	0698-6360
A2R121	0698-7195	7	7	RESISTOR 19.6 1% .05W F TC=0+-100	24546	C3-1/8-T0-19R6-F
A2R122	0698-7195	7		RESISTOR 19.6 1% .05W F TC=0+-100	24546	C3-1/8-T0-19R6-F
A2R123	0698-7195	7		RESISTOR 19.6 1% .05W F TC=0+-100	24546	C3-1/8-T0-19R6-F
A2R124	0698-7195	7		RESISTOR 19.6 1% .05W F TC=0+-100	24546	C3-1/8-T0-19R6-F
A2R125-R130				NOT ASSIGNED		
A2R131	0698-6343	5	5	RESISTOR 9K .1% .125W F TC=0+-25	28480	0698-6343
A2R132	0698-6360	6		RESISTOR 10K .1% .125W F TC=0+-25	28480	0698-6360
A2R133	0698-6944	2		RESISTOR 35K 1% .125W F TC=0+-25	28480	0698-6944
A2R134	0698-7150	4		RESISTOR 306K .1% .125W F TC=0+-25	28480	0698-7150
A2R135	0698-8574	8		RESISTOR 2.429K .1% .125W F TC=0+-25	28480	0698-8574
A2R136	0698-7195	7	7	RESISTOR 19.6 1% .05W F TC=0+-100	24546	C3-1/8-T0-19R6-F
A2R137	0698-7195	7		RESISTOR 19.6 1% .05W F TC=0+-100	24546	C3-1/8-T0-19R6-F
A2R138	0698-7579	1		RESISTOR 7.853K .1% .125W F TC=0+-25	19701	MF4C1/8-T9-7853R-B
A2R139	0698-7195	7		RESISTOR 19.6 1% .05W F TC=0+-100	24546	C3-1/8-T0-19R6-F
A2R140	0698-7245	8		RESISTOR 2.37K 1% .05W F TC=0+-100	24546	C3-1/8-T0-2371-F
A2R141	0698-7195	7	7	RESISTOR 19.6 1% .05W F TC=0+-100	24546	C3-1/8-T0-19R6-F
A2R142	0698-7195	7		RESISTOR 19.6 1% .05W F TC=0+-100	24546	C3-1/8-T0-19R6-F
A2R143	0698-6360	6		RESISTOR 10K .1% .125W F TC=0+-25	28480	0698-6360
A2R144	0698-7248	1		RESISTOR 3.16K 1% .05W F TC=0+-100	24546	C3-1/8-T0-3161-F
A2R145	0698-6364	0		RESISTOR 50 .1% .125W F TC=0+-100	28480	0698-6364
A2R146	0698-7188	8	15	RESISTOR 10 1% .05W F TC=0+-100	24546	C3-1/8-T0-10R-F
A2R147	0698-7188	8		RESISTOR 10 1% .05W F TC=0+-100	24546	C3-1/8-T0-10R-F
A2R148	0698-6360	6		RESISTOR 10K .1% .125W F TC=0+-25	28480	0698-6360
A2R149	0698-6364	0		RESISTOR 50 .1% .125W F TC=0+-100	28480	0698-6364
A2R150	0698-6364	0		RESISTOR 50 .1% .125W F TC=0+-25	28480	0698-6364
A2R151	0699-0626	7	1	RESISTOR 3.056K .1% .125W F TC=0+-25	28480	0699-0626
A2R152	0698-6364	0		RESISTOR 50 .1% .125W F TC=0+-25	28480	0698-6364
A2R153	0699-0274	1		RESISTOR 350 .1% .125W F TC=0+-25	28480	0699-0274
A2R154	0699-0430	1		RESISTOR 54.47 .1% .125W F TC=0+-25	28480	0699-0430
A2R155	0698-6354	8		RESISTOR 40 .1% .125W F TC=0+-25	28480	0698-6354

See introduction to this section for ordering information.

\* Indicates factory selected value

Table 6-2. Replaceable Parts

Reference Designation	HP Part Number	C D	Qty	Description	Mfr Code	Mfr Part Number
A2R96	0698-3453	2		RESISTOR 196K 1% .125W F TC=0+-100	24546	C4-1/8-T0-1963-F
A2R97				NOT ASSIGNED		
A2R98				NOT ASSIGNED		
A2R99	0698-7195	7		RESISTOR 19.6 1% .05W F TC=0+-100	24546	C3-1/8-T0-19R6-F
A2R100	0698-7195	7		RESISTOR 19.6 1% .05W F TC=0+-100	24546	C3-1/8-T0-19R6-F
A2R101	0698-8825	2	5	RESISTOR 681K 1% .125W F TC=0+-100	28480	0698-8825
A2R102	0699-0123	9	1	RESISTOR 6.75K .1% .125W F TC=0+-25	28480	0699-0123
A2R103	0698-8671	6	1	RESISTOR 273.2 .1% .125W F TC=0+-25	28480	0698-8671
A2R104	0698-7579	1		RESISTOR 7.853K .1% .125W F TC=0+-25	19701	MF4C1/8-T9-7853R-B
A2R105	0698-8009	4	1	RESISTOR 95 .1% .1W F TC=0+-15	07716	MAR5-1/10-T10-95R0-B
A2R106				NOT ASSIGNED		
A2R107				NOT ASSIGNED		
A2R108	0757-0470	3	2	RESISTOR 162K 1% .125W F TC=0+-100	24546	C4-1/8-T0-1623-F
A2R109	0698-7195	7		RESISTOR 19.6 1% .05W F TC=0+-100	24546	C3-1/8-T0-19R6-F
A2R110	0698-7195	7		RESISTOR 19.6 1% .05W F TC=0+-100	24546	C3-1/8-T0-19R6-F
A2R111	0698-7243	6		RESISTOR 1.96K 1% .05W F TC=0+-100	24546	C3-1/8-T0-1961-F
A2R112	0698-6261	6		RESISTOR 600 .25% .25W F TC=0+-50	28480	0698-6261
A2R113	0757-0727	3		RESISTOR 562 1% .25W F TC=0+-100	24546	C5-1/4-T0-562R-F
A2R114	0698-6362	6		RESISTOR 1K .1% .125W F TC=0+-25	28480	0698-6362
A2R115	0698-8803	8		RESISTOR 5.9K .1% .125W F TC=0+-25	28480	0698-8803
A2R116	0698-7220	9		RESISTOR 215 1% .05W F TC=0+-100	24546	C3-1/8-T0-215R-F
A2R117	0698-7220	9		RESISTOR 215 1% .05W F TC=0+-100	24546	C3-1/8-T0-215R-F
A2R118	0698-6360	6		RESISTOR 10K .1% .125W F TC=0+-25	28480	0698-6360
A2R119	0698-7249	2		RESISTOR 3.48K 1% .05W F TC=0+-100	24546	C3-1/8-T0-3481-F
A2R120	0698-6360	6		RESISTOR 10K .1% .125W F TC=0+-25	28480	0698-6360
A2R121	0698-7195	7		RESISTOR 19.6 1% .05W F TC=0+-100	24546	C3-1/8-T0-19R6-F
A2R122	0698-7195	7		RESISTOR 19.6 1% .05W F TC=0+-100	24546	C3-1/8-T0-19R6-F
<b>2427A TO 2514A</b>						
A2R123	0698-7195	7		RESISTOR 19.6 1% .05W F TC=0+-100	24546	C3-1/8-T0-19R6-F
A2R124	0698-7195	7		RESISTOR 19.6 1% .05W F TC=0+-100	24546	C3-1/8-T0-19R6-F
<b>2714A AND ABOVE</b>						
A2R123				NOT ASSIGNED		
A2R124				NOT ASSIGNED		
A2R125-R130				NOT ASSIGNED		
A2R131	0698-6343	5		RESISTOR 9K .1% .125W F TC=0+-25	28480	0698-6343
A2R132	0698-6360	6		RESISTOR 10K .1% .125W F TC=0+-25	28480	0698-6360
A2R133	0698-6944	2	1	RESISTOR 35K 1% .125W F TC=0+-25	28480	0698-6944
A2R134	0698-7150	4	1	RESISTOR 306K .1% .125W F TC=0+-25	28480	0698-7150
A2R135	0698-8574	8	1	RESISTOR 2.429K .1% .125W F TC=0+-25	28480	0698-8574
A2R136	0698-7195	7		RESISTOR 19.6 1% .05W F TC=0+-100	24546	C3-1/8-T0-19R6-F
A2R137	0698-7195	7		RESISTOR 19.6 1% .05W F TC=0+-100	24546	C3-1/8-T0-19R6-F
A2R138	0698-7579	1		RESISTOR 7.853K .1% .125W F TC=0+-25	19701	MF4C1/8-T9-7853R-B
A2R139	0698-7195	7		RESISTOR 19.6 1% .05W F TC=0+-100	24546	C3-1/8-T0-19R6-F
A2R140	0698-7245	8		RESISTOR 2.37K 1% .05W F TC=0+-100	24546	C3-1/8-T0-2371-F
A2R141	0698-7195	7		RESISTOR 19.6 1% .05W F TC=0+-100	24546	C3-1/8-T0-19R6-F
A2R142	0698-7195	7		RESISTOR 19.6 1% .05W F TC=0+-100	24546	C3-1/8-T0-19R6-F
A2R143	0698-6360	6		RESISTOR 10K .1% .125W F TC=0+-25	28480	0698-6360
A2R144	0698-7248	1		RESISTOR 3.16K 1% .05W F TC=0+-100	24546	C3-1/8-T0-3161-F
A2R145	0698-6364	0		RESISTOR 50 .1% .125W F TC=0+-100	28480	0698-6364
A2R146	0698-7188	8	15	RESISTOR 10 1% .05W F TC=0+-100	24546	C3-1/8-T0-10R-F
A2R147	0698-7188	8		RESISTOR 10 1% .05W F TC=0+-100	24546	C3-1/8-T0-10R-F
A2R148	0698-6360	6		RESISTOR 10K .1% .125W F TC=0+-25	28480	0698-6360
A2R149	0698-6364	0		RESISTOR 50 .1% .125W F TC=0+-100	28480	0698-6364
A2R150	0698-6364	0	4	RESISTOR 50 .1% .125W F TC=0+-25	28480	0698-6364
A2R151	0699-0626	7	1	RESISTOR 3.056K .1% .125W F TC=0+-25	28480	0699-0626
A2R152	0698-6364	0		RESISTOR 50 .1% .125W F TC=0+-25	28480	0698-6364
A2R153	0699-0274	1	1	RESISTOR 350 .1% .125W F TC=0+-25	28480	0699-0274
A2R154	0699-0430	1	1	RESISTOR 54.47 .1% .125W F TC=0+-25	28480	0699-0430
A2R155	0698-6354	8	1	RESISTOR 40 .1% .125W F TC=0+-25	28480	0698-6354
A2R156	0698-6364	0		RESISTOR 50 .1% .125W F TC=0+-25	28480	0698-6364
A2R157	0698-7574	6	1	RESISTOR 31.62 .1% .125W F TC=0+-25	19701	MF4C1/8-T9-31R62-B
A2R158	0698-7093	4	1	RESISTOR 46.5 .1% .125W F TC=0+-25	28480	0698-7093
A2R159	0698-7260	7		RESISTOR 10K 1% .05W F TC=0+-100	24546	C3-1/8-T0-1002-F
A2R160	0698-7260	7		RESISTOR 10K 1% .05W F TC=0+-100	24546	C3-1/8-T0-1002-F

See introduction to this section for ordering information.

\* Indicates factory selected value

Table 6-2. Replaceable Parts

Reference Designation	HP Part Number	C D	Qty	Description	Mfr Code	Mfr Part Number
A2R161 A2R162 A2R163 A2R164 A2R165	0698-7260	7		NOT ASSIGNED NOT ASSIGNED RESISTOR 10K 1% .05W F TC=0+-100 NOT ASSIGNED NOT ASSIGNED	24546	C3-1/8-T0-1002-F
A2R166 A2R167 A2R168 A2R169 A2R170	0698-7260	7		RESISTOR 10K 1% .05W F TC=0+-100 NOT ASSIGNED NOT ASSIGNED RESISTOR 10K 1% .05W F TC=0+-100 NOT ASSIGNED	24546	C3-1/8-T0-1002-F
A2R171 A2R172 A2R173 A2R174 A2R175	0698-7260	7		NOT ASSIGNED RESISTOR 10K 1% .05W F TC=0+-100 NOT ASSIGNED NOT ASSIGNED RESISTOR 10K 1% .05W F TC=0+-100	24546	C3-1/8-T0-1002-F
A2R176 A2R177 A2R178 A2R179 A2R180	0698-7236 0698-6362 0698-6362	7 8 8		NOT ASSIGNED NOT ASSIGNED RESISTOR 1K 1% .05W F TC=0+-100 RESISTOR 1K .1% .125W F TC=0+-25 RESISTOR 1K .1% .125W F TC=0+-25	24546 28480 28480	C3-1/8-T0-1001-F 0698-6362 0698-6362
A2R181 A2R182 A2R183 A2R184 A2R185 A2R186	0698-7225 0698-7236  0698-7242 0698-7242 0698-7253	4 7  5 5 8	1	RESISTOR 348 1% .05W F TC=0+-100 RESISTOR 1K 1% .05W F TC=0+-100 NOT ASSIGNED RESISTOR 1.78K 1% .05W F TC=0+-100 RESISTOR 1.78K 1% .05W F TC=0+-100 RESISTOR 5.11K 1% .05W F TC=0+-100	24546 24546  24546 24546 24546	C3-1/8-T0-348R-F C3-1/8-T0-1001-F  C3-1/8-T0-1781-F C3-1/8-T0-1781-F C3-1/8-T0-5111-F
A2R187 A2R188	0698-7253 0698-7195	8 7		RESISTOR 5.11K 1% .05W F TC=0+-100 RESISTOR 19.6 1% .05W F TC=0+-100	24546 24546	C3-1/8-T0-5111-F C3-1/8-T0-19R6-F
2427A TO 2513A A2R189 A2R190 2514A AND ABOVE A2R189 A2R190	0699-0073 0698-7248	8 1		NOT ASSIGNED NOT ASSIGNED RESISTOR 10M 1% .125W F TC=0+-150 RESISTOR 3.16K 1% .05W F TC=0+-100	28480 28480	0699-0073 0698-7248
2427A TO 2514A A2R191-199 2714A TO 2726A A2R191 A2R192 A2R193 A2R194 A2R195 A2R196 A2R197 A2R198 A2R199	0698-7253 0698-7253 0698-7253 0698-7253 0698-7253 0698-7253 0698-7253 0698-7253 0698-7253 0698-7253	8 8 8 8 8 8 8 8 8 8		NOT ASSIGNED RESISTOR 5.11K 1% .05W F TC=+-100 RESISTOR 5.11K 1% .05W F TC=+-100 RESISTOR 5.11K 1% .05W F TC=+-100 RESISTOR 5.11K 1% .05W F TC=+-100 RESISTOR 5.11K 1% .05W F TC=+-100 RESISTOR 5.11K 1% .05W F TC=+-100 RESISTOR 5.11K 1% .05W F TC=+-100 RESISTOR 5.11K 1% .05W F TC=+-100 RESISTOR 5.11K 1% .05W F TC=+-100 RESISTOR 5.11K 1% .05W F TC=+-100	24546 24546 24546 24546 24546 24546 24546 24546 24546 24546	C3-1/8-T0-4641-F C3-1/8-T0-4641-F C3-1/8-T0-4641-F C3-1/8-T0-4641-F C3-1/8-T0-4641-F C3-1/8-T0-4641-F C3-1/8-T0-4641-F C3-1/8-T0-4641-F C3-1/8-T0-4641-F C3-1/8-T0-4641-F
2727A AND ABOVE A2R191 A2R192 A2R193 A2R194 A2R195 A2R196 A2R197 A2R198 A2R199	8159-0005 8159-0005 8159-0005 8159-0005 8159-0005 8159-0005 8159-0005 8159-0005 8159-0005	0 0 0 0 0 0 0 0 0		RESISTOR-ZERO OHMS 22 AWG LEAD DIA RESISTOR-ZERO OHMS 22 AWG LEAD DIA RESISTOR-ZERO OHMS 22 AWG LEAD DIA RESISTOR-ZERO OHMS 22 AWG LEAD DIA RESISTOR-ZERO OHMS 22 AWG LEAD DIA RESISTOR-ZERO OHMS 22 AWG LEAD DIA RESISTOR-ZERO OHMS 22 AWG LEAD DIA RESISTOR-ZERO OHMS 22 AWG LEAD DIA RESISTOR-ZERO OHMS 22 AWG LEAD DIA	28480 28480 28480 28480 28480 28480 28480 28480 28480	8159-0005-4641-F 8159-0005-4641-F 8159-0005-4641-F 8159-0005-4641-F 8159-0005-4641-F 8159-0005-4641-F 8159-0005-4641-F 8159-0005-4641-F 8159-0005-4641-F
A2TP1-TP30	0360-0535	0		TERMINAL TEST POINT PCB	00000	ORDER BY DESCRIPTION
2427A TO 2514A A2U1 A2U2 2714A AND ABOVE A2U1 A2U2 A2U3 2427A TO 2514A A2U4 2714A AND ABOVE A2U4	1826-1596 1826-1596  1826-0982 1826-1596	4 4  0 4	11   13	ANALOG SWITCH DPDT 14 -CBRZ/SDR ANALOG SWITCH DPDT 14 -CBRZ/SDR  IC OP AMP LOW-NOISE 8-DIP-C PKG ANALOG SWITCH DPDT 14 -CBRZ/SDR  NOT ASSIGNED	28480 28480  28480 28480	1826-1596 1826-1596  1826-0982 1826-1596

See introduction to this section for ordering information.

\* Indicates factory selected value

Table 6-2. Replaceable Parts

Reference Designation	HP Part Number	C D	Qty	Description	Mfr Code	Mfr Part Number
A2U31	1820-1858	9	6	IC FF TTL LS D-TYPE OCTL	01295	SN74LS377N
A2U32	1820-3100	8		IC CDCR TTL ALS BIN 3-TO-8-LINE 3-INP	28480	1820-3100
A2U33	1826-0921	7		D/A 10-BIT 16-CBRZ/SDR CMOS	28480	1826-0921
A2U34	1826-0982	0		IC OP AMP LOW-NOISE 8-DIP-C PKG	28480	1826-0982
A2U35	1826-0606	5		IC SWITCH ANLG QUAD 16-DIP-C PKG	17856	DG201BK
A2U36	1826-1513	5	2	IC OP AMP LOW-BIAS-H-IMPD DUAL 8-DIP-C	04713	1826-1513
A2U37	1826-0606	5		IC SWITCH ANLG QUAD 16-DIP-C PKG	17856	DG201BK
A2U38	1826-1513	5	2	IC OP AMP LOW-BIAS-H-IMPD DUAL 8-DIP-C	04713	1826-1513
A2U39	1820-1440	5		IC LCH TTL LS QUAD	01295	SN74LS279N
A2U40	1820-2739	7	1	IC GATE TTL ALS NOR QUAD 2-INP	01295	SN74ALS02N
A2U41	1820-1858	9	9	IC FF TTL LS D-TYPE OCTL	01295	SN74LS377N
A2U42	1820-1858	9		IC FF TTL LS D-TYPE OCTL	01295	SN74LS377N
A2U43	1826-0921	7		D/A 10-BIT 16-CBRZ/SDR CMOS	28480	1826-0921
A2U44	1826-0982	0		IC OP AMP LOW-NOISE 8-DIP-C PKG	28480	1826-0982
A2U45	1826-0606	5		IC SWITCH ANLG QUAD 16-DIP-C PKG	17856	DG201BK
A2U46	1820-1858	9	2	IC FF TTL LS D-TYPE OCTL	01295	SN74LS377N
A2U47	1826-0921	7		D/A 10-BIT 16-CBRZ/SDR CMOS	28480	1826-0921
A2U48	1826-0982	0		IC OP AMP LOW-NOISE 8-DIP-C PKG	28480	1826-0982
A2U49	1826-0982	0		IC OP AMP LOW-NOISE 8-DIP-C PKG	28480	1826-0982
A2U50	1826-0210	7		IC COMPARATOR HS 14-DIP-P PKG	27014	LM361N
A2U51	1826-0606	5	8	IC SWITCH ANLG QUAD 16-DIP-C PKG	17856	DG201BK
A2U52	1826-0606	4		IC MULTIPLXR 8-CHAN-ANLG 16-DIP-C PKG	17856	DG508BK
A2U53	1826-0014	9		IC MULTIPLIER 14-DIP-C PKG	04713	MC1595L
A2U54	1826-0982	0		IC OP AMP LOW-NOISE 8-DIP-C PKG	28480	1826-0982
A2VR1	1902-0943	5	4	DIODE-ZNR 2.4V 5% D0-35 PD=.4W TC=-.037%	28480	1902-0943
A2VR2	1902-0957	1		DIODE-ZNR 9.1V 5% D0-35 PD=.4W TC=+.069%	28480	1902-0957
A2VR3	1902-0957	1		DIODE-ZNR 9.1V 5% D0-35 PD=.4W TC=+.069%	28480	1902-0957
A2VR4	1902-0957	1		DIODE-ZNR 9.1V 5% D0-35 PD=.4W TC=+.069%	28480	1902-0957
A2VR5	1902-0957	1		DIODE-ZNR 9.1V 5% D0-35 PD=.4W TC=+.069%	28480	1902-0957
A2VR6	1902-0956	0	4	DIODE-ZNR 8.2V 5% D0-35 PD=.4W TC=+.065%	28480	1902-0956
A2VR7	1902-0956	0		DIODE-ZNR 8.2V 5% D0-35 PD=.4W TC=+.065%	28480	1902-0956
A2VR8	1902-0956	0		DIODE-ZNR 8.2V 5% D0-35 PD=.4W TC=+.065%	28480	1902-0956
A2VR9	1902-0956	0		DIODE-ZNR 8.2V 5% D0-35 PD=.4W TC=+.065%	28480	1902-0956

See introduction to this section for ordering information.

\* Indicates factory selected value





Table 6-2. Replaceable Parts

Reference Designation	HP Part Number	C D	Qty	Description	Mfr Code	Mfr Part Number
<b>A3</b>						
A3	08642-60891	1	1	PROCESSOR/MEMORY MODULE	28480	08642-60891
A3	08642-69891	9	1	PROCESSOR/MEMORY MODULE (RESTORED)	28480	08642-69891
<i>A3BT1</i>	1420-0351	7	1	BATTERY 3.6V .045A-HR NI-CD W-FLEX	28480	1420-0351
A3C1	0180-0228	6	2	CAPACITOR-FXD 22UF+-10% 15VDC TA	56289	150D226X9015B2
A3C2	0160-4835	7		CAPACITOR-FXD .1UF +-10% 50VDC CER	28480	0160-4835
A3C3				NOT ASSIGNED		
A3C4	0160-4835	7		CAPACITOR-FXD .1UF +-10% 50VDC CER	28480	0160-4835
A3C5	0160-4835	7		CAPACITOR-FXD .1UF +-10% 50VDC CER	28480	0160-4835
A3C6	0160-4835	7		CAPACITOR-FXD .1UF +-10% 50VDC CER	28480	0160-4835
A3C7	0160-4835	7		CAPACITOR-FXD .1UF +-10% 50VDC CER	28480	0160-4835
A3C8	0160-3531	8	3	CAPACITOR-FXD 2UF +-5% 50VDC MET-POLYC	28480	0160-3531
A3C9	0160-4835	7		CAPACITOR-FXD .1UF +-10% 50VDC CER	28480	0160-4835
A3C10	0160-4835	7		CAPACITOR-FXD .1UF +-10% 50VDC CER	28480	0160-4835
A3C11	0160-4835	7		CAPACITOR-FXD .1UF +-10% 50VDC CER	28480	0160-4835
A3C12	0180-0100	3	8	CAPACITOR-FXD 4.7UF+-10% 35VDC TA	56289	150D475X9035B2
A3C13	0160-4835	7		CAPACITOR-FXD .1UF +-10% 50VDC CER	28480	0160-4835
A3C14	0180-0100	3		CAPACITOR-FXD 4.7UF+-10% 35VDC TA	56289	150D475X9035B2
A3C15				NOT ASSIGNED		
A3C16	0160-4835	7		CAPACITOR-FXD .1UF +-10% 50VDC CER	28480	0160-4835
A3C17	0160-4835	7		CAPACITOR-FXD .1UF +-10% 50VDC CER	28480	0160-4835
A3C18	0160-4835	7		CAPACITOR-FXD .1UF +-10% 50VDC CER	28480	0160-4835
A3C19	0160-4835	7		CAPACITOR-FXD .1UF +-10% 50VDC CER	28480	0160-4835
A3C20	0160-4835	7		CAPACITOR-FXD .1UF +-10% 50VDC CER	28480	0160-4835
A3C21	0160-4835	7		CAPACITOR-FXD .1UF +-10% 50VDC CER	28480	0160-4835
A3C22	0160-4835	7		CAPACITOR-FXD .1UF +-10% 50VDC CER	28480	0160-4835
A3C23	0160-4835	7		CAPACITOR-FXD .1UF +-10% 50VDC CER	28480	0160-4835
A3C24	0160-4835	7		CAPACITOR-FXD .1UF +-10% 50VDC CER	28480	0160-4835
A3C25	0160-4835	7		CAPACITOR-FXD .1UF +-10% 50VDC CER	28480	0160-4835
A3C26	0180-0100	3		CAPACITOR-FXD 4.7UF+-10% 35VDC TA	56289	150D475X9035B2
A3C27	0160-4835	7		CAPACITOR-FXD .1UF +-10% 50VDC CER	28480	0160-4835
A3C28	0160-4835	7		CAPACITOR-FXD .1UF +-10% 50VDC CER	28480	0160-4835
A3C29	0160-4835	7		CAPACITOR-FXD .1UF +-10% 50VDC CER	28480	0160-4835
A3C30	0160-4835	7		CAPACITOR-FXD .1UF +-10% 50VDC CER	28480	0160-4835
A3C31	0160-4835	7		CAPACITOR-FXD .1UF +-10% 50VDC CER	28480	0160-4835
A3C32	0160-4835	7		CAPACITOR-FXD .1UF +-10% 50VDC CER	28480	0160-4835
A3C33				NOT ASSIGNED		
A3C34	0160-4835	7		CAPACITOR-FXD .1UF +-10% 50VDC CER	28480	0160-4835
A3C35				NOT ASSIGNED		
A3C36	0180-0100	3		CAPACITOR-FXD 4.7UF+-10% 35VDC TA	56289	150D475X9035B2
A3C37	0160-4832	4		CAPACITOR-FXD .01UF +-10% 100VDC CER	28480	0160-4832
A3C38	0180-0374	3	1	CAPACITOR-FXD 10UF+-10% 20VDC TA	56289	150D106X9020B2
A3C39	0160-4835	7		CAPACITOR-FXD .1UF +-10% 50VDC CER	28480	0160-4835
A3C40	0160-4835	7		CAPACITOR-FXD .1UF +-10% 50VDC CER	28480	0160-4835
A3C41	0160-4835	7		CAPACITOR-FXD .1UF +-10% 50VDC CER	28480	0160-4835
A3C42	0160-4835	7		CAPACITOR-FXD .1UF +-10% 50VDC CER	28480	0160-4835
A3C43	0160-4835	7		CAPACITOR-FXD .1UF +-10% 50VDC CER	28480	0160-4835
A3C44	0180-0100	3		CAPACITOR-FXD 4.7UF+-10% 35VDC TA	56289	150D475X9035B2
A3CR1				NOT ASSIGNED		
A3CR2	1901-1128	8		DIODE-SCHOTTKY 40V 1A	28480	1901-1128
A3CR3	1901-0050	3		DIODE-SWITCHING 80V 200MA 2NS DO-35	28480	1901-0050
A3CR4				NOT ASSIGNED		
A3CR5	1902-0945	7	1	DIODE-ZNR 3V 5% DO-35 PD=.4W TC=-.043%	28480	1902-0945
A3CR6				NOT ASSIGNED		
A3CR7	1901-0050	3		DIODE-SWITCHING 80V 200MA 2NS DO-35	28480	1901-0050
A3CR8	1901-0050	3		DIODE-SWITCHING 80V 200MA 2NS DO-35	28480	1901-0050
A3CR9	1901-1128	8		DIODE-SCHOTTKY 40V 1A	28480	1901-1128
A3J1	1252-0074	4	1	CONN POST TYPE .100-PIN-SPCG 36-CONT	28480	1252-0074
A3J2	1251-5039	9	1	CONNECTOR 18-PIN M POST TYPE	22526	65500-118
A3J3	1251-7307	8	7	CONN POST TYPE .100-PIN-SPCG 50-CONT	28480	1251-7307
A3J4	1252-0046	0	1	CONN POST TYPE .100-PIN-SPCG 18-CONT	28480	1252-0046

See introduction to this section for ordering information.

\* Indicates factory selected value

Table 6-2. Replaceable Parts

Reference Designation	HP Part Number	C D	Qty	Description	Mfr Code	Mfr Part Number
A3L1	9100-1788	6	4	CORE-FERRITE CHOKE-WIDEBAND; IMP:>680	28480	9100-1788
A3MP1	1400-0249	0		CABLE TIE .062-.625-DIA .091-WD NYL	06383	PLT1M-8
A3MP2	5040-6068	3	2	EXTR PC BD BLK	28480	5040-6068
	1480-0073	6	4	PIN-ROLL .062-IN-DIA .25-IN-LG BE-CU	28480	1480-0073
A3MP3	5040-6067	2	2	EXTR PC BD WHT	28480	5040-6067
	1480-0073	6	2	PIN-ROLL .062-IN-DIA .25-IN-LG BE-CU	28480	1480-0073
A3MP4	08642-40032	0	6	SPACER	28480	08642-40032
A3P1-P4				NOT ASSIGNED		
A3P5	1251-7307	8		CONN POST TYPE .100-PIN-SPCG 50-CONT	28480	1251-7307
A3P6				NOT ASSIGNED		
A3P7				NOT ASSIGNED		
A3P8	1251-7307	8		CONN POST TYPE .100-PIN-SPCG 50-CONT	28480	1251-7307
A3Q1				NOT ASSIGNED		
A3Q2	1853-0459	3	20	TRANSISTOR PNP SI PD=625MW FT=200MHZ	28480	1853-0459
A3Q3-Q8				NOT ASSIGNED		
A3Q9	1854-0809	9	2	TRANSISTOR NPN 2N2369A SI TO-18 PD=360MW	28480	1854-0809
A3R1	0757-0280	3		RESISTOR 1K 1% .125W F TC=0+-100	24546	C4-1/8-T0-1001-F
A3R2	0757-0442	9		RESISTOR 10K 1% .125W F TC=0+-100	24546	C4-1/8-T0-1002-F
A3R3	0757-0280	3		RESISTOR 1K 1% .125W F TC=0+-100	24546	C4-1/8-T0-1001-F
A3R4	0699-0150	2	2	RESISTOR 16.2K .1% .1W F TC=0+-15	28480	0699-0150
A3R5	0699-0150	2		RESISTOR 16.2K .1% .1W F TC=0+-15	28480	0699-0150
A3R6	0757-0280	3		RESISTOR 1K 1% .125W F TC=0+-100	24546	C4-1/8-T0-1001-F
A3R7	0698-8960	6	1	RESISTOR 750K 1% .125W F TC=0+-100	28480	0698-8960
A3R8-R11				NOT ASSIGNED		
A3R12	0757-0280	3		RESISTOR 1K 1% .125W F TC=0+-100	24546	C4-1/8-T0-1001-F
A3R13	0757-0442	9		RESISTOR 10K 1% .125W F TC=0+-100	24546	C4-1/8-T0-1002-F
A3R14-R23				NOT ASSIGNED		
A3R24	0698-3445	2	3	RESISTOR 348 1% .125W F TC=0+-100	24546	C4-1/8-T0-348R-F
A3R25				NOT ASSIGNED		
A3R26	0757-0438	3	8	RESISTOR 5.11K 1% .125W F TC=0+-100	24546	C4-1/8-T0-5111-F
A3R27-R29				NOT ASSIGNED		
A3R30	0698-3441	8	7	RESISTOR 215 1% .125W F TC=0+-100	24546	C4-1/8-T0-215R-F
A3R31	0698-3437	2	1	RESISTOR 133 1% .125W F TC=0+-100	24546	C4-1/8-T0-133R-F
A3R32	0757-0439	4	1	RESISTOR 6.81K 1% .125W F TC=0+-100	24546	C4-1/8-T0-6811-F
A3R33	0757-0280	3		RESISTOR 1K 1% .125W F TC=0+-100	24546	C4-1/8-T0-1001-F
A3R34	0698-8827	4	8	RESISTOR 1M 1% .125W F TC=0+-100	28480	0698-8827
A3R35	0757-0465	6		RESISTOR 100K 1% .125W F TC=0+-100	24546	C4-1/8-T0-1003-F
A3R36	0757-0465	6		RESISTOR 100K 1% .125W F TC=0+-100	24546	C4-1/8-T0-1003-F
A3R37	0698-3450	9	2	RESISTOR 42.2K 1% .125W F TC=0+-100	24546	C4-1/8-T0-4222-F
A3R38	0698-3452	1	3	RESISTOR 147K 1% .125W F TC=0+-100	24546	C4-1/8-T0-1473-F
A3R39	0698-3155	1	3	RESISTOR 4.64K 1% .125W F TC=0+-100	24546	C4-1/8-T0-4641-F
A3R40	0757-0442	9		RESISTOR 10K 1% .125W F TC=0+-100	24546	C4-1/8-T0-1002-F
A3R41-R43				NOT ASSIGNED		
A3R44	0698-0084	9	12	RESISTOR 2.15K 1% .125W F TC=0+-100	24546	C4-1/8-T0-2151-F
A3R45	0698-3440	7	4	RESISTOR 196 1% .125W F TC=0+-100	24546	C4-1/8-T0-196R-F
A3R46	0757-0442	9		RESISTOR 10K 1% .125W F TC=0+-100	24546	C4-1/8-T0-1002-F
A3R47	0757-0280	3		RESISTOR 1K 1% .125W F TC=0+-100	24546	C4-1/8-T0-1001-F
A3R48	0757-0442	9		RESISTOR 10K 1% .125W F TC=0+-100	24546	C4-1/8-T0-1002-F
A3R49	2100-3759	8	1	RESISTOR-TRMR 2K 10% C SIDE-ADJ 17-TRN	28480	2100-3759
A3R50	0757-0442	9		RESISTOR 10K 1% .125W F TC=0+-100	24546	C4-1/8-T0-1002-F
A3R51	0757-0280	3		RESISTOR 1K 1% .125W F TC=0+-100	24546	C4-1/8-T0-1001-F
2427A TO 2612A A3R52 2613A AND ABOVE A3R52	0698-3433	8	1	RESISTOR 28.7 1% .125W F TC=0+-100	03888	PME55-1/8-T0-2BR7
A3S1	3101-2482	5	1	SWITCH-RKR DIP-RKR-ASSY 3PDT .05A 30VDC	28480	3101-2482
A3S2	3101-2751	1	2	SWITCH-RKR DIP-RKR-ASSY 2-1A .015A 24VDC	28480	3101-2751
A3TP1	0360-0535	0		TERMINAL TEST POINT PCB	00000	ORDER BY DESCRIPTION
A3U1	1820-2657	8	3	IC GATE TTL ALS OR QUAD 2-INP	01295	SN74ALS32N
A3U2	1813-0203	1	1	XTAL-CLOCK OSCILLATOR 5-MHZ 0.01% TTL	28480	1813-0203
A3U3	1820-3466	9	1	IC FF TTL ALS D-TYPE POS-EDGE-TRIG COM	28480	1820-3466
A3U4	1820-3718	4	1	IC DRVR TTL ALS NOR HEX 2-INP	28480	1820-3718
A3U5	1820-2488	3	3	IC FF TTL ALS D-TYPE POS-EDGE-TRIG	01295	SN74ALS74N
A3U6	1820-2656	7	2	IC GATE TTL ALS NAND QUAD 2-INP	01295	SN74ALS00N
A3U7	1820-2657	8		IC GATE TTL ALS OR QUAD 2-INP	01295	SN74ALS32N
A3U8	1820-2488	3		IC FF TTL ALS D-TYPE POS-EDGE-TRIG	01295	SN74ALS74N
A3U9	1820-2634	1	2	IC INV TTL ALS HEX	01295	SN74ALS04N
A3U10	1820-2096	9	3	IC CNTR TTL LS BIN DUAL 4-BIT	01295	SN74LS393N

See introduction to this section for ordering information.

\* Indicates factory selected value

Table 6-2. Replaceable Parts

Reference Designation	HP Part Number	C D	Qty	Description	Mfr Code	Mfr Part Number
A3U11	1820-3318	0	1	IC FF TTL ALS D-TYPE POS-EDGE-TRIG COM	28480	1820-3318
A3U12	1820-2505	5	1	IC-MPU;CLK FREQ=8MHZ, INSTRUCTION	28480	1820-2505
A3U13	1826-1201	8	1	IC V RGLTR-FXD-POS 4.5/5.5V TO-220 PKG	28480	1826-1201
	0515-0655	4	23	SCREW-MACH M3 X 0.5 8MM-LG PAN-HD	00000	ORDER BY DESCRIPTION
	0535-0004	9	17	NUT-HEX DBL-CHAM M3 X 0.5 2.4MM-THK	00000	ORDER BY DESCRIPTION
	2190-0584	0	27	WASHER-LK HLCL 3.0 MM 3.1-MM-ID	28480	2190-0584
A3U14	1826-0773	7	1	IC OP AMP GP TO-99 PKG	27014	LM10CH
A3U15	1820-3100	8		IC DCDR TTL ALS BIN 3-TO-8-LINE 3-INP	28480	1820-3100
A3U16	1820-1851	2	1	IC ENCDR TTL LS	01295	SN74LS148N
A3U17	1820-3100	8		IC DCDR TTL ALS BIN 3-TO-8-LINE 3-INP	28480	1820-3100
A3U18				NOT ASSIGNED		
A3U19	1820-3100	8		IC DCDR TTL ALS BIN 3-TO-8-LINE 3-INP	28480	1820-3100
A3U20	1818-3375	4	4	IC NMOS 16384 (16K) EAROM 450-NS 3-S	28480	1818-3375
A3U21	1818-3375	4		IC NMOS 16384 (16K) EAROM 450-NS 3-S	28480	1818-3375
A3U22				NOT ASSIGNED		
<b>2427A TO 2514A</b>						
A3U23	08642-80138	1	1	PROM-PROGRAMMED	28480	08642-80138
A3U24	08642-80139	2	1	PROM-PROGRAMMED	28480	08642-80139
A3U25	08642-80140	5	1	PROM-PROGRAMMED	28480	08642-80140
A3U26	08642-80141	6	1	PROM-PROGRAMMED	28480	08642-80141
A3U27	08642-80142	7	1	PROM-PROGRAMMED	28480	08642-80142
A3U28	08642-80143	8	1	PROM-PROGRAMMED	28480	08642-80143
<b>2515A ONLY</b>						
A3U23	08642-80238	1	1	PROM-PROGRAMMED	28480	08642-80238
A3U24	08642-80239	2	1	PROM-PROGRAMMED	28480	08642-80239
A3U25	08642-80240	5	1	PROM-PROGRAMMED	28480	08642-80240
A3U26	08642-80241	7	1	PROM-PROGRAMMED	28480	08642-80241
A3U27	08642-80242	8	1	PROM-PROGRAMMED	28480	08642-80242
A3U28	08642-80243	9	1	PROM-PROGRAMMED	28480	08642-80243
<b>2516A TO 2521A</b>						
A3U23	08642-80438	4	1	PROM-PROGRAMMED	28480	08642-80438
A3U24	08642-80439	5	1	PROM-PROGRAMMED	28480	08642-80439
A3U25	08642-80440	8	1	PROM-PROGRAMMED	28480	08642-80440
A3U26	08642-80441	6	1	PROM-PROGRAMMED	28480	08642-80441
A3U27	08642-80442	0	1	PROM-PROGRAMMED	28480	08642-80442
A3U28	08642-80443	1	1	PROM-PROGRAMMED	28480	08642-80443
<b>2526A ONLY</b>						
A3U23	08642-80538	5	1	PROM-PROGRAMMED	28480	08642-80538
A3U24	08642-80539	6	1	PROM-PROGRAMMED	28480	08642-80539
A3U25	08642-80540	9	1	PROM-PROGRAMMED	28480	08642-80540
A3U26	08642-80541	0	1	PROM-PROGRAMMED	28480	08642-80541
A3U27	08642-80542	1	1	PROM-PROGRAMMED	28480	08642-80542
A3U28	08642-80543	2	1	PROM-PROGRAMMED	28480	08642-80543
<b>2527A TO 2530A</b>						
A3U23	08642-80638	6	1	PROM-PROGRAMMED	28480	08642-80638
A3U24	08642-80639	7	1	PROM-PROGRAMMED	28480	08642-80639
A3U25	08642-80640	0	1	PROM-PROGRAMMED	28480	08642-80640
A3U26	08642-80641	1	1	PROM-PROGRAMMED	28480	08642-80641
A3U27	08642-80642	2	1	PROM-PROGRAMMED	28480	08642-80642
A3U28	08642-80643	3	1	PROM-PROGRAMMED	28480	08642-80643
<b>2531A TO 2551A</b>						
A3U23	08642-80738	7	1	PROM-PROGRAMMED	28480	08642-80738
A3U24	08642-80739	8	1	PROM-PROGRAMMED	28480	08642-80739
A3U25	08642-80740	1	1	PROM-PROGRAMMED	28480	08642-80740
A3U26	08642-80741	2	1	PROM-PROGRAMMED	28480	08642-80741
A3U27	08642-80742	3	1	PROM-PROGRAMMED	28480	08642-80742
A3U28	08642-80743	4	1	PROM-PROGRAMMED	28480	08642-80743
<b>2601A TO 2615A</b>						
A3U23	08642-80838	8	1	PROM-PROGRAMMED	28480	08642-80838
A3U24	08642-80839	9	1	PROM-PROGRAMMED	28480	08642-80839
A3U25	08642-80840	2	1	PROM-PROGRAMMED	28480	08642-80840
A3U26	08642-80841	3	1	PROM-PROGRAMMED	28480	08642-80841
A3U27	08642-80842	4	1	PROM-PROGRAMMED	28480	08642-80842
A3U28	08642-80843	5	1	PROM-PROGRAMMED	28480	08642-80843

See introduction to this section for ordering information.

\* Indicates factory selected value

Table 6-2. Replaceable Parts

Reference Designation	HP Part Number	C D	Qty	Description	Mfr Code	Mfr Part Number
<b>2622A TO 2643A</b>						
A3U23	08642-80938	9	1	PROM-PROGRAMMED	28480	08642-80938
A3U24	08642-80939	0	1	PROM-PROGRAMMED	28480	08642-80939
A3U25	08642-80940	3	1	PROM-PROGRAMMED	28480	08642-80940
A3U26	08642-80941	4	1	PROM-PROGRAMMED	28480	08642-80941
A3U27	08642-80942	5	1	PROM-PROGRAMMED	28480	08642-80942
A3U28	08642-80943	6	1	PROM-PROGRAMMED	28480	08642-80943
<b>2644A TO 2647A</b>						
A3U23	08642-80188	1	1	PROM-PROGRAMMED	28480	08642-80188
A3U24	08642-80189	2	1	PROM-PROGRAMMED	28480	08642-80189
A3U25	08642-80190	5	1	PROM-PROGRAMMED	28480	08642-80190
A3U26	08642-80191	7	1	PROM-PROGRAMMED	28480	08642-80191
A3U27	08642-80192	7	1	PROM-PROGRAMMED	28480	08642-80192
A3U28	08642-80193	8	1	PROM-PROGRAMMED	28480	08642-80193
<b>2651A TO 2707A</b>						
A3U23	08642-80288	2	1	PROM-PROGRAMMED	28480	08642-80288
A3U24	08642-80289	3	1	PROM-PROGRAMMED	28480	08642-80289
A3U25	08642-80290	6	1	PROM-PROGRAMMED	28480	08642-80290
A3U26	08642-80291	7	1	PROM-PROGRAMMED	28480	08642-80291
A3U27	08642-80292	8	1	PROM-PROGRAMMED	28480	08642-80292
A3U28	08642-80293	9	1	PROM-PROGRAMMED	28480	08642-80293
<b>2708A TO 2721A</b>						
A3U23	08642-80388	3	1	PROM-PROGRAMMED	28480	08642-80388
A3U24	08642-80389	4	1	PROM-PROGRAMMED	28480	08642-80389
A3U25	08642-80390	7	1	PROM-PROGRAMMED	28480	08642-80390
A3U26	08642-80391	8	1	PROM-PROGRAMMED	28480	08642-80391
A3U27	08642-80392	9	1	PROM-PROGRAMMED	28480	08642-80392
A3U28	08642-80393	0	1	PROM-PROGRAMMED	28480	08642-80393
<b>2722A AND ABOVE</b>						
A3U23	08642-80488	4	1	PROM-PROGRAMMED	28480	08642-80488
	1200-0567	1	8	SOCKET-IC 28-CONT DIP DIP-SLDR	28480	1200-0567
A3U24	08642-80489	5	1	PROM-PROGRAMMED	28480	08642-80489
	1200-0567	1	8	SOCKET-IC 28-CONT DIP DIP-SLDR	28480	1200-0567
A3U25	08642-80490	8	1	PROM-PROGRAMMED	28480	08642-80490
	1200-0567	1	8	SOCKET-IC 28-CONT DIP DIP-SLDR	28480	1200-0567
A3U26	08642-80491	9	1	PROM-PROGRAMMED	28480	08642-80491
	1200-0567	1	8	SOCKET-IC 28-CONT DIP DIP-SLDR	28480	1200-0567
A3U27	08642-80492	0	1	PROM-PROGRAMMED	28480	08642-80492
	1200-0567	1	8	SOCKET-IC 28-CONT DIP DIP-SLDR	28480	1200-0567
A3U28	08642-80493	1	1	PROM-PROGRAMMED	28480	08642-80493
	1200-0567	1	8	SOCKET-IC 28-CONT DIP DIP-SLDR	28480	1200-0567
A3U29	1820-3100	8		IC DCDR TTL ALS BIN 3-TO-8-LINE 3-INP	28480	1820-3100
A3U30	1820-2485	0	1	IC RCVR TTL LS BUS OCTL	01295	SN75160N
A3U31	1820-2932	2	1	IC-PROGRAMMABLE TIMER MODULE;4MHZ INPUT	28480	1820-2932
<b>2427A TO 2514A</b>						
A3U32	08642-80144	9	1	PROM-PROGRAMMED	28480	08642-80144
A3U33	08642-80145	0	1	PROM-PROGRAMMED	28480	08642-80145
<b>2515A ONLY</b>						
A3U32	08642-80244	0	1	PROM-PROGRAMMED	28480	08642-80244
A3U33	08642-80245	1	1	PROM-PROGRAMMED	28480	08642-80245
<b>2516A TO 2521A</b>						
A3U32	08642-80444	2	1	PROM-PROGRAMMED	28480	08642-80444
A3U33	08642-80445	3	1	PROM-PROGRAMMED	28480	08642-80445
<b>2526A ONLY</b>						
A3U32	08642-80544	3	1	PROM-PROGRAMMED	28480	08642-80544
A3U33	08642-80545	4	1	PROM-PROGRAMMED	28480	08642-80545
<b>2527A TO 2530A</b>						
A3U32	08642-80644	4	1	PROM-PROGRAMMED	28480	08642-80644
A3U33	08642-80645	5	1	PROM-PROGRAMMED	28480	08642-80645
<b>2531A TO 2551A</b>						
A3U32	08642-80744	5	1	PROM-PROGRAMMED	28480	08642-80744
A3U33	08642-80745	6	1	PROM-PROGRAMMED	28480	08642-80745
<b>2601A TO 2615A</b>						
A3U32	08642-80844	6	1	PROM-PROGRAMMED	28480	08642-80844
A3U33	08642-80845	7	1	PROM-PROGRAMMED	28480	08642-80845
<b>2622A TO 2643A</b>						
A3U32	08642-80944	7	1	PROM-PROGRAMMED	28480	08642-80944
A3U33	08642-80945	8	1	PROM-PROGRAMMED	28480	08642-80945

See introduction to this section for ordering information.

\* Indicates factory selected value

Table 6-2. Replaceable Parts

Reference Designation	HP Part Number	C D	Qty	Description	Mfr Code	Mfr Part Number
2516A TO 2521A A3U32	08642-80444	2	1	PROM-PROGRAMMED	28480	08642-80444
	08642-80445	3	1	PROM-PROGRAMMED	28480	08642-80445
2526A ONLY A3U32	08642-80544	3	1	PROM-PROGRAMMED	28480	08642-80544
	08642-80545	4	1	PROM-PROGRAMMED	28480	08642-80545
2527A TO 2530A A3U32	08642-80644	4	1	PROM-PROGRAMMED	28480	08642-80644
	08642-80645	5	1	PROM-PROGRAMMED	28480	08642-80645
2531A TO 2551A A3U32	08642-80744	5	1	PROM-PROGRAMMED	28480	08642-80744
	08642-80745	6	1	PROM-PROGRAMMED	28480	08642-80745
2601A TO 2615A A3U32	08642-80844	6	1	PROM-PROGRAMMED	28480	08642-80844
	08642-80845	7	1	PROM-PROGRAMMED	28480	08642-80845
2622A TO 2643A A3U32	08642-80944	7	1	PROM-PROGRAMMED	28480	08642-80944
	08642-80945	8	1	PROM-PROGRAMMED	28480	08642-80945
2644A TO 2650A A3U32	08642-80194	9	1	PROM-PROGRAMMED	28480	08642-80194
	08642-80195	0	1	PROM-PROGRAMMED	28480	08642-80195
2651A TO 2707A A3U32	08642-80294	0	1	PROM-PROGRAMMED	28480	08642-80294
	08642-80295	1	1	PROM-PROGRAMMED	28480	08642-80295
2708A TO 2721A A3U32	08642-80394	1	1	PROM-PROGRAMMED	28480	08642-80394
	08642-80395	2	1	PROM-PROGRAMMED	28480	08642-80395
2722A TO 2733A A3U32	08642-80494	2	1	PROM-PROGRAMMED	28480	08642-80494
	1200-0567	1	8	SOCKET-IC 28-CONT DIP DIP-SLDR	28480	1200-0567
	08642-80495	3	1	PROM-PROGRAMMED	28480	08642-80495
	1200-0567	1	8	SOCKET-IC 28-CONT DIP DIP-SLDR	28480	1200-0567
2734A TO 2738A A3U32	08642-80594	3	1	PROM-PROGRAMMED	28480	08642-80594
	1200-0567	1	8	SOCKET-IC 28-CONT DIP DIP-SLDR	28480	1200-0567
	08642-80595	4	1	PROM-PROGRAMMED	28480	08642-80595
	1200-0567	1	8	SOCKET-IC 28-CONT DIP DIP-SLDR	28480	1200-0567
2748A AND ABOVE A3U32	08642-80694	4		PROM-PROGRAMMED	28480	08642-80694
	1200-0567	1	8	SOCKET-IC 28-CONT DIP DIP-SLDR	28480	1200-0567
	08642-80695	5		PROM-PROGRAMMED	28480	08642-80695
	1200-0567	1	8	SOCKET-IC 28-CONT DIP DIP-SLDR	28480	1200-0567
A3U34	1818-3183	2	4	IC CMOS 65536 (64K) STAT RAM 150-NS 3-S	28480	1818-3183
	1818-3183	2		IC CMOS 65536 (64K) STAT RAM 150-NS 3-S	28480	1818-3183
	1818-3183	2		IC CMOS 65536 (64K) STAT RAM 150-NS 3-S	28480	1818-3183
	1818-3183	2		IC CMOS 65536 (64K) STAT RAM 150-NS 3-S	28480	1818-3183
	1820-2547	5	1	IC RCVR TTL LS OCTL	01295	SN75162N
	1820-2551	1	1	IC-IMS9914 GBIB	28480	1820-2551
A3U39	0520-0128	7	2	SCREW-MACH 2-56 .25 TN-LG PAN-HD-POZI	00000	ORDER BY DESCRIPTION
	0610-0001	6	2	NUT-HEX-DBL-CHAM 2-56-THD .062-IN-THK	00000	ORDER BY DESCRIPTION
	1205-0081	9	1	HEATSINK SGL DIP	28480	1205-0581
	2190-0654	5	2	WASHER-LK HLCL 2.0 MM 2.1-MM-ID	28480	2190-0654
	1820-2656	7		IC GATE TTL ALS NAND QUAD 2-INP	01295	SN74ALS00N
2427A TO 2748A A3U41	1826-0759	9		IC COMPARATOR GP QUAD 14-DIP-C PKG	04713	LM339J
2807A AND ABOVE A3U41	1826-0138	8		IC COMPARATOR GP QUAD 14-DIP-C PKG	01295	LM339N
A3W1	1258-0227	1	1	JUMPER 18 GOLD PLTD BRONZE CONTACTS	28480	1258-0227
	1258-0218	0	1	MULTI-B-JUMP	28480	1258-0218
	1258-0209	9		JUMPER-REMOVABLE 2 POSITION; .200 IN	28480	1258-0209
	8159-0005	0	7	RESISTOR-ZERO OHMS 22 AWG LEAD DIA	28480	8159-0005
	8159-0005	0		RESISTOR-ZERO OHMS 22 AWG LEAD DIA	28480	8159-0005
A3W6	8159-0005	0		RESISTOR-ZERO OHMS 22 AWG LEAD DIA	28480	8159-0005
	8159-0005	0		RESISTOR-ZERO OHMS 22 AWG LEAD DIA	28480	8159-0005

See introduction to this section for ordering information.

\* Indicates factory selected value

Table 6-2. Replaceable Parts

Reference Designation	HP Part Number	C D	Qty	Description	Mfr Code	Mfr Part Number
<b>A4</b>						
A4	08642-60892	2	1	LATCH MODULE	28480	08642-60892
A4	08642-69892	0	1	LATCH MODULE (RESTORED)	28480	08642-69892
A4C1	0160-4835	7		CAPACITOR-FXD .1UF +-10% 50VDC CER	28480	0160-4835
A4C2	0160-4835	7		CAPACITOR-FXD .1UF +-10% 50VDC CER	28480	0160-4835
A4C3	0160-4787	8	9	CAPACITOR-FXD 22PF +-5% 100VDC CER 0+-30	28480	0160-4787
A4C4	0160-0576	5	181	CAPACITOR-FXD .1UF +-20% 50VDC CER	28480	0160-0576
2447A TO 2632A A4C5	0160-3879	7	177	CAPACITOR-FXD .01UF +-20% 100VDC CER	28480	0160-3879
2636A TO 2644A A4C5	0160-6222	0		CAPACITOR-FXD .1UF +-10% 50VDC CER	28480	0160-6222
2647A AND ABOVE A4C5	0160-3879	7	177	CAPACITOR-FXD .01UF +-20% 100VDC CER	28480	0160-3879
A4C6	0180-0228	6		CAPACITOR-FXD 22UF+-10% 15VDC TA	56289	150D226X9015B2
A4C7	0180-3074	6	2	CAPACITOR-FXD 15UF+-20% 30VDC TA	28480	0180-3074
A4C8	0180-3074	6		CAPACITOR-FXD 15UF+-20% 30VDC TA	28480	0180-3074
A4C9	0180-0100	3		CAPACITOR-FXD 4.7UF+-10% 35VDC TA	56289	150D475X9035B2
A4C10	0180-0100	3		CAPACITOR-FXD 4.7UF+-10% 35VDC TA	56289	150D475X9035B2
A4C11	0180-0100	3		CAPACITOR-FXD 4.7UF+-10% 35VDC TA	56289	150D475X9035B2
A4C12	0160-4835	7		CAPACITOR-FXD .1UF +-10% 50VDC CER	28480	0160-4835
A4C13	0160-4835	7		CAPACITOR-FXD .1UF +-10% 50VDC CER	28480	0160-4835
A4C14	0160-4835	7		CAPACITOR-FXD .1UF +-10% 50VDC CER	28480	0160-4835
A4C15	0160-4835	7		CAPACITOR-FXD .1UF +-10% 50VDC CER	28480	0160-4835
A4C16	0160-4835	7		CAPACITOR-FXD .1UF +-10% 50VDC CER	28480	0160-4835
A4C17	0160-4835	7		CAPACITOR-FXD .1UF +-10% 50VDC CER	28480	0160-4835
A4C18	0160-4835	7		CAPACITOR-FXD .1UF +-10% 50VDC CER	28480	0160-4835
A4C19	0160-4835	7		CAPACITOR-FXD .1UF +-10% 50VDC CER	28480	0160-4835
A4C20	0160-4835	7		CAPACITOR-FXD .1UF +-10% 50VDC CER	28480	0160-4835
A4C21	0160-4835	7		CAPACITOR-FXD .1UF +-10% 50VDC CER	28480	0160-4835
A4C22	0160-4835	7		CAPACITOR-FXD .1UF +-10% 50VDC CER	28480	0160-4835
A4C23	0160-4835	7		CAPACITOR-FXD .1UF +-10% 50VDC CER	28480	0160-4835
A4C24	0160-4835	7		CAPACITOR-FXD .1UF +-10% 50VDC CER	28480	0160-4835
A4C25	0160-4835	7		CAPACITOR-FXD .1UF +-10% 50VDC CER	28480	0160-4835
A4C26	0160-4835	7		CAPACITOR-FXD .1UF +-10% 50VDC CER	28480	0160-4835
A4C27	0160-4835	7		CAPACITOR-FXD .1UF +-10% 50VDC CER	28480	0160-4835
A4C28	0160-4835	7		CAPACITOR-FXD .1UF +-10% 50VDC CER	28480	0160-4835
A4C29	0160-4835	7		CAPACITOR-FXD .1UF +-10% 50VDC CER	28480	0160-4835
A4C30	0160-4835	7		CAPACITOR-FXD .1UF +-10% 50VDC CER	28480	0160-4835
A4C31	0160-4835	7		CAPACITOR-FXD .1UF +-10% 50VDC CER	28480	0160-4835
A4C32	0160-4835	7		CAPACITOR-FXD .1UF +-10% 50VDC CER	28480	0160-4835
A4C33	0160-4835	7		CAPACITOR-FXD .1UF +-10% 50VDC CER	28480	0160-4835
A4C34	0160-4835	7		CAPACITOR-FXD .1UF +-10% 50VDC CER	28480	0160-4835
A4C35	0160-4835	7		CAPACITOR-FXD .1UF +-10% 50VDC CER	28480	0160-4835
A4C36	0160-4835	7		CAPACITOR-FXD .1UF +-10% 50VDC CER	28480	0160-4835
2447A TO 2517A A4C37	0160-4787	8		CAPACITOR-FXD 22PF +-5% 100VDC CER 0+-30	28480	0160-4787
2521A AND ABOVE A4C37	0160-0571	0		CAPACITOR-FXD 470PF +-20% 100VDC CER	28480	0160-0571
A4C38	0160-4809	5	1	CAPACITOR-FXD 390PF +-5% 100VDC CER	28480	0160-4809
2427A TO 2517A A4C39-C42				NOT ASSIGNED		
2521A AND ABOVE A4C39	0160-0576	5		CAPACITOR-FXD .1UF +-20% 50VDC CER	28480	0160-0576
2521A TO 2630A A4C40	0160-0576	5		CAPACITOR-FXD .1UF +-20% 50VDC CER	28480	0160-0576
2636A AND ABOVE A4C40				NOT ASSIGNED		
2521A AND ABOVE A4C41	0160-0576	5		CAPACITOR-FXD .1UF +-20% 50VDC CER	28480	0160-0576
A4C42	0160-0576	5		CAPACITOR-FXD .1UF +-20% 50VDC CER	28480	0160-0576

See introduction to this section for ordering information.

\* Indicates factory selected value

Table 6-2. Replaceable Parts

Reference Designation	HP Part Number	C D	Qty	Description	Mfr Code	Mfr Part Number
A4CR1	1901-0050	3		DIODE-SWITCHING 80V 200MA 2NS DO-35	28480	1901-0050
A4CR2	1901-0050	3		DIODE-SWITCHING 80V 200MA 2NS DO-35	28480	1901-0050
A4CR3	1901-0050	3		DIODE-SWITCHING 80V 200MA 2NS DO-35	28480	1901-0050
A4CR4	1901-0050	3		DIODE-SWITCHING 80V 200MA 2NS DO-35	28480	1901-0050
A4CR5	1901-0050	3		DIODE-SWITCHING 80V 200MA 2NS DO-35	28480	1901-0050
A4CR6	1901-0050	3		DIODE-SWITCHING 80V 200MA 2NS DO-35	28480	1901-0050
A4CR7	1901-0539	3	16	DIODE-SM SIG SCHOTTKY	28480	1901-0539
A4CR8	1901-0539	3		DIODE-SM SIG SCHOTTKY	28480	1901-0539
A4CR9	1901-0050	3		DIODE-SWITCHING 80V 200MA 2NS DO-35	28480	1901-0050
A4CR10	1901-0050	3		DIODE-SWITCHING 80V 200MA 2NS DO-35	28480	1901-0050
A4CR11	1901-0050	3		DIODE-SWITCHING 80V 200MA 2NS DO-35	28480	1901-0050
A4CR12	1901-0050	3		DIODE-SWITCHING 80V 200MA 2NS DO-35	28480	1901-0050
A4J1	1251-5946	7	1	CONNECTOR 12-PIN M POST TYPE	28480	1251-5946
A4K1	0490-0916	6	2	RELAY-REED 1A 500MA 100VDC 5VDC-COIL	28480	0490-0916
A4L1	9100-1788	6		CORE-FERRITE CHOKE-WIDEBAND; IMP:>680	28480	9100-1788
A4L2	9100-1788	6		CORE-FERRITE CHOKE-WIDEBAND; IMP:>680	28480	9100-1788
A4L3	9100-1788	6		CORE-FERRITE CHOKE-WIDEBAND; IMP:>680	28480	9100-1788
A4MP1	1400-0249	0		CABLE TIE .062-.625-DIA .091-WD NYL	06383	PLT1M-8
A4MP2	5040-6067	2		EXTR PC BD WHT	28480	5040-6067
	1480-0073	6		PIN-ROLL .062-IN-DIA .25-IN-LG BE-CU	28480	1480-0073
A4MP3	5040-6068	3		EXTR PC BD BLK	28480	5040-6068
	1480-0073	6		PIN-ROLL .062-IN-DIA .25-IN-LG BE-CU	28480	1480-0073
A4MP4	08642-40032	0		SPACER	28480	08642-40032
A4P1	1251-7307	8		CONN POST TYPE .100-PIN-SPCG 50-CONT	28480	1251-7307
A4P2	1251-7307	8		CONN POST TYPE .100-PIN-SPCG 50-CONT	28480	1251-7307
A4P3	1251-7307	8		CONN POST TYPE .100-PIN-SPCG 50-CONT	28480	1251-7307
A4P4	1251-7307	8		CONN POST TYPE .100-PIN-SPCG 50-CONT	28480	1251-7307
A4R1	0757-0280	3		RESISTOR 1K 1% .125W F TC=0+-100	24546	C4-1/8-T0-1001-F
A4R2	0698-0084	9		RESISTOR 2.15K 1% .125W F TC=0+-100	24546	C4-1/8-T0-2151-F
A4R3	0757-0280	3		RESISTOR 1K 1% .125W F TC=0+-100	24546	C4-1/8-T0-1001-F
A4R4	0757-0280	3		RESISTOR 1K 1% .125W F TC=0+-100	24546	C4-1/8-T0-1001-F
A4R5	0698-0084	9		RESISTOR 2.15K 1% .125W F TC=0+-100	24546	C4-1/8-T0-2151-F
A4R6	0698-3454	3	3	RESISTOR 215K 1% .125W F TC=0+-100	24546	C4-1/8-T0-2153-F
A4R7	0757-0280	3		RESISTOR 1K 1% .125W F TC=0+-100	24546	C4-1/8-T0-1001-F
A4R8	0757-0280	3		RESISTOR 1K 1% .125W F TC=0+-100	24546	C4-1/8-T0-1001-F
A4R9	0698-3452	1		RESISTOR 147K 1% .125W F TC=0+-100	24546	C4-1/8-T0-1473-F
<i>2427A TO 2647 A4R10</i>	0757-0394	0	7	RESISTOR 51.1 1% .125W F TC=0+-100	24546	C4-1/8-T0-51R1-F
<i>2717A AND ABOVE A4R10</i>	0699-2279	0		RESISTOR 51.1 1% .125W F TC=0+-100	24546	C4-1/8-T0-51R1-F
A4R11	0757-0462	3	2	RESISTOR 75K 1% .125W F TC=0+-100	24546	C4-1/8-T0-7502-F
A4R12	0757-0280	3		RESISTOR 1K 1% .125W F TC=0+-100	24546	C4-1/8-T0-1001-F
A4R13	0757-0280	3		RESISTOR 1K 1% .125W F TC=0+-100	24546	C4-1/8-T0-1001-F
A4R14				NOT ASSIGNED		
A4R15	0698-3451	0	2	RESISTOR 133K 1% .125W F TC=0+-100	24546	C4-1/8-T0-1333-F
<i>2717A TO 2736A A4R16</i>	0757-0458	7	2	RESISTOR 51.1K 1% .125W F TC=0+-100	24546	C4-1/8-T0-5112-F
<i>2737A AND ABOVE A4R16</i>	0698-3228	9		RESISTOR 49.9K 1% .125W F TC=0+-100	28480	0698-3228
A4R17	0757-0465	6		RESISTOR 100K 1% .125W F TC=0+-100	24546	C4-1/8-T0-1003-F
A4R18	0757-0465	6		RESISTOR 100K 1% .125W F TC=0+-100	24546	C4-1/8-T0-1003-F
A4R19	0698-3450	9		RESISTOR 42.2K 1% .125W F TC=0+-100	24546	C4-1/8-T0-4222-F
A4R20	0757-0280	3		RESISTOR 1K 1% .125W F TC=0+-100	24546	C4-1/8-T0-1001-F
A4R21	0698-3155	1		RESISTOR 4.64K 1% .125W F TC=0+-100	24546	C4-1/8-T0-4641-F
A4R22	0698-3155	1		RESISTOR 4.64K 1% .125W F TC=0+-100	24546	C4-1/8-T0-4641-F
A4R23	0698-0084	9		RESISTOR 2.15K 1% .125W F TC=0+-100	24546	C4-1/8-T0-2151-F
A4R24	0698-3454	3		RESISTOR 215K 1% .125W F TC=0+-100	24546	C4-1/8-T0-2153-F
A4R25	0757-0280	3		RESISTOR 1K 1% .125W F TC=0+-100	24546	C4-1/8-T0-1001-F
A4R26	0757-0280	3		RESISTOR 1K 1% .125W F TC=0+-100	24546	C4-1/8-T0-1001-F
A4R27	0757-0280	3		RESISTOR 1K 1% .125W F TC=0+-100	24546	C4-1/8-T0-1001-F
A4R28				NOT ASSIGNED		
A4R29	0698-3449	6	2	RESISTOR 28.7K 1% .125W F TC=0+-100	24546	C4-1/8-T0-2872-F

See introduction to this section for ordering information.

\* Indicates factory selected value



Table 6-2. Replaceable Parts

Reference Designation	HP Part Number	C D	Qty	Description	Mfr Code	Mfr Part Number
2427A TO 2630A A4R30-37				NOT ASSIGNED		
2636A AND ABOVE						
A4R30	0757-0394	0		RESISTOR 51.1 1% .125W F TC=0+-100	24546	C4-1/8-TO-51R1-F
A4R31	0757-0346	2		RESISTOR 10 1% .125W F TC=0+-100	24546	C4-1/8-TO-10RO-F
A4R32	0757-0346	2		RESISTOR 10 1% .125W F TC=0+-100	24546	C4-1/8-TO-10RO-F
A4R33	0698-3443	9		RESISTOR 2.26K .25% .5W F TC=0+-100	28480	0698-3443
A4R34	0757-0458	7		RESISTOR 51.1K 1% .125W F TC=0+-100	24546	C4-1/8-TO-5112-F
A4R35	0757-0394	0		RESISTOR 51.1 1% .125W F TC=0+-100	24546	C4-1/8-TO-51R1-F
A4R36	0757-0346	2		RESISTOR 10 1% .125W F TC=0+-100	24546	C4-1/8-TO-10RO-F
A4R37	0757-0346	2		RESISTOR 10 1% .125W F TC=0+-100	24546	C4-1/8-TO-10RO-F
A4S1	3101-2751	1		SWITCH-RKR DIP-RKR-ASSY 2-1A .015A 24VDC	28480	3101-2751
A4TP1	0360-0535	0		TERMINAL TEST POINT PCB	00000	ORDER BY DESCRIPTION
A4TP2	0360-0535	0		TERMINAL TEST POINT PCB	00000	ORDER BY DESCRIPTION
A4TP3	0360-0535	0		TERMINAL TEST POINT PCB	00000	ORDER BY DESCRIPTION
A4U1	1820-2889	8	1	IC GATE TTL ALS AND TPL 3-INP	28480	1820-2889
A4U2	1820-2053	8	1	IC OADR TTL LS BCD 4-TO-16-LINE	18324	74LS154N
A4U3	1820-3100	8		IC OADR TTL ALS BIN 3-TO-8-LINE 3-INP	28480	1820-3100
A4U4	1826-0753	3	2	IC OP AMP LOW-BIAS-H-IMPQ QUAD 14-DIP-C	04713	MC34004BL
A4U5	1826-1206	3	2	D/A 10-BIT 20-DIP-C CMOS	28480	1826-1206
A4U6	1820-1858	9		IC FF TTL LS D-TYPE OCTL	01295	SN74LS377N
A4U7	1820-1858	9	8	IC FF TTL LS D-TYPE OCTL	01295	SN74LS377N
A4U8	1820-3121	3	2	IC TRANSCIEVER TTL ALS BUS OCTL	28480	1820-3121
A4U9	1820-1858	9	8	IC FF TTL LS D-TYPE OCTL	01295	SN74LS377N
A4U10	1820-3121	3	2	IC TRANSCIEVER TTL ALS BUS OCTL	28480	1820-3121
A4U11	1820-1858	9	8	IC FF TTL LS D-TYPE OCTL	01295	SN74LS377N
A4U12	1820-1858	9		IC FF TTL LS D-TYPE OCTL	01295	SN74LS377N
A4U13	1820-1858	9	8	IC FF TTL LS D-TYPE OCTL	01295	SN74LS377N
A4U14	1820-1858	9		IC FF TTL LS D-TYPE OCTL	01295	SN74LS377N
A4U15	1820-1858	9		IC FF TTL LS D-TYPE OCTL	01295	SN74LS377N
A4U16	1820-1858	9	8	IC FF TTL LS D-TYPE OCTL	01295	SN74LS377N
A4U17	1820-1858	9	8	IC FF TTL LS D-TYPE OCTL	01295	SN74S377N
A4U18	1820-1858	9	8	IC FF TTL LS D-TYPE OCTL	01295	SN74S377N
A4U19	1820-1858	9	8	IC FF TTL LS D-TYPE OCTL	01295	SN74S377N
A4U20				NOT ASSIGNED		
A4U21	1820-2951	5	2	IC DRVR TTL ALS BUS OCTL	28480	1820-2951
A4U22	1820-2951	5		IC DRVR TTL ALS BUS OCTL	28480	1820-2951
A4U23	1826-1206	3		D/A 10-BIT 20-DIP-C CMOS	28480	1826-1206
A4U24	1820-3467	0	3	IC DRVR TTL ALS OR HEX 2-INP	28480	1820-3467
A4U25				NOT ASSIGNED		
A4U26				NOT ASSIGNED		
A4U27	1820-3378	2	6	IC LCH TTL ALS D-TYPE NEG-EDGE-TRIG OCTL	28480	1820-3378
A4U28	1820-3378	2		IC LCH TTL ALS D-TYPE NEG-EDGE-TRIG OCTL	28480	1820-3378
A4U29	1820-3378	2		IC LCH TTL ALS D-TYPE NEG-EDGE-TRIG OCTL	28480	1820-3378
A4U30	1820-3467	0		IC DRVR TTL ALS OR HEX 2-INP	28480	1820-3467
A4U31	1820-3378	2		IC LCH TTL ALS D-TYPE NEG-EDGE-TRIG OCTL	28480	1820-3378
A4U32	1820-3467	0		IC DRVR TTL ALS OR HEX 2-INP	28480	1820-3467
A4U33	1820-3378	2		IC LCH TTL ALS D-TYPE NEG-EDGE-TRIG OCTL	28480	1820-3378
A4U34	1820-3372	6	1	IC GATE TTL ALS NAND 13-INP	28480	1820-3372
A4U35	1820-3378	2		IC LCH TTL ALS D-TYPE NEG-EDGE-TRIG OCTL	28480	1820-3378

See introduction to this section for ordering information.

\* Indicates factory selected value

Table 6-2. Replaceable Parts

Reference Designation	HP Part Number	C D	Qty	Description	Mfr Code	Mfr Part Number
A4U36				NOT ASSIGNED		
A4U37	1826-0605	4		IC MULTIPLXR 8-CHAN-ANLG 16-DIP-C PKG	17856	DG508BK
A4U38	1820-2488	3		IC FF TTL ALS D-TYPE POS-EDGE-TRIG	01295	SN74ALS74N
A4U39	1826-0605	4		IC MULTIPLXR 8-CHAN-ANLG 16-DIP-C PKG	17856	DG508BK
A4U40				NOT ASSIGNED		
A4U41				NOT ASSIGNED		
A4U42	1826-0792	0		IC COMPARATOR PRCN QUAD 16-DIP-C PKG	34371	HA1-4905-5
A4U43	1826-0792	0		IC COMPARATOR PRCN QUAD 16-DIP-C PKG	34371	HA1-4905-5
A4U44	1820-1440	5		IC LCH TTL LS QUAD	01295	SN74LS279N
A4U45	1820-1440	5		IC LCH TTL LS QUAD	01295	SN74LS279N
A4U46	1826-0742	0	1	IC V RGLTR-V-REF-FXD 10V TO-5 PKG	28480	1826-0742
	1200-0173	5	20	INSULATOR-XSTR OAP-GL	28480	1200-0173
A4U47	1820-1416	5	8	IC SCHMITT-TRIG TTL LS INV HEX 1-INP	01295	SN74LS14N
A4W1	08642-60077	5	1	CABLE COAX 4	28480	08642-60077

See introduction to this section for ordering information.

\* Indicates factory selected value

Table 6-2. Replaceable Parts

Reference Designation	HP Part Number	C D	Qty	Description	Mfr Code	Mfr Part Number
<b>A5</b>						
A5	08642-60126	5	1	POWER SUPPLY/CONTROL ASSEMBLY	28480	08642-60126
A5J1	1251-8816	6	1	CONN-POST TYPE .100-PIN-SPCG 40-CONT	28480	1251-8816
A5J2	1251-8813	3	2	CONN-POST TYPE .100-PIN-SPCG 14-CONT	28480	1251-8813
A5J3	1251-8815	5	3	CONN-POST TYPE .100-PIN-SPCG 26-CONT	28480	1251-8815
A5J4	1251-8814	4	3	CONN-POST TYPE .100-PIN-SPCG 16-CONT	28480	1251-8814
A5J5	1251-8815	5	5	CONN-POST TYPE .100-PIN-SPCG 26-CONT	28480	1251-8815
A5J6	1251-8814	4		CONN-POST TYPE .100-PIN-SPCG 16-CONT	28480	1251-8814
A5J7	1251-8815	5		CONN-POST TYPE .100-PIN-SPCG 26-CONT	28480	1251-8815
A5J8	1251-8817	7	2	CONN-POST TYPE .100-PIN-SPCG 34-CONT	28480	1251-8817
A5J9	1251-8817	7		CONN-POST TYPE .100-PIN-SPCG 34-CONT	28480	1251-8817
A5J10	1251-8814	4		CONN-POST TYPE .100-PIN-SPCG 16-CONT	28480	1251-8814
A5J11	1251-8812	2		CONN-POST TYPE .100-PIN-SPCG 20-CONT	28480	1251-8812
A5J12	1251-8811	1	2	CONN-POST TYPE .100-PIN-SPCG 50-CONT	28480	1251-8811
A5J13	1251-8811	1		CONN-POST TYPE .100-PIN-SPCG 50-CONT	28480	1251-8811
A5J14	1251-7300	1	4	CONN-POST TYPE .100-PIN-SPCG 50-CONT	28480	1251-7300
A5J15	1251-7300	1		CONN-POST TYPE .100-PIN-SPCG 50-CONT	28480	1251-7300
A5J16	1251-7300	1		CONN-POST TYPE .100-PIN-SPCG 50-CONT	28480	1251-7300
A5J17	1251-7300	1		CONN-POST TYPE .100-PIN-SPCG 50-CONT	28480	1251-7300
A5J18	08642-80014	2	2	CONN DIST PCB	28480	08642-80014
A5J19	08642-80014	2		CONN DIST PCB	28480	08642-80014
A5J20	1251-4927	2	2	CONNECTOR 16-PIN M POST TYPE	28480	1251-4927
A5J21	1251-4927	2		CONNECTOR 16-PIN M POST TYPE	28480	1251-4927
A5W1-1W131	7175-0057	5	131	RESISTOR-ZERO OHMS SOLID TINNED COPPER	28480	7175-0057

See introduction to this section for ordering information.

\* Indicates factory selected value



Table 6-2. Replaceable Parts

Reference Designation	HP Part Number	C D	Qty	Description	Mfr Code	Mfr Part Number
<b>A6</b>						
A6	08642-60893	3	1	FM LOOP/COUNTER/TIMEBASE MODULE	28480	08642-60893
A6	08642-69893	1	1	FM LOOP/COUNTER/TIMEBASE MODULE (RESTORED)	28480	08642-69893
A6FL2	08642-80015	3	1	FLTR LP 3M BKT	28480	08642-80015
A6MP1	08642-20001	1	1	COVER FM VCO	28480	08642-20001
A6MP2	08642-40053	5	4	GASKET FD/THRU13	28480	08642-40053
A6MP3	08642-00087	1	7	FOAM-DAMPING	28480	08642-00087
A6MP4	08642-20002	2	1	BASE FM TIMEBASE	28480	08642-20002
A6MP5	08642-00061	1	1	GASKET 11 PN FLT	28480	08642-00061
A6MP6	0515-1521	5		SCREW-MACH M3 X 0.5 5MM-LG 90-DEG-FL-HD (ATTACH FILTER TO BASE)	28480	0515-1521
A6MP7	08642-20003	3	1	COVER FM CNTR/TB	28480	08642-20003
A6MP8	08642-40056	8	1	GASKET FEEDTHRU6	28480	08642-40056
A6MP9	0515-0684	9	30	SCREW-MACH M4 X 0.7 6MM-LG PAN-HD (ATTACH BOARDS TO BASE)	28480	0515-0684
A6MP10	0515-0381	3	147	SCREW-MACH M4 X 0.7 10MM-LG PAN-HD (ATTACH COVERS TO BASE)	00000	ORDER BY DESCRIPTION
A6MP11	8160-0472	8	101	RFI ROUND STRIP BE-CU SN-PL .093-IN-OD (SPIRA SHIELD)	28480	8160-0472
A6MP12	08642-00183	8	2	SLIDE-MODULE	28480	08642-00183
A6MP13	08642-00183	8	1	SLIDE-MODULE	28480	08642-00183
A6MP14	0515-1102	8	43	SCREW-MACH M3 X 0.5 8MM-LG 90-DEG-FLH-HD (ATTACH MODULE SLIDE)	28480	0515-1102
A6MP15	08642-80064	2	1	LABEL-FM 60001	28480	08642-80064
2427A TO 2714A A6MP16				NOT ASSIGNED		
2751A AND ABOVE A6MP16	1400-0015	8		CLAMP-CABLE .25-DIA .375-WD STL	28480	1400-0015
A6W1	5061-4811	4	1	CBL-COAX 94 (A6A2J4 TO A6A1J3)	28480	5061-4811

See introduction to this section for ordering information.

\* Indicates factory selected value



Table 6-2. Replaceable Parts

Reference Designation	HP Part Number	C D	Qty	Description	Mfr Code	Mfr Part Number
<b>A6A1</b>	08642-60101	6	1	FM VCO ASSEMBLY	28480	08642-60101
A6A1C1				NOT ASSIGNED		
A6A1C2	0180-2374	7	3	CAPACITOR-FXD 100UF+-10% 20VDC TA	56289	150D107X9020X2
A6A1C3				NOT ASSIGNED		
A6A1C4	0180-0491	5		CAPACITOR-FXD 10UF+-20% 25VDC TA	28480	0180-0491
A6A1C5	0121-0452	4	7	CAPACITOR-V TRMR-AIR 1.3-5.4PF 175V	74970	187-0103-028
A6A1C6	0160-6434	6	1	CAPACITOR-FXD 5.6PF +- .5PF 100VDC CER	28480	0160-6434
A6A1C7	0160-6435	7	1	CAPACITOR-FXD 13PF +-5% 100VDC CER	28480	0160-6435
A6A1C8	0160-4040	6		CAPACITOR-FXD 1000PF +-5% 100VDC CER	28480	0160-4040
A6A1C9				NOT ASSIGNED		
A6A1C10	0160-4040	6		CAPACITOR-FXD 1000PF +-5% 100VDC CER	28480	0160-4040
A6A1C11	0160-4040	6		CAPACITOR-FXD 1000PF +-5% 100VDC CER	28480	0160-4040
A6A1C12	0160-4494	4		CAPACITOR-FXD 39PF +-5% 200VDC CER 0+-30	28480	0160-4494
A6A1C13	0160-4618	4	1	CAPACITOR-FXD 3.9PF +- .25PF 200VDC CER	28480	0160-4618
A6A1C14	0160-3874	2		CAPACITOR-FXD 10PF +- .5PF 200VDC CER	28480	0160-3874
A6A1C15	0160-4040	6		CAPACITOR-FXD 1000PF +-5% 100VDC CER	28480	0160-4040
A6A1C16	0160-4040	6		CAPACITOR-FXL 1000PF +-5% 100VDC CER	28480	0160-4040
A6A1C17	0160-4040	6		CAPACITOR-FXD 1000PF +-5% 100VDC CER	28480	0160-4040
A6A1C18	0160-4031	5	3	CAPACITOR-FXD 330PF +-5% 100VDC CER	28480	0160-4031
A6A1C19				NOT ASSIGNED		
A6A1C20	0160-3879	7		CAPACITOR-FXD .01UF +-20% 100VDC CER	28480	0160-3879
A6A1C21	0160-3878	6	9	CAPACITOR-FXD 1000PF + 20% 100VDC CER	28480	0160-3878
A6A1C22				NOT ASSIGNED		
A6A1C23	0160-3879	7		CAPACITOR-FXD .01UF +-20% 100VDC CER	28480	0160-3879
A6A1C24				NOT ASSIGNED		
A6A1C25	0160-3878	6		CAPACITOR-FXD 1000PF +-20% 100VDC CER	28480	0160-3878
A6A1C26	0160-4897	1	1	CAPACITOR-FXD 4.7PF +- .1PF 200VDC CER	28480	0160-4897
A6A1C27	0160-4835	7		CAPACITOR-FXD .1UF +-10% 50VDC CER	28480	0160-4835
A6A1C28	0160-4832	4		CAPACITOR-FXD .01UF +-10% 100VDC CER	28480	0160-4832
A6A1C29				NOT ASSIGNED		
A6A1C30	0160-4832	4		CAPACITOR-FXD .01UF +-10% 100VDC CER	28480	0160-4832
A6A1C31	0160-4835	7		CAPACITOR-FXD .1UF +-10% 50VDC CER	28480	0160-4835
A6A1C32	0180-2683	1	3	CAPACITOR-FXD 4.7UF+-20% 35VDC TA	28480	0180-2683
A6A1C33	0180-2683	1		CAPACITOR-FXD 4.7UF+-20% 35VDC TA	28480	0180-2683
A6A1C34	0180-0491	5		CAPACITOR-FXD 10UF+-20% 25VDC TA	28480	0180-0491
A6A1C35				NOT ASSIGNED		
A6A1C36	0180-0491	5		CAPACITOR-FXD 10UF+-20% 25VDC TA	28480	0180-0491
A6A1C37				NOT ASSIGNED		
A6A1C38	0160-4835	7		CAPACITOR-FXD .1UF +-10% 50VDC CER	28480	0160-4835
A6A1C39	0160-4835	7		CAPACITOR-FXD .1UF +-10% 50VDC CER	28480	0160-4835
A6A1C40				NOT ASSIGNED		
A6A1C41	0160-5866	6	1	CAPACITOR-FXD .12UF +-5% 50VDC CER 0+-30	28480	0160-5866
A6A1C42	0160-5623	3	1	CAPACITOR-FXD .082UF +-2% 50VDC	28480	0160-5623
A6A1C43	0160-5622	2	1	CAPACITOR-FXD 1.25UF +-2% 50VDC	28480	0160-5622
A6A1C44	0160-4835	7		CAPACITOR-FXD .1UF +-10% 50VDC CER	28480	0160-4835
A6A1C45	0160-4835	7		CAPACITOR-FXD .1UF +-10% 50VDC CER	28480	0160-4835
A6A1C46	0160-5867	7	1	CAPACITOR-FXD .047UF +-5% 50VDC CER	28480	0160-5867
A6A1C47	0160-3400	0	2	CAPACITOR-FXD .01UF +-5% 200VDC	28480	0160-3400
A6A1C48	0160-3400	0		CAPACITOR-FXD .01UF +-5% 200VDC	28480	0160-3400
A6A1C49	0160-3324	7	5	CAPACITOR-FXD 1UF +-5% 100VDC MET-POLYC	28480	0160-3324
A6A1C50	0160-0302	5	1	CAPACITOR-FXD .018UF +-10% 200VDC POLYE	28480	0160-0302
A6A1C51	0160-4832	4		CAPACITOR-FXD .01UF +-10% 100VDC CER	28480	0160-4832
A6A1C52	0160-2290	4	1	CAPACITOR-FXD .15UF +-10% 80VDC POLYE	28480	0160-2290
A6A1C53	0160-4835	7		CAPACITOR-FXD .1UF +-10% 50VDC CER	28480	0160-4835
A6A1C54	0160-4835	7		CAPACITOR-FXD .1UF +-10% 50VDC CER	28480	0160-4835
A6A1C55	0180-0491	5		CAPACITOR-FXD 10UF+-20% 25VDC TA	28480	0180-0491
A6A1C56	0160-4835	7		CAPACITOR-FXD .1UF +-10% 50VDC CER	28480	0160-4835
A6A1C57	0160-4787	8		CAPACITOR-FXD 22PF +-5% 100VDC CER 0+-30	28480	0160-4787
A6A1C58	0160-4789	0	2	CAPACITOR-FXD 15PF +-5% 100VDC CER 0+-30	28480	0160-4789
A6A1C59				NOT ASSIGNED		
A6A1C60	0160-3501	2	1	CAPACITOR-FXD 4UF +-10% 50VDC MET-POLYC	28480	0160-3501
A6A1C61	0160-3324	7		CAPACITOR-FXD 1UF +-5% 100VDC MET-POLYC	28480	0160-3324
A6A1C62	0160-4832	4		CAPACITOR-FXD .01UF +-10% 100VDC CER	28480	0160-4832
A6A1C63	0160-4835	7		CAPACITOR-FXD .1UF +-10% 50VDC CER	28480	0160-4835
A6A1C64	0160-4835	7		CAPACITOR-FXD .1UF +-10% 50VDC CER	28480	0160-4835
A6A1C65	0160-4789	0		CAPACITOR-FXD 15PF +-5% 100VDC CER 0+-30	28480	0160-4789

See introduction to this section for ordering information.

\* Indicates factory selected value

Table 6-2. Replaceable Parts

Reference Designation	HP Part Number	C D	Qty	Description	Mfr Code	Mfr Part Number
A6A1C66	0160-4805	1	1	CAPACITOR-FXD 47PF +-5% 100VDC CER 0+-30	28480	0160-4805
A6A1C67				NOT ASSIGNED		
A6A1C68	0160-4835	7		CAPACITOR-FXD .1UF +-10% 50VDC CER	28480	0160-4835
A6A1C69	0160-4835	7		CAPACITOR-FXD .1UF +-10% 50VDC CER	28480	0160-4835
A6A1C70	0160-4835	7		CAPACITOR-FXD .1UF +-10% 50VDC CER	28480	0160-4835
A6A1C71	0160-4835	7		CAPACITOR-FXD .1UF +-10% 50VDC CER	28480	0160-4835
A6A1C72	0160-3879	7		CAPACITOR-FXD .01UF +-20% 100VDC CER	28480	0160-3879
A6A1C73	0160-3879	7		CAPACITOR-FXD .01UF +-20% 100VDC CER	28480	0160-3879
A6A1C74	0160-3878	6		CAPACITOR-FXD 1000PF +-20% 100VDC CER	28480	0160-3878
A6A1C75	0160-4822	2		CAPACITOR-FXD 1000PF +-5% 100VDC CER	28480	0160-4822
A6A1C76	0160-4835	7		CAPACITOR-FXD .1UF +-10% 50VDC CER	28480	0160-4835
A6A1C77	0180-2618	2	12	CAPACITOR-FXD 33UF+-10% 10VDC TA	25088	D33GS1B10K
A6A1C78	0160-4832	4		CAPACITOR-FXD .01UF +-10% 100VDC CER	28480	0160-4832
A6A1C79	0180-2661	5	4	CAPACITOR-FXD 1UF+-10% 50VDC TA	25088	D1R0GS1A50K
A6A1C80	0160-3324	7		CAPACITOR-FXD 1UF +-5% 100VDC MET-POLYC	28480	0160-3324
A6A1C81				NOT ASSIGNED		
A6A1C82	0160-3879	7		CAPACITOR-FXD .01UF +-20% 100VDC CER	28480	0160-3879
A6A1C83	0160-3879	7		CAPACITOR-FXD .01UF +-20% 100VDC CER	28480	0160-3879
A6A1C84	0160-3879	7		CAPACITOR-FXD .01UF +-20% 100VDC CER	28480	0160-3879
A6A1C85	0160-3879	7		CAPACITOR-FXD .01UF +-20% 100VDC CER	28480	0160-3879
A6A1C86	0160-3879	7		CAPACITOR-FXD .01UF +-20% 100VDC CER	28480	0160-3879
A6A1C87	0180-2618	2		CAPACITOR-FXD 33UF+-10% 10VDC TA	25088	D33GS1B10K
A6A1C88	0160-3879	7		CAPACITOR-FXD .01UF +-20% 100VDC CER	28480	0160-3879
A6A1C89	0160-4350	1		CAPACITOR-FXD 150PF +-5% 200VDC CER	28480	0160-4547
2427A TO 2543A A6A1C90				NOT ASSIGNED		
2550A TO 2751A A6A1C90	0160-4835	7	1	CAPACITOR-FXD .1UF +10% 50VDC CER	28480	0160-4835
2824A AND ABOVE A6A1C90	0160-5098	6	1	CAPACITOR-FXD .22UF +-10% 50VDC CER	16299	CAC05X7R22RJO50A
A6A1CR1	0122-0164	7	4	DIODE-VVC 47PF 5% BVR=60V DO-7 Q=200-MIN	28480	0122-0164
A6A1CR2	0122-0164	7		DIODE-VVC 47PF 5% BVR=60V DO-7 Q=200-MIN	28480	0122-0164
A6A1CR3	0122-0164	7		DIODE-VVC 47PF 5% BVR=60V DO-7 Q=200-MIN	28480	0122-0164
A6A1CR4	0122-0164	7		DIODE-VVC 47PF 5% BVR=60V DO-7 Q=200-MIN	28480	0122-0164
A6A1CR5-CR7				NOT ASSIGNED		
A6A1CR8	1901-0050	3		DIODE-SWITCHING 80V 200MA 2NS DO-35	28480	1901-0050
A6A1CR9	1901-0050	3		DIODE-SWITCHING 80V 200MA 2NS DO-35	28480	1901-0050
A6A1CR10	1901-0050	3		DIODE-SWITCHING 80V 200MA 2NS DO-35	28480	1901-0050
A6A1E1	9170-0029	3	11	CORE-SHIELDING BEAD	28480	9170-0029
A6A1FL1	9135-0214	4	102	FILTER-HIGH PASS PIN STYLE-TERMS	28480	9135-0214
A6A1FL2	9135-0214	4		FILTER-HIGH PASS PIN STYLE-TERMS	28480	9135-0214
A6A1FL3	9135-0214	4		FILTER-HIGH PASS PIN STYLE-TERMS	28480	9135-0214
A6A1FL4	9135-0214	4		FILTER-HIGH PASS PIN STYLE-TERMS	28480	9135-0214
A6A1FL5	9135-0214	4		FILTER-HIGH PASS PIN STYLE-TERMS	28480	9135-0214
A6A1FL6	9135-0214	4		FILTER-HIGH PASS PIN STYLE-TERMS	28480	9135-0214
A6A1FL7	9135-0214	4		FILTER-HIGH PASS PIN STYLE-TERMS	28480	9135-0214
A6A1FL8	9135-0214	4		FILTER-HIGH PASS PIN STYLE-TERMS	28480	9135-0214
A6A1FL9	9135-0214	4		FILTER-HIGH PASS PIN STYLE-TERMS	28480	9135-0214
A6A1FL10	9135-0214	4		FILTER-HIGH PASS PIN STYLE-TERMS	28480	9135-0214
A6A1FL11	9135-0214	4		FILTER-HIGH PASS PIN STYLE-TERMS	28480	9135-0214
A6A1FL12	9135-0214	4		FILTER-HIGH PASS PIN STYLE-TERMS	28480	9135-0214
A6A1FL13	9135-0214	4		FILTER-HIGH PASS PIN STYLE-TERMS	28480	9135-0214
A6A1J1	1251-8248	8	3	CONN-POST TYPE .100-PIN-SPCG 26-CONT	28480	1251-8248
	1251-5595	2		POLARIZING KEY-POST CONN	28480	1251-5595
A6A1J2	1250-2090	4	47	CONNECTOR-RF SMC M SGL-HOLE-RR 50-OHM	28480	1250-2090
	08642-20081	7		ELSTM CONN SMC	28480	08642-20081
A6A1J3	1250-2090	4		CONNECTOR-RF SMC M SGL-HOLE-RR 50-OHM	28480	1250-2090
	08642-20081	7		ELSTM CONN SMC	28480	08642-20081
A6A1J4	1250-2090	4		CONNECTOR-RF SMC M SGL-HOLE-RR 50-OHM	28480	1250-2090
	08642-20081	7		ELSTM CONN SMC	28480	08642-20081
A6A1J5	1251-5621	5	2	CONNECTOR 12-PIN F POST TYPE	28480	1251-5621
A6A1K1				NOT ASSIGNED		
A6A1K2	0490-0916	6		RELAY-REED 1A 500MA 100VDC 5VDC-COIL	28480	0490-0916
A6A1K3	0490-1423	2	1	RELAY-REED 1C 250MA 28VDC 5VDC-COIL 3VA	28480	0490-1423
A6A1L1	9140-1087	2	99	INDUCTOR-FIXED 120-1300 HZ	28480	9140-1087
A6A1L2	08642-80006	2	1	INDUCTOR AY 45NH	28480	08642-80006
A6A1L3	9140-0096	1	1	INDUCTOR RF-CH-MLD 1UH 10% .166DX.385LG	28480	9140-0096
A6A1L4	9100-2250	9	2	INDUCTOR RF-CH-MLD 180NH 10% .105DX.26LG	28480	9100-2250
A6A1L5				NOT ASSIGNED		

See introduction to this section for ordering information.

\* Indicates factory selected value



Table 6-2. Replaceable Parts

Reference Designation	HP Part Number	C D	Qty	Description	Mfr Code	Mfr Part Number
A6A1L6				NOT ASSIGNED		
A6A1L7	9100-1627	2	2	INDUCTOR RF-CH-MLD 39UH 5% .166DX.385LG	28480	9100-1627
A6A1L8	9140-1087	2		INDUCTOR-FIXED 120-1300 HZ	28480	9140-1087
A6A1L9	9140-1087	2		INDUCTOR-FIXED 120-1300 HZ	28480	9140-1087
A6A1L10	9100-2250	9		INDUCTOR RF-CH-MLD 150NH 10% .105DX.26LG	28480	9100-2250
A6A1MP1	0410-1507	5	1	COMPONENT-CRYSTAL COMPONENT OVEN, SET	28480	0410-1507
A6A1MP2	0340-0840	8		INSULATOR SLBL-LAC-CMPD	28480	0340-0840
A6A1Q1	1854-0810	2	13	TRANSISTOR NPN SI PD=625MW FT=200MHZ	28480	1854-0810
A6A1Q2	1853-0459	3		TRANSISTOR PNP SI PD=625MW FT=200MHZ	28480	1853-0459
A6A1Q3	1855-0235	7	14	TRANSISTOR J-FET N-CHAN D-MODE TO-52 SI	28480	1855-0235
A6A1Q4	1855-0235	7		TRANSISTOR J-FET N-CHAN D-MODE TO-52 SI	28480	1855-0235
A6A1Q5				NOT ASSIGNED		
A6A1Q6	1854-0345	8	10	TRANSISTOR NPN 2N5179 SI TO-72 PD=200MW	04713	2N5179
A6A1Q7	1854-0345	8		TRANSISTOR NPN 2N5179 SI TO-72 PD=200MW	04713	2N5179
A6A1Q8				NOT ASSIGNED		
A6A1Q9	1855-0420	2	6	TRANSISTOR J-FET 2N4391 N-CHAN D-MODE	01295	2N4391
A6A1Q10	1854-0813	5	7	TRANSISTOR NPN 2N3501S SI TO-39 PD=1W	28480	1854-0813
A6A1Q11	1854-0474	4	5	TRANSISTOR NPN SI PD=310MW FT=100MHZ	04713	2N5551
A6A1Q12	1854-0474	4		TRANSISTOR NPN SI PD=310MW FT=100MHZ	04713	2N5551
A6A1Q13	1854-0813	5		TRANSISTOR NPN 2N3501S SI TO-39 PD=1W	28480	1854-0813
A6A1Q14				NOT SEPARATELY REPLACEABLE P/O FM FET KIT		
A6A1Q15	1200-0172	4	1	INSULATOR-XSTR DAP-GL	28480	1200-0172
	1853-0405	9	4	TRANSISTOR PNP SI PD=300MW FT=850MHZ	04713	2N4209
A6A1R1	0698-7260	7		RESISTOR 10K 1% .05W F TC=0+-100	24546	C3-1/8-T0-1002-F
A6A1R2	0698-7236	7		RESISTOR 1K 1% .05W F TC=0+-100	24546	C3-1/8-T0-1001-F
A6A1R3	0698-7273	2		RESISTOR 34.8K 1% .05W F TC=0+-100	24546	C3-1/8-T0-3482-F
A6A1R4	0757-0338	2	2	RESISTOR 30.1 1% .125W F TC=0+-100	24546	C4-1/8-T0-30R1-F
A6A1R5	0757-0338	2	2	RESISTOR 30.1 1% .125W F TC=0+-100	24546	C4-1/8-T0-30R1-F
A6A1R6	0698-7224	3	6	RESISTOR 316 1% .05W F TC=0+-100	24546	C3-1/8-T0-316R-F
A6A1R7	0698-7224	3		RESISTOR 316 1% .05W F TC=0+-100	24546	C3-1/8-T0-316R-F
A6A1R8	0757-0280	3		RESISTOR 1K 1% .125W F TC=0+-100	24546	C4-1/8-T0-1001-F
A6A1R9				NOT ASSIGNED		
A6A1R10	0698-0084	9		RESISTOR 2.15K 1% .125W F TC=0+-100	24546	C4-1/8-T0-2151-F
A6A1R11	0698-3404	3	1	RESISTOR 383 1% .5W F TC=0+-100	28480	0698-3404
A6A1R12				NOT ASSIGNED		
A6A1R13	0698-7213	0	3	RESISTOR 110 1% .05W F TC=0+-100	24546	C3-1/8-T0-110R-F
A6A1R14				NOT ASSIGNED		
A6A1R15	0698-7188	8		RESISTOR 10 1% .05W F TC=0+-100	24546	C3-1/8-T0-10R-F
A6A1R16	0698-7243	6		RESISTOR 1.96K 1% .05W F TC=0+-100	24546	C3-1/8-T0-1961-F
A6A1R17	0698-7208	3	4	RESISTOR 68.1 1% .05W F TC=0+-100	24546	C3-1/8-T0-68R1-F
A6A1R18	0698-7243	6		RESISTOR 1.96K 1% .05W F TC=0+-100	24546	C3-1/8-T0-1961-F
A6A1R19				NOT ASSIGNED		
A6A1R20	0757-0419	0	20	RESISTOR 681 1% .125W F TC=0+-100	24546	C4-1/8-T0-681R-F
A6A1R21	0757-0416	7	8	RESISTOR 511 1% .125W F TC=0+-100	24546	C4-1/8-T0-511R-F
A6A1R22				NOT ASSIGNED		
A6A1R23	0698-7245	8		RESISTOR 2.37K 1% .05W F TC=0+-100	24546	C3-1/8-T0-2371-F
A6A1R24	0698-7229	8	23	RESISTOR 511 1% .05W F TC=0+-100	24546	C3-1/8-T0-511R-F
A6A1R25	0698-7253	8		RESISTOR 5.11K 1% .05W F TC=0+-100	24546	C3-1/8-T0-5111-F
A6A1R26	0698-7250	5	14	RESISTOR 3.83K 1% .05W F TC=0+-100	24546	C3-1/8-T0-3831-F
A6A1R27	0698-7277	6	6	RESISTOR 51.1K 1% .05W F TC=0+-100	24546	C3-1/8-T0-5112-F
A6A1R28	0698-7277	6		RESISTOR 51.1K 1% .05W F TC=0+-100	24546	C3-1/8-T0-5112-F
A6A1R29	0698-7246	9		RESISTOR 2.61K 1% .05W F TC=0+-100	24546	C3-1/8-T0-2611-F
A6A1R30	0698-7233	4	3	RESISTOR 750 1% .05W F TC=0+-100	24546	C3-1/8-T0-750R-F
A6A1R31	0698-7245	8		RESISTOR 2.37K 1% .05W F TC=0+-100	24546	C3-1/8-T0-2371-F
A6A1R32	0757-0293	8	2	RESISTOR 1.96K 1% .125W F TC=0+-25	19701	MF4C1/8-T9-1961-F
A6A1R33				NOT ASSIGNED		
A6A1R34	0757-0293	8		RESISTOR 1.96K 1% .125W F TC=0+-25	19701	MF4C1/8-T9-1961-F
A6A1R35	0698-8638	5	1	RESISTOR 3.16K .1% .125W F TC=0+-25	28480	0698-8638
A6A1R36	2100-3154	7	1	RESISTOR-TRMR 1K 10% C SIDE-ADJ 17-TRN	02111	43P102
A6A1R37				NOT ASSIGNED		
A6A1R38	0698-3960	6	1	RESISTOR 1.1M 1% .125W F TC=0+-100	28480	0698-3960
A6A1R39	0698-8959	3	2	RESISTOR 619K 1% .125W F TC=0+-100	28480	0698-8959
A6A1R40	0698-8959	3		RESISTOR 619K 1% .125W F TC=0+-100	28480	0698-8959
A6A1R41	0698-7280	1	8	RESISTOR 68.1K 1% .05W F TC=0+-100	24546	C3-1/8-T0-6812-F
A6A1R42	0698-7283	4	2	RESISTOR 90.9K 1% .05W F TC=0+-100	24546	C3-1/8-T0-9092-F
A6A1R43	0698-8615	8	4	RESISTOR 75K 1% .05W F TC=0+-100	28480	0698-8615
A6A1R44				NOT ASSIGNED		
A6A1R45	0698-3453	2		RESISTOR 196K 1% .125W F TC=0+-100	24546	C4-1/8-T0-1963-F

See introduction to this section for ordering information.

\* Indicates factory selected value

Table 6-2. Replaceable Parts

Reference Designation	HP Part Number	C D	Qty	Description	Mfr Code	Mfr Part Number
A6A1R46	0757-0398	4	1	RESISTOR 75 1% .125W F TC=0+-100	24546	C4-1/8-T0-75R0-F
A6A1R47	0757-0416	7		RESISTOR 511 1% .125W F TC=0+-100	24546	C4-1/8-T0-511R-F
A6A1R48	0698-3154	0	2	RESISTOR 4.22K 1% .125W F TC=0+-100	24546	C4-1/8-T0-4221-F
A6A1R49	2100-3122	9	1	RESISTOR-TRMR 100 10% C SIDE-ADJ 17-TRN	02111	43P101
A6A1R50	0698-6481	2	4	RESISTOR 16.2K 1% .125W F TC=0+-25	28480	0698-6481
A6A1R51	0698-6481	2		RESISTOR 16.2K 1% .125W F TC=0+-25	28480	0698-6481
A6A1R52	0698-6481	2		RESISTOR 16.2K 1% .125W F TC=0+-25	28480	0698-6481
A6A1R53	0698-6481	2		RESISTOR 16.2K 1% .125W F TC=0+-25	28480	0698-6481
A6A1R54	0698-7258	3	3	RESISTOR 8.25K 1% .05W F TC=0+-100	24546	C3-1/8-T0-8251-F
A6A1R55	0698-3409	8	1	RESISTOR 2.37K 1% .5W F TC=0+-100	28480	0698-3409
A6A1R56	0698-3406	5	1	RESISTOR 1.33K 1% .5W F TC=0+-100	28480	0698-3406
A6A1R57	0698-7283	4		RESISTOR 90.9K 1% .05W F TC=0+-100	24546	C3-1/8-T0-9092-F
A6A1R58	0698-7236	7		RESISTOR 1K 1% .05W F TC=0+-100	24546	C3-1/8-T0-1001-F
A6A1R59	0698-7288	9	2	RESISTOR 147K 1% .05W F TC=0+-100	24546	C3-1/8-T0-1473-F
A6A1R60	0698-7268	5	6	RESISTOR 21.5K 1% .05W F TC=0+-100	24546	C3-1/8-T0-2152-F
A6A1R61				NOT ASSIGNED		
A6A1R62	0698-4443	2	1	RESISTOR 4.53K 1% .125W F TC=0+-100	24546	C4-1/8-T0-4531-F
A6A1R63	0698-7265	2	2	RESISTOR 16.2K 1% .05W F TC=0+-100	24546	C3-1/8-T0-1622-F
A6A1R64	0698-8784	2	1	RESISTOR 19.6K 1% .125W F TC=0+-25	28480	0698-8784
A6A1R65	0698-6358	2	1	RESISTOR 100K .1% .125W F TC=0+-25	28480	0698-6358
A6A1R66	2100-3103	6	2	RESISTOR-TRMR 10K 10% C SIDE-ADJ 17-TRN	02111	43P103
A6A1R67	0698-3150	6	3	RESISTOR 2.37K 1% .125W F TC=0+-100	24546	C4-1/8-T0-2371-F
A6A1R68	0757-0317	7		RESISTOR 1.33K 1% .125W F TC=0+-100	24546	C4-1/8-T0-1331-F
A6A1R69	2100-3056	8	1	RESISTOR-TRMR 5K 10% C SIDE-ADJ 17-TRN	02111	43P502
A6A1R70				NOT SEPARATELY REPLACEABLE P/O FM FET KIT		
A6A1R71				NOT SEPARATELY REPLACEABLE P/O FM FET KIT		
A6A1R72	0698-7236	7		RESISTOR 1K 1% .05W F TC=0+-100	24546	C3-1/8-T0-1001-F
A6A1R73				NOT ASSIGNED		
A6A1R74	2100-3103	6		RESISTOR-TRMR 10K 10% C SIDE-ADJ 17-TRN	02111	43P103
A6A1R75				NOT SEPARATELY REPLACEABLE P/O FM FET KIT		
A6A1R76				NOT SEPARATELY REPLACEABLE P/O FM FET KIT		
A6A1R77	0698-7236	7		RESISTOR 1K 1% .05W F TC=0+-100	24546	C3-1/8-T0-1001-F
A6A1R78	0698-7255	0	4	RESISTOR 6.19K 1% .05W F TC=0+-100	24546	C3-1/8-T0-6191-F
A6A1R79	0698-7236	7		RESISTOR 1K 1% .05W F TC=0+-100	24546	C3-1/8-T0-1001-F
A6A1R80	0757-0394	0		RESISTOR 51.1 1% .125W F TC=0+-100	24546	C4-1/8-T0-51R1-F
A6A1R81	0698-7236	7		RESISTOR 1K 1% .05W F TC=0+-100	24546	C3-1/8-T0-1001-F
A6A1R82	0757-0442	9		RESISTOR 10K 1% .125W F TC=0+-100	24546	C4-1/8-T0-1002-F
A6A1R83	0698-7284	5	15	RESISTOR 100K 1% .05W F TC=0+-100	24546	C3-1/8-T0-1003-F
A6A1R84	0698-7284	5		RESISTOR 100K 1% .05W F TC=0+-100	24546	C3-1/8-T0-1003-F
A6A1R85	0757-0465	6		RESISTOR 100K 1% .125W F TC=0+-100	24546	C4-1/8-T0-1003-F
A6A1R86	0757-0441	8	2	RESISTOR 8.25K 1% .125W F TC=0+-100	24546	C4-1/8-T0-8251-F
A6A1R87	0757-0465	6		RESISTOR 100K 1% .125W F TC=0+-100	24546	C4-1/8-T0-1003-F
A6A1R88	0698-3160	8		RESISTOR 31.6K 1% .125W F TC=0+-100	24546	C4-1/8-T0-3162-F
A6A1R89	0757-0470	3		RESISTOR 162K 1% .125W F TC=0+-100	24546	C4-1/8-T0-1623-F
A6A1R90	0757-0403	2	1	RESISTOR 121 1% .125W F TC=0+-100	24546	C4-1/8-T0-121R-F
A6A1R91	0698-7253	8		RESISTOR 5.11K 1% .05W F TC=0+-100	24546	C3-1/8-T0-5111-F
A6A1R92	0698-7243	6		RESISTOR 1.96K 1% .05W F TC=0+-100	24546	C3-1/8-T0-1961-F
A6A1R93				NOT ASSIGNED		
A6A1R94	0698-7260	7		RESISTOR 10K 1% .05W F TC=0+-100	24546	C3-1/8-T0-1002-F
A6A1R95	0698-7253	8		RESISTOR 5.11K 1% .05W F TC=0+-100	24546	C3-1/8-T0-5111-F
A6A1R96	0698-7253	8		RESISTOR 5.11K 1% .05W F TC=0+-100	24546	C3-1/8-T0-5111-F
A6A1R97	0698-7238	9	9	RESISTOR 1.21K 1% .05W F TC=0+-100	24546	C3-1/8-T0-1211-F
A6A1R98	0698-3445	2		RESISTOR 348 1% .125W F TC=0+-100	24546	C4-1/8-T0-348R-F
A6A1S1	3101-2172	0	1	SWITCH-TGL DIP-RKR-ASSY SPOT .05A 30VDC	28480	3101-2172
A6A1TP1	0360-0535	0		TERMINAL TEST POINT PCB	00000	ORDER BY DESCRIPTION
A6A1TP2	0360-0535	0		TERMINAL TEST POINT PCB	00000	ORDER BY DESCRIPTION
A6A1TP3	0360-0535	0		TERMINAL TEST POINT PCB	00000	ORDER BY DESCRIPTION
A6A1TP4	0360-0535	0		TERMINAL TEST POINT PCB	00000	ORDER BY DESCRIPTION
A6A1TP5	0360-0535	0		TERMINAL TEST POINT PCB	00000	ORDER BY DESCRIPTION
A6A1TP6	0360-0535	0		TERMINAL TEST POINT PCB	00000	ORDER BY DESCRIPTION
A6A1TP7	0360-0535	0		TERMINAL TEST POINT PCB	00000	ORDER BY DESCRIPTION
A6A1TP8	0360-0535	0		TERMINAL TEST POINT PCB	00000	ORDER BY DESCRIPTION

See introduction to this section for ordering information.

\* Indicates factory selected value

Table 6-2. Replaceable Parts

Reference Designation	HP Part Number	C D	Qty	Description	Mfr Code	Mfr Part Number
A6A1U1	1820-1112	8		IC FF TTL LS D-TYPE POS-EDGE-TRIG	01295	SN74LS74AN
A6A1U2	1820-1112	8		IC FF TTL LS D-TYPE POS-EDGE-TRIG	01295	SN74LS74AN
A6A1U3				NOT ASSIGNED		
A6A1U4	1820-1197	9		IC GATE TTL LS NAND QUAD 2-INP	01295	SN74LS00N
A6A1U5	1820-0429	8	1	IC V RGLTR TO-39	18324	LM309H
A6A1U6	1826-0026	3	2	IC COMPARATOR PRCN TO-99 PKG	01295	LM311L
A6A1U7	1826-0716	8	5	IC OP AMP LOW-NOISE DUAL 8-DIP-C PKG	18324	NE5532AFE
A6A1U8	1826-1048	1		IC OP AMP PRCN 8-DIP-C PKG	06655	0P-07CZ
A6A1U9	1826-0783	9	7	IC OP AMP LOW-NOISE 8-DIP-C PKG	52063	XR5534ACN
A6A1U10				NOT ASSIGNED		
A6A1U11	1820-0535	7	3	IC DRVR TTL AND DUAL 2-INP	01295	SN75451BP
A6A1U12	1826-0920	6		ANALOG SWITCH DPDT 14 -CBRZ/SDR	28480	1826-0920
A6A1U13	1826-1049	2	1	IC OP AMP PRCN 8-DIP-C PKG	28480	1826-1049
A6A1U14	1826-0920	6		ANALOG SWITCH DPDT 14 -CBRZ/SDR	28480	1826-0920
A6A1U15	1826-0716	8		IC OP AMP LOW-NOISE DUAL 8-DIP-C PKG	18324	NE5532AFE
A6A1U16	1820-1416	5		IC SCHMITT-TRIG TTL LS INV HEX 1-INP	01295	SN74LS14N
A6A1U17	1820-1433	6	13	IC SHF-RGTR TTL LS R-S SERIAL-IN PRL-OUT	01295	SN74LS164N
A6A1U18	1820-1858	9		IC FF TTL LS D-TYPE OCTL	01295	SN74LS377N
A6A1U19	1820-1212	9	9	IC FF TTL LS J-K NEG-EDGE-TRIG	01295	SN74LS112AN
A6A1U20	1826-0138	8	1	IC COMPARATOR GP QUAD 14-DIP-P PKG	01295	LM339N
A6A1U21	1826-0920	6		ANALOG SWITCH DPDT 14 -CBRZ/SDR	28480	1826-0920
A6A1U22	1820-1547	3	1	IC MULTIPLXR 8-CHAN-ANLG 16-DIP-C PKG	04713	MC14051BCL
A6A1U23	1826-0372	2	3	IC MISC 8-DIP-P PKG	28480	1826-0372
A6A1VR1	1902-0692	1	3	DIODE-ZNR 6.3V 1% DO-7 PD=.4W TC=+.001%	28480	1902-0692
	08642-80016	4	1	FM FET KIT	28480	08642-80016

See introduction to this section for ordering information.

\* Indicates factory selected value



Table 6-2. Replaceable Parts

Reference Designation	HP Part Number	C D	Qty	Description	Mfr Code	Mfr Part Number
<b>A6A2</b>	08642-60102	7	1	COUNTER/TIMEBASE ASSEMBLY	28480	08642-60102
A6A2C1	0160-4832	4		CAPACITOR-FXD .01UF +-10% 100VDC CER	28480	0160-4832
A6A2C2	0160-4832	4		CAPACITOR-FXD .01UF 10% 100VDC CER	28480	0160-4832
A6A2C3	0160-4787	8		CAPACITOR-FXD 22PF + % 100VDC CER 0+-30	28480	0160-4787
A6A2C4	0160-4832	4		CAPACITOR-FXD .01UF +-10% 100VDC CER	28480	0160-4832
A6A2C5	0160-4835	7		CAPACITOR-FXD .1UF +-10% 50VDC CER	28480	0160-4835
A6A2C6	0180-2815	1	1	CAPACITOR-FXD 100UF+-20% 10VDC TA	28480	0180-2815
A6A2C7	0160-0576	5		CAPACITOR-FXD .1UF +-20% 50VDC CER	28480	0160-0576
A6A2C8	0160-4832	4		CAPACITOR-FXD .01UF +-10% 100VDC CER	28480	0160-4832
A6A2C9	0160-3879	7		CAPACITOR-FXD .01UF +-20% 100VDC CER	28480	0160-3879
A6A2C10	0160-4832	4		CAPACITOR-FXD .01UF +-10% 100VDC CER	28480	0160-4832
A6A2C11	0160-4832	4		CAPACITOR-FXD .01UF +-10% 100VDC CER	28480	0160-4832
A6A2C12	0160-4803	9		CAPACITOR-FXD 88PF +-5% 100VDC CER 0+-30	28480	0160-4803
A6A2C13	0160-4793	6	1	CAPACITOR-FXD 6.8PF +- .5PF 100VDC CER	28480	0160-4793
A6A2C14	0160-4832	4		CAPACITOR-FXD .01UF +-10% 100VDC CER	28480	0160-4832
A6A2C15	0121-0445	5	1	CAPACITOR-V TRMR-CER 4.5-20PF 160V	28480	0121-0445
A6A2C16	0160-4832	4		CAPACITOR-FXD .01UF +-10% 100VDC CER	28480	0160-4832
A6A2C17	0160-4832	4		CAPACITOR-FXD .01UF +-10% 100VDC CER	28480	0160-4832
A6A2C18	0160-0576	5		CAPACITOR-FXD .1UF +-20% 50VDC CER	28480	0160-0576
A6A2C19	0160-4791	4	4	CAPACITOR-FXD 10PF +-5% 100VDC CER 0+-30	28480	0160-4791
A6A2C20	0160-4835	7		CAPACITOR-FXD .1UF +-1% 50VDC CER	28480	0160-4835
A6A2C21	0160-4835	7		CAPACITOR-FXD .1UF +-10% 50VDC CER	28480	0160-4835
A6A2C22	0160-4835	7		CAPACITOR-FXD .1UF +-10% 50VDC CER	28480	0160-4835
A6A2C23	0160-3879	7		CAPACITOR-FXD .01UF +-20% 100VDC CER	28480	0160-3879
A6A2C24	0160-4832	4		CAPACITOR-FXD .01UF +-10% 100VDC CER	28480	0160-4832
A6A2C25	0160-4787	8		CAPACITOR-FXD 22PF +-5% 100VDC CER 0+-30	28480	0160-4787
A6A2C26	0160-4768	5	10	CAPACITOR-FXD 470PF +-5% 100VDC CER	28480	0160-4768
A6A2C27	0160-4787	8		CAPACITOR-FXD 22PF +-5% 100VDC CER 0+-30	28480	0160-4787
A6A2C28	0160-4768	5		CAPACITOR-FXD 470PF +-5% 100VDC CER	28480	0160-4768
A6A2C29	0160-4787	8		CAPACITOR-FXD 22PF +-5% 100VDC CER 0+-30	28480	0160-4787
A6A2C30	0160-4768	5		CAPACITOR-FXD 470PF +-5% 100VDC CER	28480	0160-4768
A6A2C31	0160-4787	8		CAPACITOR-FXD 22PF +-5% 100VDC CER 0+-30	28480	0160-4787
A6A2C32	0160-3879	7		CAPACITOR-FXD .01UF +-20% 100VDC CER	28480	0160-3879
A6A2C33	0160-3879	7		CAPACITOR-FXD .01UF +-20% 100VDC CER	28480	0160-3879
A6A2C34	0160-3879	7		CAPACITOR-FXD .01UF +-20% 100VDC CER	28480	0160-3879
A6A2C35	0160-0576	5		CAPACITOR-FXD .1UF +-20% 50VDC CER	28480	0160-0576
A6A2C36	0160-4801	7	15	CAPACITOR-FXD 100PF +-5% 100VDC CER	28480	0160-4801
A6A2C37	0160-3879	7		CAPACITOR-FXD .01UF +-20% 100VDC CER	28480	0160-3879
A6A2C38	0160-4832	4		CAPACITOR-FXD .01UF +-10% 100VDC CER	28480	0160-4832
A6A2C39	0160-4835	7		CAPACITOR-FXD .1UF +-10% 50VDC CER	28480	0160-4835
A6A2C40	0160-4832	4		CAPACITOR-FXD .01UF +-10% 100VDC CER	28480	0160-4832
A6A2C41	0160-4832	4		CAPACITOR-FXD .01UF +-10% 100VDC CER	28480	0160-4832
A6A2C42	0160-4832	4		CAPACITOR-FXD .01UF +-10% 100VDC CER	28480	0160-4832
A6A2C43	0160-4832	4		CAPACITOR-FXD .01UF +-10% 100VDC CER	28480	0160-4832
A6A2C44	0160-4832	4		CAPACITOR-FXD .01UF +-10% 100VDC CER	28480	0160-4832
A6A2C45	0160-4832	4		CAPACITOR-FXD .01UF +-10% 100VDC CER	28480	0160-4832
A6A2C46	0160-4791	4		CAPACITOR-FXD 10PF +-5% 100VDC CER 0+-30	28480	0160-4791
A6A2C47	0160-4574	1	2	CAPACITOR-FXD 1000PF +-10% 100VDC CER	28480	0160-4574
A6A2C48	0160-4766	3	7	CAPACITOR-FXD 30PF +-5% 200VDC CER 0+-30	28480	0160-4766
A6A2C49	0160-3874	2		CAPACITOR-FXD 10PF +- .5PF 200VDC CER	28480	0160-3874
A6A2C50	0160-3878	6		CAPACITOR-FXD 1000PF +-20% 100VDC CER	28480	0160-3878
A6A2C51	0160-0576	5		CAPACITOR-FXD .1UF +-20% 50VDC CER	28480	0160-0576
A6A2C52	0160-0576	5		CAPACITOR-FXD .1UF +-20% 50VDC CER	28480	0160-0576
A6A2C53	0160-0576	5		CAPACITOR-FXD .1UF +-20% 50VDC CER	28480	0160-0576
A6A2C54	0160-0576	5		CAPACITOR-FXD .1UF +-20% 50VDC CER	28480	0160-0576
A6A2C55	0160-0576	5		CAPACITOR-FXD .1UF +-20% 50VDC CER	28480	0160-0576
A6A2C56	0160-0576	5		CAPACITOR-FXD .1UF +-20% 50VDC CER	28480	0160-0576
A6A2C57				NOT ASSIGNED		
A6A2C58	0180-2618	2		CAPACITOR-FXD 33UF+-10% 10VDC TA	25088	D33GS1B10K
A6A2C59	0180-2618	2		CAPACITOR-FXD 33UF+-10% 10VDC TA	25088	D33GS1B10K
A6A2C60	0160-0576	5		CAPACITOR-FXD .1UF +-20% 50VDC CER	28480	0160-0576
A6A2C61	0160-0576	5		CAPACITOR-FXD .1UF +-20% 50VDC CER	28480	0160-0576
A6A2C62	0160-0576	5		CAPACITOR-FXD .1UF +-20% 50VDC CER	28480	0160-0576
A6A2C63	0160-0576	5		CAPACITOR-FXD .1UF +-20% 50VDC CER	28480	0160-0576
A6A2C64	0160-0576	5		CAPACITOR-FXD .1UF +-20% 50VDC CER	28480	0160-0576
A6A2C65	0160-0576	5		CAPACITOR-FXD .1UF +-20% 50VDC CER	28480	0160-0576

See introduction to this section for ordering information.

\* Indicates factory selected value

Table 6-2. Replaceable Parts

Reference Designation	HP Part Number	C D	Qty	Description	Mfr Code	Mfr Part Number
A6A2C66	0160-0576	5		CAPACITOR-FXD .1UF +-20% 50VDC CER	28480	0160-0576
A6A2C67	0160-0576	5		CAPACITOR-FXD .1UF +-20% 50VDC CER	28480	0160-0576
A6A2C68	0160-0576	5		CAPACITOR-FXD .1UF +-20% 50VDC CER	28480	0160-0576
A6A2C69	0160-0576	5		CAPACITOR-FXD .1UF +-20% 50VDC CER	28480	0160-0576
A6A2C70	0160-0576	5		CAPACITOR-FXD .1UF +-20% 50VDC CER	28480	0160-0576
A6A2C71	0160-0576	5		CAPACITOR-FXD .1UF +-20% 50VDC CER	28480	0160-0576
A6A2C72	0160-0576	5		CAPACITOR-FXD .1UF +-20% 50VDC CER	28480	0160-0576
A6A2C73	0160-0576	5		CAPACITOR-FXD .1UF +-20% 50VDC CER	28480	0160-0576
A6A2C74	0160-0576	5		CAPACITOR-FXD .1UF +-20% 50VDC CER	28480	0160-0576
A6A2C75	0180-2661	5		CAPACITOR-FXD 1UF+-10% 50VDC TA	25088	D1R0GS1A50K
A6A2C76	0160-4030	4		CAPACITOR-FXD 820PF +-5% 100VDC CER	28480	0160-4030
A6A2C77	0160-4030	4		CAPACITOR-FXD 820PF +-5% 100VDC CER	28480	0160-4030
A6A2C78	0160-4030	4		CAPACITOR-FXD 820PF +-5% 100VDC CER	28480	0160-4030
A6A2C79	0160-3878	6		CAPACITOR-FXD 1000PF +-20% 100VDC CER	28480	0160-3878
A6A2C80	0160-4835	7		CAPACITOR-FXD .1UF +-10% 50VDC CER	28480	0160-4835
A6A2C81	0160-3879	7		CAPACITOR-FXD .01UF +-20% 100VDC CER	28480	0160-3879
A6A2C82	0160-3879	7		CAPACITOR-FXD .01UF +-20% 100VDC CER	28480	0160-3879
A6A2C83	0160-4801	7		CAPACITOR-FXD 100PF +-5% 100VDC CER	28480	0160-4801
A6A2C84	0180-0116	1		CAPACITOR-FXD 6.8UF+-10% 35VDC TA	56289	150D685X9035B2
A6A2C85	0160-4822	9		CAPACITOR-FXD 1000PF +-5% 100VDC CER	28480	0160-4822
A6A2C86	0160-4835	7		CAPACITOR-FXD .1UF +-10% 50VDC CER	28480	0160-4835
A6A2C87	0160-4832	4		CAPACITOR-FXD .01UF +-10% 100VDC CER	28480	0160-4832
A6A2C88	0180-0491	5		CAPACITOR-FXD 10UF+-20% 25VDC TA	28480	0180-0491
A6A2C89	0180-0491	5		CAPACITOR-FXD 10UF+-20% 25VDC TA	28480	0180-0491
A6A2C90	0160-4835	7		CAPACITOR-FXD .1UF +-10% 50VDC CER	28480	0160-4835
A6A2C91	0160-4835	7		CAPACITOR-FXD .1UF +-10% 50VDC CER	28480	0160-4835
A6A2C92	0160-0576	5		CAPACITOR-FXD .1UF +-20% 50VDC CER	28480	0160-0576
A6A2C93	0160-0576	5		CAPACITOR-FXD .1UF +-20% 50VDC CER	28480	0160-0576
A6A2C94	0180-2661	5		CAPACITOR-FXD 1UF+-10% 50VDC TA	25088	D1R0GS1A50K
A6A2C95	0180-2618	2		CAPACITOR-FXD 33UF+-10% 10VDC TA	25088	D33GS1B10K
A6A2C96	0180-0491	5		CAPACITOR-FXD 10UF+-20% 25VDC TA	28480	0180-0491
A6A2C97	0160-4835	7		CAPACITOR-FXD .1UF +-10% 50VDC CER	28480	0160-4835
A6A2C98	0160-0576	5		CAPACITOR-FXD .1UF +-20% 50VDC CER	28480	0160-0576
2427A TO 2701A A6A2C99				NOT ASSIGNED		
2714A AND ABOVE A6A2C99	0160-5939	4		CAPACITOR-FXD 100PF +-5% 100VDC CER	28480	0160-5939
A6A2CR1	1901-0539	3		DIODE-SCHOTTKY SM SIG	28480	1901-0539
A6A2CR2	1906-0098	9	12	DIODE-MATCHED 1V	28480	1906-0098
A6A2CR3	1906-0098	9		DIODE-MATCHED 1V	28480	1906-0098
A6A2CR4	1906-0098	9		DIODE-MATCHED 1V	28480	1906-0098
A6A2CR5	1906-0098	9		DIODE-MATCHED 1V	28480	1906-0098
A6A2CR6	1901-0028	5	12	DIODE-PWR RECT 400V 750MA DO-29	28480	1901-0028
A6A2CR7	1901-0050	3		DIODE-SWITCHING 80V 200MA 2NS DO-35	28480	1901-0050
A6A2CR8	0122-0161	4		DIODE-VVC 2.15PF 7% BVR=30V	28480	0122-0161
A6A2CR9	1901-0028	5		DIODE-PWR RECT 400V 750MA DO-29	28480	1901-0028
A6A2CR10	1901-0539	3		DIODE-SM SIG SCHOTTKY	28480	1901-0539
A6A2CR11	1901-0539	3		DIODE-SM SIG SCHOTTKY	28480	1901-0539
A6A2FL1	9135-0214	4		FILTER-HIGH PASS PIN STYLE-TERMS	28480	9135-0214
A6A2FL2	9135-0214	4		FILTER-HIGH PASS PIN STYLE-TERMS	28480	9135-0214
A6A2FL3	9135-0214	4		FILTER-HIGH PASS PIN STYLE-TERMS	28480	9135-0214
A6A2FL4	9135-0214	4		FILTER-HIGH PASS PIN STYLE-TERMS	28480	9135-0214
A6A2FL5	9135-0214	4		FILTER-HIGH PASS PIN STYLE-TERMS	28480	9135-0214
A6A2FL6	9135-0214	4		FILTER-HIGH PASS PIN STYLE-TERMS	28480	9135-0214
A6A2J1	1251-8823	5	2	CONN-POST TYPE .100-PIN-SPCG 14-CONT	28480	1251-8823
	1251-5595	2		POLARIZING KEY-POST CONN	28480	1251-5595
A6A2J2	1251-5621	5		CONNECTOR 12-PIN F POST TYPE	28480	1251-5621
A6A2J3	1250-2090	4		CONNECTOR-RF SMC M SGL-HOLE-RR 50-OHM	28480	1250-2090
	08642-20081	7		ELSTMR COND SMC	28480	08642-20081
A6A2J4	1250-2090	4		CONNECTOR-RF SMC M SGL-HOLE-RR 50-OHM	28480	1250-2090
	08642-20081	7		ELSTMR COND SMC	28480	08642-20081
A6A2J5	1250-2090	4		CONNECTOR-RF SMC M SGL-HOLE-RR 50-OHM	28480	1250-2090
	08642-20081	7		ELSTMR COND SMC	28480	08642-20081
A6A2J6	1250-2090	4		CONNECTOR-RF SMC M SGL-HOLE-RR 50-OHM	28480	1250-2090
	08642-20081	7		ELSTMR COND SMC	28480	08642-20081

See introduction to this section for ordering information.

\* Indicates factory selected value

Table 6-2. Replaceable Parts

Reference Designation	HP Part Number	C D	Qty	Description	Mfr Code	Mfr Part Number
A6A2J7	1250-2090	4		CONNECTOR-RF SMC M SGL-HOLE-RR 50-OHM	28480	1250-2090
	08642-20081	7		ELSTMR COND SMC	28480	08642-20081
A6A2J8	1250-2090	4		CONNECTOR-RF SMC M SGL-HOLE-RR 50-OHM	28480	1250-2090
	08642-20078	2	5	ELSTMR CON SMC D	28480	08642-20078
A6A2J9	1250-2090	4		CONNECTOR-RF SMC M SGL-HOLE-RR 50-OHM	28480	1250-2090
	08642-20078	2		ELSTMR CON SMC D	28480	08642-20078
A6A2L1	9100-3919	9	1	INDUCTOR RF-CH-MLD 130NH 5% .166DX.385LG	28480	9100-3919
A6A2L2	9135-0069	7	1	INDUCTOR RF-CH-MLD 30NH 5% .102DX.26LG	28480	9135-0069
A6A2L3	9100-2261	2	1	INDUCTOR RF-CH-MLD 2.7UH 10% .105DX.26LG	28480	9100-2261
A6A2L4	9140-1087	2		INDUCTOR-FIXED 120-1300 HZ	28480	9140-1087
A6A2L5	9140-1087	2		INDUCTOR-FIXED 120-1300 HZ	28480	9140-1087
A6A2L6	9140-1087	2		INDUCTOR-FIXED 120-1300 HZ	28480	9140-1087
A6A2L7	9100-2256	5	6	INDUCTOR RF-CH-MLD 560NH 10% .105DX.26LG	28480	9100-2256
A6A2L8	9100-2256	5		INDUCTOR RF-CH-MLD 560NH 10% .105DX.26LG	28480	9100-2256
A6A2L9	9100-2256	5		INDUCTOR RF-CH-MLD 560NH 10% .105DX.26LG	28480	9100-2256
A6A2L10	9100-2256	5		INDUCTOR RF-CH-MLD 560NH 10% .105DX.26LG	28480	9100-2256
A6A2L11	9140-0302	2	1	INDUCTOR RF-CH-MLD 21.9UH 2%	28480	9140-0302
A6A2L12	9140-1087	2		INDUCTOR-FIXED 120-1300 HZ	28480	9140-1087
A6A2L13	9100-2247	4	27	INDUCTOR RF-CH-MLD 100NH 10% .105DX.26LG	28480	9100-2247
2427A TO 2550A A6A2L14 2701A AND ABOVE A6A2L14	9140-1087	2		INDUCTOR-FIXED 120-1300 HZ NOT ASSIGNED	28480	9140-1087
A6A2L15	9140-0142	8	3	INDUCTOR RF-CH-MLD 2.2UH 10% .105DX.26LG	28480	9140-0142
A6A2L16	9100-2817	4	1	INDUCTOR RF-CH-MLD 100NH 5% .105DX.26LG	28480	9100-2817
2427A TO 2550A A6A2L17 2701A AND ABOVE A6A2L17	9140-1087	2		INDUCTOR-FIXED 120-1300 HZ NOT ASSIGNED	28480	9140-1087
A6A2L18	9140-1087	2		INDUCTOR-FIXED 120-1300 HZ	28480	9140-1087
A6A2L19	9140-1087	2		INDUCTOR-FIXED 120-1300 HZ	28480	9140-1087
A6A2L20	9140-1087	2		INDUCTOR-FIXED 120-1300 HZ	28480	9140-1087
A6A2L21	9100-1620	5	6	INDUCTOR RF-CH-MLD 15UH 10% .166DX.385LG	28480	9100-1620
A6A2L22	9140-1087	2		INDUCTOR-FIXED 120-1300 HZ	28480	9140-1087
A6A2L23	9140-1087	2		INDUCTOR-FIXED 120-1300 HZ	28480	9140-1087
A6A2L24	9140-1087	2		INDUCTOR-FIXED 120-1300 HZ	28480	9140-1087
A6A2L25	9140-1087	2		INDUCTOR-FIXED 120-1300 HZ	28480	9140-1087
A6A2L26	9140-1087	2		INDUCTOR-FIXED 120-1300 HZ	28480	9140-1087
A6A2MP1	0340-0840	8		INSULATOR SLBL-LAC-CMPD	28480	0340-0840
A6A2Q1	1853-0459	3		TRANSISTOR PNP SI PD=625MW FT=200MHZ	28480	1853-0459
A6A2Q2	1854-0810	2		TRANSISTOR NPN SI PD=625MW FT=200MHZ	28480	1854-0810
A6A2Q3	1853-0430	0	4	TRANSISTOR PNP 2N4959 SI TO-72 PD=200MW	04713	2N4959
A6A2Q4	1853-0430	0		TRANSISTOR PNP 2N4959 SI TO-72 PD=200MW	04713	2N4959
A6A2Q5	1854-0345	8		TRANSISTOR NPN 2N5179 SI TO-72 PD=200MW	04713	2N5179
A6A2Q6	1853-0430	0		TRANSISTOR PNP 2N4959 SI TO-72 PD=200MW	04713	2N4959
A6A2Q7	1853-0430	0		TRANSISTOR PNP 2N4959 SI TO-72 PD=200MW	04713	2N4959
A6A2Q8	1854-0811	3	1	TRANSISTOR NPN SI PD=625MW FT=100MHZ	28480	1854-0811
A6A2R1	0757-0467	8	1	RESISTOR 121K 1% .125W F TC=0+-100	24546	C4-1/8-T0-1213-F
A6A2R2	0757-0198	2	1	RESISTOR 100 1% .5W F TC=0+-100	28480	0757-0198
A6A2R3	0757-0465	6		RESISTOR 100K 1% .125W F TC=0+-100	24546	C4-1/8-T0-1003-F
A6A2R4	0698-3429	2	1	RESISTOR 19.6 1% .125W F TC=0+-100	03888	PME55-1/8-T0-19R6-F
A6A2R5	0698-3452	1		RESISTOR 147K 1% .125W F TC=0+-100	24546	C4-1/8-T0-1473-F
A6A2R6	0698-3162	0	1	RESISTOR 46.4K 1% .125W F TC=0+-100	24546	C4-1/8-T0-4642-F
A6A2R7	0757-0405	4	2	RESISTOR 162 1% .125W F TC=0+-100	24546	C4-1/8-T0-162R-F
A6A2R8	0757-0442	9		RESISTOR 10K 1% .125W F TC=0+-100	24546	C4-1/8-T0-1002-F
A6A2R9	0757-0428	1	3	RESISTOR 1.62K 1% .125W F TC=0+-100	24546	C4-1/8-T0-1621-F
A6A2R10	0757-0442	9		RESISTOR 10K 1% .125W F TC=0+-100	24546	C4-1/8-T0-1002-F
A6A2R11	2100-3970	5	1	RESISTOR-TRMR 20K 10% C SIDE-ADJ 25-TRN	28480	2100-3970
A6A2R12	0757-0465	6		RESISTOR 100K 1% .125W F TC=0+-100	24546	C4-1/8-T0-1003-F
A6A2R13	0757-0438	3		RESISTOR 5.11K 1% .125W F TC=0+-100	24546	C4-1/8-T0-5111-F
A6A2R14	0757-0465	6		RESISTOR 100K 1% .125W F TC=0+-100	24546	C4-1/8-T0-1003-F
A6A2R15	0698-0083	8	2	RESISTOR 1.96K 1% .125W F TC=0+-100	24546	C4-1/8-T0-1961-F
A6A2R16	0757-0280	3		RESISTOR 1K 1% .125W F TC=0+-100	24546	C4-1/8-T0-1001-F
A6A2R17	0698-3451	0		RESISTOR 133K 1% .125W F TC=0+-100	24546	C4-1/8-T0-1333-F
A6A2R18	0698-3447	4	14	RESISTOR 422 1% .125W F TC=0+-100	24546	C4-1/8-T0-422R-F
A6A2R19	0757-0438	3		RESISTOR 5.11K 1% .125W F TC=0+-100	24546	C4-1/8-T0-5111-F
A6A2R20				NOT ASSIGNED		

See introduction to this section for ordering information.

\* Indicates factory selected value

Table 6-2. Replaceable Parts

Reference Designation	HP Part Number	C D	Qty	Description	Mfr Code	Mfr Part Number
A6A2R21	0757-0394	0		RESISTOR 51.1 1% .125W F TC=0+-100	24546	C4-1/8-T0-51R1-F
A6A2R22				NOT ASSIGNED		
A6A2R23	0698-3152	8	2	RESISTOR 3.48K 1% .125W F TC=0+-100	24546	C4-1/8-T0-3481-F
A6A2R24	0757-0394	0		RESISTOR 51.1 1% .125W F TC=0+-100	24546	C4-1/8-T0-51R1-F
A6A2R25	0757-0280	3		RESISTOR 1K 1% .125W F TC=0+-100	24546	C4-1/8-T0-1001-F
A6A2R26-R31				NOT ASSIGNED		
A6A2R32	0757-0394	0		RESISTOR 51.1 1% .125W F TC=0+-100	24546	C4-1/8-T0-51R1-F
A6A2R33	0757-1094	9	2	RESISTOR 1.47K 1% .125W F TC=0+-100	24546	C4-1/8-T0-1471-F
A6A2R34	0757-0290	5	1	RESISTOR 6.19K 1% .125W F TC=0+-100	19701	MF4C1/8-T0-6191-F
A6A2R35	0757-0438	3		RESISTOR 5.11K 1% .125W F TC=0+-100	24546	C4-1/8-T0-5111-F
A6A2R36	0757-0278	9		RESISTOR 1.78K 1% .125W F TC=0+-100	24546	C4-1/8-T0-1781-F
A6A2R37	0757-0421	4	3	RESISTOR 825 1% .125W F TC=0+-100	24546	C4-1/8-T0-825R-F
A6A2R38	0698-3438	3	3	RESISTOR 147 1% .125W F TC=0+-100	24546	C4-1/8-T0-147R-F
A6A2R39				NOT ASSIGNED		
A6A2R40	0757-0438	3		RESISTOR 5.11K 1% .125W F TC=0+-100	24546	C4-1/8-T0-5111-F
A6A2R41	0757-0280	3		RESISTOR 1K 1% .125W F TC=0+-100	24546	C4-1/8-T0-1001-F
A6A2R42	0757-0279	0	3	RESISTOR 3.16K 1% .125W F TC=0+-100	24546	C4-1/8-T0-3161-F
A6A2R43	0698-3154	0		RESISTOR 4.22K 1% .125W F TC=0+-100	24546	C4-1/8-T0-4221-F
A6A2R44	0698-7219	6	5	RESISTOR 196 1% .05W F TC=0+-100	24546	C3-1/8-T0-196R-F
A6A2R45	0698-7243	6		RESISTOR 1.96K 1% .05W F TC=0+-100	24546	C3-1/8-T0-1961-F
A6A2R46	0698-7243	6		RESISTOR 1.96K 1% .05W F TC=0+-100	24546	C3-1/8-T0-1961-F
A6A2R47-R49				NOT ASSIGNED		
A6A2R50	0698-7229	8		RESISTOR 511 1% .05W F TC=0+-100	24546	C3-1/8-T0-511R-F
A6A2R51	0698-7240	3	4	RESISTOR 1.47K 1% .05W F TC=0+-100	24546	C3-1/8-T0-1471-F
A6A2R52	0698-7205	0		RESISTOR 51.1 1% .05W F TC=0+-100	24546	C3-1/8-T0-51R1-F
A6A2R53	0698-7224	3		RESISTOR 316 1% .05W F TC=0+-100	24546	C3-1/8-T0-316R-F
A6A2R54	0698-7212	9	27	RESISTOR 100 1% .05W F TC=0+-100	24546	C3-1/8-T0-100R-F
A6A2R55	0698-7236	7		RESISTOR 1K 1% .05W F TC=0+-100	24546	C3-1/8-T0-1001-F
A6A2R56	0698-7259	4	5	RESISTOR 9.09K 1% .05W F TC=0+-100	24546	C3-1/8-T0-9091-F
A6A2R57	0698-7259	4		RESISTOR 9.09K 1% .05W F TC=0+-100	24546	C3-1/8-T0-9091-F
A6A2R58	0698-7259	4		RESISTOR 9.09K 1% .05W F TC=0+-100	24546	C3-1/8-T0-9091-F
A6A2R59	0698-7207	2	1	RESISTOR 61.9 1% .05W F TC=0+-100	24546	C4-1/8-T0-61R9-F
A6A2R60	0698-7236	7		RESISTOR 1K 1% .05W F TC=0+-100	24546	C3-1/8-T0-1001-F
A6A2R61	0698-7236	7		RESISTOR 1K 1% .05W F TC=0+-100	24546	C3-1/8-T0-1001-F
A6A2R62	0698-7260	7		RESISTOR 10K 1% .05W F TC=0+-100	24546	C3-1/8-T0-1002-F
A6A2R63	0698-7205	0	49	RESISTOR 51.1 1% .05W F TC=0+-100	24546	C3-1/8-T0-51R1-F
A6A2R64	0698-7239	0	4	RESISTOR 1.33K 1% .05W F TC=0+-100	24546	C3-1/8-T0-1331-F
A6A2R65	0698-7239	0		RESISTOR 1.33K 1% .05W F TC=0+-100	24546	C3-1/8-T0-1331-F
A6A2R66	0698-7203	8	10	RESISTOR 42.2 1% .05W F TC=0+-100	24546	C3-1/8-T0-42R2-F
A6A2R67	0698-7264	1	7	RESISTOR 14.7K 1% .05W F TC=0+-100	24546	C3-1/8-T0-1472-F
A6A2R68	0698-7212	2		RESISTOR 100 1% .05W F TC=0+-100	24546	C3-1/8-T0 100R-F-100R-F
2427A TO 2550A A6A2R69				NOT ASSIGNED		
2701A AND ABOVE A6A2R69	0698-7220	9		RESISTOR 215 1% .05W F TC=0+-100	24546	C4-1/8-T0-215R-F
2427A TO 2550A A6A2R70				NOT ASSIGNED		
2701A AND ABOVE A6A2R70	0698-7220	9		RESISTOR 215 1% .05W F TC=0+-100	24546	C4-1/8-T0-215R-F
A6A2T1	08642-60029	7	1	RF TRANSFORMER	28480	08642-60029
A6A2T2	08662-80013	5	1	TRANSFORMER 12T	28480	08662-80013
A6A2TP1	0360-0535	0		TERMINAL TEST POINT PCB	00000	ORDER BY DESCRIPTION
A6A2TP2	0360-0535	0		TERMINAL TEST POINT PCB	00000	ORDER BY DESCRIPTION
A6A2U1	1820-2691	0	6	IC FF TTL F D-TYPE POS-EDGE-TRIG	07263	74F74PC
A6A2U2	1820-3353	3	1	IC CNTR TTL ALS BIN UP/DOWN SYNCHRO	28480	1820-3353
A6A2U3	1820-1225	4	1	IC FF ECL D-M/S DUAL	04713	MC10231P
A6A2U4	1820-1052	5	3	IC XLTR ECL ECL-TO-TTL QUAD 2-INP	04713	MC10125L
A6A2U5	1820-1278	7	1	IC CNTR TTL LS BIN UP/DOWN SYNCHRO	01295	SN74LS191N
A6A2U6	1820-2506	6	2	IC INV TTL F HEX	07263	74F04PC
A6A2U7	1820-1201	6	1	IC GATE TTL LS AND QUAD 2-INP	01295	SN74LS08N
A6A2U8	1820-1112	8		IC FF TTL LS D-TYPE POS-EDGE-TRIG	01295	SN74LS74AN
A6A2U9	1820-1208	3	1	IC GATE TTL LS OR QUAD 2-INP	01295	SN74LS32N
A6A2U10	1820-1437	0	7	IC MV TTL LS MONOSTBL DUAL	01295	SN74LS221N
A6A2U11	1820-1437	0		IC MV TTL LS MONOSTBL DUAL	01295	SN74LS221N
A6A2U12	1820-2935	5	1	IC PRESCR ECL	28480	1820-2935
A6A2U13	1820-1991	1	3	IC CNTR TTL LS DECD DUAL 4-BIT	01295	SN74LS390N
A6A2U14	1820-2691	0		IC FF TTL F D-TYPE POS-EDGE-TRIG	07263	74F74PC
A6A2U15	1826-0210	7		IC COMPARTOR HS 14-DIP-P PKG	27014	LM361N

See introduction to this section for ordering information.

\* Indicates factory selected value



Table 6-2. Replaceable Parts

Reference Designation	HP Part Number	C D	Qty	Description	Mfr Code	Mfr Part Number
A6A2U16	1820-1197	9	2	IC GATE TTL LS NAND QUAD 2-INP	01295	SN74LS00N
A6A2U17	1820-1251	6		IC CNTR TTL LS DECD ASYNCHRO	01295	SN74LS196N
A6A2U18	1820-1197	9		IC GATE TTL LS NAND QUAD 2-INP	01295	SN74LS00N
A6A2U19	1820-1197	9		IC GATE TTL LS NAND QUAD 2-INP	01295	SN74LS00N
A6A2U20	1820-1197	9		IC GATE TTL LS NAND QUAD 2-INP	01295	SN74LS00N
A6A2U21	1820-2684	1	2	IC GATE TTL F NAND QUAD 2-INP	07263	74F00PC
A6A2U22	1820-1991	1		IC CNTR TTL LS DECD DUAL 4-BIT	01295	SN74LS390N
A6A2U23	1820-1193	5	1	IC CNTR TTL LS BIN ASYNCHRO	01295	SN74LS197N
A6A2U24	1820-1975	1		IC SHF-RGTR TTL LS NEG-EDGE-TRIG PRL-IN	01295	SN74LS165N
A6A2U25	1820-1975	1		IC SHF-RGTR TTL LS NEG-EDGE-TRIG PRL-IN	01295	SN74LS165N
A6A2U26	1820-1975	1	1	IC SHF-RGTR TTL LS NEG-EDGE-TRIG PRL-IN	01295	SN74LS165N
A6A2U27	1820-0765	5		IC CNTR TTL BIN ASYNCHRO NEG-EDGE-TRIG	01295	SN74197N
A6A2U28	1820-2096	9		IC CNTR TTL LS BIN DUAL 4-BIT	01295	SN74LS393N
A6A2U29	1820-2096	9		IC CNTR TTL LS BIN DUAL 4-BIT	01295	SN74LS393N
A6A2U30	1826-0606	5		IC SWITCH ANLG QUAD 16-DIP-C PKG	17856	DG201BK
A6A2U31	1826-0753	3	1	IC OP AMP LOW-BIAS-H-IMPQ QUAD 14-DIP-C	04713	MC34004BL
A6A2U32	1820-1991	1		IC CNTR TTL LS DECD DUAL 4-BIT	01295	SN74LS390N
A6A2U33	1820-0681	4		IC GATE TTL S NAND QUAD 2-INP	01295	SN74S00N
A6A2U34	1820-1052	5		IC XLTR ECL ECL-TO-TTL QUAD 2-INP	04713	MC10125L
A6A2U35	1820-1423	4		IC MV TTL LS MONOSTBL RETRIG DUAL	01295	SN74LS123N
A6A2U36	1820-1416	5	1	IC SCHMITT-TRIG TTL LS INV HEX 1-INP	01295	SN74LS14N
A6A2Y1	0410-1568	8	1	XTAL 44.996 MHZ	28480	0410-1568

See introduction to this section for ordering information.

\* Indicates factory selected value



Table 6-2. Replaceable Parts

Reference Designation	HP Part Number	C D	Qty	Description	Mfr Code	Mfr Part Number
<b>A7</b>						
A7	08642-60894	4	1	SAWR LOOP MODULE	28480	08642-60894
A7	08643-69894	2	1	SAWR LOOP MODULE (RESTORED)	28480	08642-69894
A7MP2	08642-40055	7	4	GASKET FEEDTHRU5	28480	08642-40055
A7MP3	08642-40059	1	2	GASKET FEEDTHRU9	28480	08642-40059
A7MP4	08642-00121	4	1	FOAM-COND SAWR GD	28480	08642-00121
A7MP5	08642-20005	5	1	BASE SAWR PLL	28480	08642-20005
A7MP6	0515-0684	9		SCREW-MACH M4 X 0.7 6MM-LG PAN-HD (ATTACH BOARDS TO BASE)	28480	0515-0684
A7MP7	0515-0381	3		SCREW-MACH M4 X 0.7 10MM-LG PAN-HD (ATTACH COVER TO BASE)	00000	ORDER BY DESCRIPTION
A7MP8	8160-0472	8		RFI ROUND STRIP BE-CU SN-PL .093-IN-OD (SPIRA SHIELD)	28480	8160-0472
A7MP9	08642-00056	4	1	SLIDE-MODULE F2 (FRONT)	28480	08642-00056
A7MP10	0515-1102	8		SCREW-MACH M3 X 0.5 8MM-LG 90-DEG-FLH-HD (ATTACH A7MP9 TO BASE)	28480	0515-1102
A7MP11	08642-00055	3	2	SLIDE-MODUL IR23 (REAR, BOTTOM)	28480	08642-00055
A7MP12	08642-00057	5	2	SLIDE-MODUL OR23 (REAR, TOP)	28480	08642-00057
A7MP13	0515-1103	9	6	SCREW-MACH M3 X 0.5 10MM-LG (ATTACH A7MP11, A7MP12 TO BASE)	28480	0515-1103
A7MP14	08642-80065	3	1	LABEL-SAW 60002	28480	08642-80065
A7MP1	08642-20004	4	1	COVER SAWR LOOP	28480	08642-20004

See introduction to this section for ordering information.

\* Indicates factory selected value



Table 6-2. Replaceable Parts

Reference Designation	HP Part Number	C D	Qty	Description	Mfr Code	Mfr Part Number
2427A TO 2512A A7A1	08642-60103	8	1	SAWR LOOP ASSEMBLY	28480	08642-60103
2513A AND ABOVE A7A1	08642-60203	9	1	SAWR LOOP ASSEMBLY	28480	08642-60203
A7A1C1	0160-5945	2		CAPACITOR-FXD .01UF +-10% 50VDC CER	28480	0160-5945
A7A1C2				NOT ASSIGNED		
A7A1C3	0160-4522	9	2	CAPACITOR-FXD 13PF +-5% 200VDC CER 0+-30	28480	0160-4522
A7A1C4	0160-4832	4		CAPACITOR-FXD .01UF +-10% 100VDC CER	28480	0160-4832
A7A1C5	0160-0571	0	12	CAPACITOR-FXD 470PF +-20% 100VDC CER	28480	0160-0571
A7A1C6	0160-4832	4		CAPACITOR-FXD .01UF +-10% 100VDC CER	28480	0160-4832
A7A1C7	0160-0571	0		CAPACITOR-FXD 470PF +-20% 100VDC CER	28480	0160-0571
A7A1C8	0160-3879	7		CAPACITOR-FXD .01UF +-20% 100VDC CER	28480	0160-3879
A7A1C9	0160-0571	0		CAPACITOR-FXD 470PF +-20% 100VDC CER	28480	0160-0571
A7A1C10	0160-5957	6		CAPACITOR-FXD 47PF +-5% 50VDC CER 0+-30	28480	0160-5957
A7A1C11	0160-3879	7		CAPACITOR-FXD .01UF +-20% 100VDC CER	28480	0160-3879
A7A1C12	0160-3879	7		CAPACITOR-FXD .01UF +-20% 100VDC CER	28480	0160-3879
A7A1C13	0160-3879	7		CAPACITOR-FXD .01UF +-20% 100VDC CER	28480	0160-3879
A7A1C14	0160-2946	7	1	CAPACITOR-FXD 120PF +-1% 500VDC MICA	28480	0160-2946
A7A1C15	0160-0571	0		CAPACITOR-FXD 470PF +-20% 100VDC CER	28480	0160-0571
A7A1C16	0160-0576	5		CAPACITOR-FXD .1UF +-20% 50VDC CER	28480	0160-0576
A7A1C17	0160-3874	2		CAPACITOR-FXD 10PF +- .5PF 200VDC CER	28480	0160-3874
A7A1C18	0160-3874	2		CAPACITOR-FXD 10PF +- .5PF 200VDC CER	28480	0160-3874
A7A1C19	0160-3875	3	10	CAPACITOR-FXD 22PF +-5% 200VDC CER 0+-30	28480	0160-3875
A7A1C20	0160-3879	7		CAPACITOR-FXD .01UF +-20% 100VDC CER	28480	0160-3879
A7A1C21	0160-4833	5	2	CAPACITOR-FXD .022UF +-10% 100VDC CER	28480	0160-4833
A7A1C22	0160-3875	3		CAPACITOR-FXD 22PF +-5% 200VDC CER 0+-30	28480	0160-3875
A7A1C23	0180-2205	3	1	CAPACITOR-FXD .33UF+-10% 35VDC TA	56289	150D334X9035A2
A7A1C24	0160-5714	3	1	CAPACITOR-FXD .68UF +-10% 100VDC CER	28480	0160-5714
A7A1C25	0160-4832	4		CAPACITOR-FXD .01UF +-10% 100VDC CER	28480	0160-4832
A7A1C26	0160-0573	2	9	CAPACITOR-FXD 4700PF +-20% 100VDC CER	28480	0160-0573
A7A1C27	0160-0573	2		CAPACITOR-FXD 4700PF +-20% 100VDC CER	28480	0160-0573
A7A1C28	0160-4387	4	7	CAPACITOR-FXD 47PF +-5% 200VDC CER 0+-30	28480	0160-4387
A7A1C29	0160-4387	4		CAPACITOR-FXD 47PF +-5% 200VDC CER 0+-30	28480	0160-4387
A7A1C30	0160-4832	4		CAPACITOR-FXD .01UF +-10% 100VDC CER	28480	0160-4832
A7A1C31	0160-3879	7		CAPACITOR-FXD .01UF +-20% 100VDC CER	28480	0160-3879
A7A1C32	0160-0576	5		CAPACITOR-FXD .1UF +-20% 50VDC CER	28480	0160-0576
A7A1C33	0160-0576	5		CAPACITOR-FXD .1UF +-20% 50VDC CER	28480	0160-0576
A7A1C34	0160-5945	2		CAPACITOR-FXD .01UF +-10% 50VDC CER	28480	0160-5945
A7A1C35	0180-0553	0	3	CAPACITOR-FXD 22UF+-20% 25VDC TA	28480	0180-0553
A7A1C36	0180-2683	1		CAPACITOR-FXD 4.7UF+-20% 35VDC TA	28480	0180-2683
A7A1C37	0180-0553	0		CAPACITOR-FXD 22UF+-20% 25VDC TA	28480	0180-0553
A7A1C38	0160-4511	6	6	CAPACITOR-FXD 220PF +-5% 200VDC CER	28480	0160-4511
A7A1C39-C100				NOT ASSIGNED		
A7A1C101	0180-0491	5		CAPACITOR-FXD 10UF+-20% 25VDC TA	28480	0180-0491
A7A1C102				NOT ASSIGNED		
A7A1C103	0160-4387	4		CAPACITOR-FXD 47PF +-5% 200VDC CER 0+-30	28480	0160-4387
A7A1C104	0160-5957	6		CAPACITOR-FXD 47PF +-5% 50VDC CER 0+-30	28480	0160-5957
A7A1C105	0160-5957	6		CAPACITOR-FXD 47PF +-5% 50VDC CER 0+-30	28480	0160-5957
A7A1C106	0160-5957	6		CAPACITOR-FXD 47PF +-5% 50VDC CER 0+-30	28480	0160-5957
A7A1C107	0160-3879	7		CAPACITOR-FXD .01UF +-20% 100VDC CER	28480	0160-3879
A7A1C108	0160-4387	4		CAPACITOR-FXD 47PF +-5% 200VDC CER 0+-30	28480	0160-4387
A7A1C109				NOT ASSIGNED		
A7A1C110	0160-3874	2		CAPACITOR-FXD 10PF +- .5PF 200VDC CER	28480	0160-3874
A7A1C111	0160-5957	6		CAPACITOR-FXD 47PF +-5% 50VDC CER 0+-30	28480	0160-5957
A7A1C112	0160-5957	6		CAPACITOR-FXD 47PF +-5% 50VDC CER 0+-30	28480	0160-5957
A7A1C113	0160-5957	6		CAPACITOR-FXD 47PF +-5% 50VDC CER 0+-30	28480	0160-5957
A7A1C114-C116				NOT ASSIGNED		
A7A1C117	0160-3874	2		CAPACITOR-FXD 10PF +- .5PF 200VDC CER	28480	0160-3874
A7A1C118				NOT ASSIGNED		
A7A1C119				NOT ASSIGNED		
A7A1C120	0160-5957	6		CAPACITOR-FXD 47PF +-5% 50VDC CER 0+-30	28480	0160-5957
A7A1C121	0160-5957	6		CAPACITOR-FXD 47PF +-5% 50VDC CER 0+-30	28480	0160-5957
A7A1C122	0160-5957	6		CAPACITOR-FXD 47PF +-5% 50VDC CER 0+-30	28480	0160-5957
A7A1C123	0160-3872	0	9	CAPACITOR-FXD 2.2PF +- .25PF 200VDC CER	28480	0160-3872
A7A1C124	0160-3872	0		CAPACITOR-FXD 2.2PF +- .25PF 200VDC CER	28480	0160-3872
A7A1C125				NOT ASSIGNED		
A7A1C126	0160-3874	2		CAPACITOR-FXD 10PF +- .5PF 200VDC CER	28480	0160-3874
A7A1C127	0160-5947	4		CAPACITOR-FXD 1000PF +-10% 50VDC CER	28480	0160-5947
A7A1C128	0160-0571	0		CAPACITOR-FXD 470PF +-20% 100VDC CER	28480	0160-0571

See introduction to this section for ordering information.

\* Indicates factory selected value

Table 6-2. Replaceable Parts

Reference Designation	HP Part Number	C D	Qty	Description	Mfr Code	Mfr Part Number
A7A1C129	0160-0571	0		CAPACITOR-FXD 470PF +-20% 100VDC CER	28480	0160-0571
A7A1C130	0160-3872	0		CAPACITOR-FXD 2.2PF +- .25PF 200VDC CER	28480	0160-3872
A7A1C131	0160-3872	0		CAPACITOR-FXD 2.2PF +- .25PF 200VDC CER	28480	0160-3872
A7A1C132	0160-0571	0		CAPACITOR-FXD 470PF +-20% 100VDC CER	28480	0160-0571
A7A1C133	0160-0571	0		CAPACITOR-FXD 470PF +-20% 100VDC CER	28480	0160-0571
A7A1C134	0160-3873	1	9	CAPACITOR-FXD 4.7PF +- .5PF 200VDC CER	28480	0160-3873
A7A1C135	0160-0571	0		CAPACITOR-FXD 470PF +-20% 100VDC CER	28480	0160-0571
A7A1C136	0160-5957	6		CAPACITOR-FXD 47PF +-5% 50VDC CER 0+-30	28480	0160-5957
A7A1C137				NOT ASSIGNED		
A7A1C138	0160-0571	0		CAPACITOR-FXD 470PF +-20% 100VDC CER	28480	0160-0571
A7A1C139	0160-0571	0		CAPACITOR-FXD 470PF +-20% 100VDC CER	28480	0160-0571
A7A1C140	0160-5947	4		CAPACITOR-FXD .01UF +-10% 50VDC	28480	0160-5947
A7A1C141	0160-5970	3		CAPACITOR-FXD 3.9PF +- .5PF 50VDC CER	28480	0160-5970
A7A1C142	0160-6212	8		CAPACITOR-FXD 470PF +-5% 50VDC CER	28480	0160-6212
A7A1C143	0160-6212	8		CAPACITOR-FXD 470PF +-5% 50VDC CER	28480	0160-6212
A7A1C144	0160-6212	8		CAPACITOR-FXD 470PF +-5% 50VDC CER	28480	0160-6212
A7A1C145	0160-6212	8		CAPACITOR-FXD 470PF +-5% 50VDC CER	28480	0160-6212
A7A1C146	0160-5971	4		CAPACITOR-FXD 4.7PF +- .5PF 50VDC CER	28480	0160-5971
<b>2427A TO 2512A</b>						
A7A1C147*	0160-4382	9		CAPACITOR-FXD 3.3PF +- .25PF 200VDC CER	28480	0160-4382
A7A1C148*	0160-4618	4		CAPACITOR-FXD 3.9PF +- .25PF 200VDC CER	28480	0160-4618
A7A1C149*	0160-4498	8		CAPACITOR-FXD 5.6PF +- .5PF 200VDC CER	28480	0160-4498
<b>2513A AND ABOVE</b>						
A7A1C147	0160-5969	0		CAPACITOR-FXD 3.3PF +- .5PF 50VDC CER	28480	0160-5969
A7A1C148	0160-5970	3		CAPACITOR-FXD 3.9PF +- .5PF 50VDC CER	28480	0160-5970
A7A1C149	0160-5972	2		CAPACITOR-FXD 5.6PF +- .5PF 50VDC CER	28480	0160-5972
A7A1CR1-CR4				NOT ASSIGNED		
A7A1CR5	1906-0098	9		DIODE-MATCHED 1V	28480	1906-0098
A7A1CR6	1906-0098	9		DIODE-MATCHED 1V	28480	1906-0098
A7A1CR7	1906-0098	9		DIODE-MATCHED 1V	28480	1906-0098
A7A1CR8	1906-0098	9		DIODE-MATCHED 1V	28480	1906-0098
A7A1CR9	1901-0457	4	2	DIODE-STEP RECOVERY	28480	1901-0457
A7A1CR10	1901-0518	8		DIODE-SM SIG SCHOTTKY	28480	1901-0518
A7A1CR11-CR100				NOT ASSIGNED		
A7A1CR101	0122-0161	4		DIODE-VVC 2.15PF 7% BVR=30V	28480	0122-0161
A7A1CR102	0122-0161	4		DIODE-VVC 2.15PF 7% BVR=30V	28480	0122-0161
A7A1CR103				NOT ASSIGNED		
A7A1CR104				NOT ASSIGNED		
A7A1CR105	0122-0161	4		DIODE-VVC 2.15PF 7% BVR=30V	28480	0122-0161
A7A1CR106	0122-0161	4		DIODE-VVC 2.15PF 7% BVR=30V	28480	0122-0161
A7A1CR107				NOT ASSIGNED		
A7A1CR108				NOT ASSIGNED		
A7A1CR109	0122-0161	4		DIODE-VVC 2.15PF 7% BVR=30V .5	04713	BB105B
A7A1CR110	0122-0161	4		DIODE-VVC 2.15PF 7% BVR=30V	04713	BB105B
A7A1FL1	9135-0214	4		FILTER-HIGH PASS PIN STYLE-TERMS	28480	9135-0214
A7A1FL2	9135-0214	4		FILTER-HIGH PASS PIN STYLE-TERMS	28480	9135-0214
A7A1FL3	9135-0214	4		FILTER-HIGH PASS PIN STYLE-TERMS	28480	9135-0214
A7A1FL4	9135-0214	4		FILTER-HIGH PASS PIN STYLE-TERMS	28480	9135-0214
A7A1FL5	9135-0214	4		FILTER-HIGH PASS PIN STYLE-TERMS	28480	9135-0214
A7A1FL6	9135-0214	4		FILTER-HIGH PASS PIN STYLE-TERMS	28480	9135-0214
A7A1FL7	9135-0214	4		FILTER-HIGH PASS PIN STYLE-TERMS	28480	9135-0214
A7A1FL8	9135-0214	4		FILTER-HIGH PASS PIN STYLE-TERMS	28480	9135-0214
A7A1FL9	9135-0214	4		FILTER-HIGH PASS PIN STYLE-TERMS	28480	9135-0214
A7A1FL10	9135-0214	4		FILTER-HIGH PASS PIN STYLE-TERMS	28480	9135-0214
A7A1FL11	9135-0214	4		FILTER-HIGH PASS PIN STYLE-TERMS	28480	9135-0214
A7A1FL12	9135-0214	4		FILTER-HIGH PASS PIN STYLE-TERMS	28480	9135-0214
A7A1FL13	9135-0214	4		FILTER-HIGH PASS PIN STYLE-TERMS	28480	9135-0214
A7A1FL14	9135-0214	4		FILTER-HIGH PASS PIN STYLE-TERMS	28480	9135-0214
A7A1J1	1251-8823	5		CONN-POST TYPE .100-PIN-SPCG 14-CONT	28480	1251-8823
	1251-5595	2		POLARIZING KEY-POST CONN	28480	1251-5595
A7A1J2	1250-2090	4		CONNECTOR-RF SMC M SGL-HOLE-RR 50-OHM	28480	1250-2090
	08642-20081	7		ELSTMR COND SMC	28480	08642-20081
A7A1J3	1250-2090	4		CONNECTOR-RF SMC M SGL-HOLE-RR 50-OHM	28480	1250-2090
	08642-20081	7		ELSTMR COND SMC	28480	08642-20081
A7A1L1	9140-1087	2		INDUCTOR-FIXED 120-1300 HZ	28480	9140-1087
A7A1L2	9100-2254	3	4	INDUCTOR RF-CH-MLD 390NH 10% .105DX.26LG	28480	9100-2254
A7A1L3-L5				NOT ASSIGNED		
A7A1L6	9100-2247	4		INDUCTOR RF-CH-MLD 100NH 10% .105DX.26LG	28480	9100-2247
A7A1L7	9100-1624	9	1	INDUCTOR RF-CH-MLD 30UH 5% .166DX.385LG	28480	9100-1624

See introduction to this section for ordering information.

\* Indicates factory selected value

Table 6-2. Replaceable Parts

Reference Designation	HP Part Number	C D	Qty	Description	Mfr Code	Mfr Part Number
A7A1L8	9140-1087	2		INDUCTOR-FIXED 120-1300 HZ	28480	9140-1087
A7A1L9	9140-1087	2		INDUCTOR-FIXED 120-1300 HZ	28480	9140-1087
A7A1L10	9140-0531	9	8	INDUCTOR RF-CH-MLD 1UH 5% .105DX.26LG	28480	9140-0531
A7A1L11	9140-1087	2		INDUCTOR-FIXED 120-1300 HZ	28480	9140-1087
A7A1L12	9140-0532	0	5	INDUCTOR RF-CH-MLD 1.2UH 5% .105DX.26LG	28480	9140-0532
A7A1L13	9140-0532	0		INDUCTOR RF-CH-MLD 1.2UH 5% .105DX.26LG	28480	9140-0532
A7A1L14	9140-1087	2		INDUCTOR-FIXED 120-1300 HZ	28480	9140-1087
A7A1L15-L100				NOT ASSIGNED		
A7A1L101	9100-2247	4		INDUCTOR RF-CH-MLD 100NH 10% .105DX.26LG	28480	9100-2247
A7A1L102	9140-0532	0		INDUCTOR RF-CH-MLD 1.2UH 5% .105DX.26LG	28480	9140-0532
A7A1L103	9100-2247	4		INDUCTOR RF-CH-MLD 100NH 10% .105DX.26LG	28480	9100-2247
A7A1L104	9100-2247	4		INDUCTOR RF-CH-MLD 100NH 10% .105DX.26LG	28480	9100-2247
A7A1L105	9140-1087	2		INDUCTOR-FIXED 120-1300 HZ	28480	9140-1087
A7A1L106-L108				NOT ASSIGNED		
A7A1L109	9100-2247	4		INDUCTOR RF-CH-MLD 100NH 10% .105DX.26LG	28480	9100-2247
A7A1L110				NOT ASSIGNED		
A7A1L111	9100-2247	4		INDUCTOR RF-CH-MLD 100NH 10% .105DX.26LG	28480	9100-2247
A7A1L112	9100-2247	4		INDUCTOR RF-CH-MLD 100NH 10% .105DX.26LG	28480	9100-2247
A7A1L113	9100-2247	4		INDUCTOR RF-CH-MLD 100NH 10% .105DX.26LG	28480	9100-2247
A7A1MP1	0340-0840	8		INSULATOR SLBL-LAC-CMPD	28480	0340-0840
A7A1Q1	1853-0459	3		TRANSISTOR PNP SI PD=625MW FT=200MHZ	28480	1853-0459
A7A1Q2	1854-0477	7		TRANSISTOR NPN 2N2222A SI TO-18 PD=500MW	04713	2N2222A
A7A1Q3	1854-0477	7		TRANSISTOR NPN 2N2222A SI TO-18 PD=500MW	04713	2N2222A
A7A1Q4	1854-0944	3	10	TRANSISTOR NPN SI PD=600MW FT=5GHZ	28480	1854-0944
A7A1Q5	1853-0281	9		TRANSISTOR PNP 2N2907A SI TO-18 PD=400MW	04713	2N2907A
A7A1Q6	1854-0809	9		TRANSISTOR NPN 2N2369A SI TO-18 PD=360MW	28480	1854-0809
A7A1Q7	1858-0071	5	2	TRANSISTOR ARRAY PLSTC TO-116	04713	MPQ3798
A7A1Q8-Q100				NOT ASSIGNED		
A7A1Q101	1854-0944	3		TRANSISTOR NPN SI PD=600MW FT=5GHZ	28480	1854-0944
A7A1Q102	1854-0944	3		TRANSISTOR NPN SI PD=600MW FT=5GHZ	28480	1854-0944
A7A1Q103	1854-0944	3		TRANSISTOR NPN SI PD=600MW FT=5GHZ	28480	1854-0944
A7A1Q104	1854-0944	3		TRANSISTOR NPN SI PD=600MW FT=5GHZ	28480	1854-0944
A7A1Q105	1854-0944	3		TRANSISTOR NPN SI PD=600MW FT=5GHZ	28480	1854-0944
A7A1Q106	1854-0944	3		TRANSISTOR NPN SI PD=600MW FT=5GHZ	28480	1854-0944
A7A1Q107	1854-0944	3		TRANSISTOR NPN SI PD=600MW FT=5GHZ	28480	1854-0944
A7A1Q108	1854-0944	3		TRANSISTOR NPN SI PD=600MW FT=5GHZ	28480	1854-0944
A7A1Q109				NOT ASSIGNED		
A7A1Q110	1854-0944	3		TRANSISTOR NPN SI PD=600MW FT=5GHZ	28480	1854-0944
A7A1R1	0699-1361	9		RESISTOR 51.1 1% .125W F TC=0+-100	28480	0699-1361
A7A1R2	0698-7284	5	4	RESISTOR 100K 1% .05W F TC=0+-100	24546	C3-1/8-T0-1003-F
A7A1R3	0698-7261	8		RESISTOR 11K 1% .05W F TC=0+-100	24546	C3-1/8-T0-1102-F
A7A1R4	0699-1415	4		RESISTOR 100 1% .125W F TC=0+-100	28480	0699-1415
A7A1R5	0699-1372	2		RESISTOR 1.47K 1% .125W F TC=0+-100	28480	0699-1372
A7A1R6	0698-3445	2		RESISTOR 348 1% .125W F TC=0+-100	24546	C4-1/8-T0-348R-F
A7A1R7	0698-7205	0		RESISTOR 51.1 1% .05W F TC=0+-100	24546	C3-1/8-T0-51R1-F
A7A1R8	0698-7253	8		RESISTOR 5.11K 1% .05W F TC=0+-100	24546	C3-1/8-T0-5111-F
A7A1R9	0757-0416	7		RESISTOR 511 1% .125W F TC=0+-100	24546	C4-1/8-T0-511R-F
A7A1R10	0698-7236	7		RESISTOR 1K 1% .05W F TC=0+-100	24546	C3-1/8-T0-1001-F
A7A1R11	0698-7212	9		RESISTOR 100 1% .05W F TC=0+-100	24546	C3-1/8-T0-100R-F
A7A1R12	0698-7281	2	1	RESISTOR 75K 2% .05W F TC=0+-100	24546	C3-1/8-T0-7502-G
A7A1R13				NOT ASSIGNED		
A7A1R14	0698-7284	5		RESISTOR 100K 1% .05W F TC=0+-100	24546	C3-1/8-T0-1003-F
A7A1R15	0698-7260	7		RESISTOR 10K 1% .05W F TC=0+-100	24546	C3-1/8-T0-1002-F
A7A1R16	0699-1415	4		RESISTOR 100 1% .125W F TC=0+-100	28480	0699-1415
A7A1R17	0698-7231	2	8	RESISTOR 619 1% .05W F TC=0+-100	24546	C3-1/8-T0-619R-F
A7A1R18	0698-4514	8	1	RESISTOR 105K 1% .125W F TC=0+-100	24546	C4-1/8-T0-1053-F
A7A1R19	0698-7245	8		RESISTOR 2.37K 1% .05W F TC=0+-100	24546	C3-1/8-T0-2371-F
A7A1R20	0698-7277	6		RESISTOR 51.1K 1% .05W F TC=0+-100	24546	C3-1/8-T0-5112-F
A7A1R21	0698-7234	5	3	RESISTOR 825 1% .05W F TC=0+-100	24546	C3-1/8-T0-825R-F
A7A1R22	0698-3458	7	4	RESISTOR 348K 1% .125W F TC=0+-100	28480	0698-3458
A7A1R23	0698-7288	9		RESISTOR 147K 1% .05W F TC=0+-100	24546	C3-1/8-T0-1473-F
A7A1R24	0698-7253	8		RESISTOR 5.11K 1% .05W F TC=0+-100	24546	C3-1/8-T0-5111-F
A7A1R25	0698-7236	7		RESISTOR 1K 1% .05W F TC=0+-100	24546	C3-1/8-T0-1001-F

See introduction to this section for ordering information.

\* Indicates factory selected value

Table 6-2. Replaceable Parts

Reference Designation	HP Part Number	C D	Qty	Description	Mfr Code	Mfr Part Number
A7A1R26	0698-7260	7		RESISTOR 10K 1% .05W F TC=0+-100	24546	C3-1/8-T0-1002-F
A7A1R27	0698-3453	2		RESISTOR 196K 1% .125W F TC=0+-100	24546	C4-1/8-T0-1963-F
A7A1R28	0698-7261	8		RESISTOR 11K 1% .05W F TC=0+-100	24546	C3-1/8-T0-1102-F
A7A1R29	0698-7242	5	3	RESISTOR 1.78K 1% .05W F TC=0+-100	24546	C3-1/8-T0-1781-F
A7A1R30	0698-7251	6	1	RESISTOR 4.22K 1% .05W F TC=0+-100	24546	C3-1/8-T0-4221-F
A7A1R31	0698-7231	2		RESISTOR 619 1% .05W F TC=0+-100	24546	C3-1/8-T0-619R-F
A7A1R32	0698-7285	6	1	RESISTOR 110K 1% .05W F TC=0+-100	24546	C3-1/8-T0-1103-F
A7A1R33	2100-3097	7	3	RESISTOR-TRMR 100K 10% C TOP-ADJ 17-TRN	32997	3292W-1-104
A7A1R34	0698-7253	8		RESISTOR 5.11K 1% .05W F TC=0+-100	24546	C3-1/8-T0-5111-F
A7A1R35	0698-7253	8		RESISTOR 5.11K 1% .05W F TC=0+-100	24546	C3-1/8-T0-5111-F
A7A1R36	0698-7272	1	11	RESISTOR 31.6K 1% .05W F TC=0+-100	24546	C3-1/8-T0-3162-F
A7A1R37	0698-7277	6		RESISTOR 51.1K 1% .05W F TC=0+-100	24546	C3-1/8-T0-5112-F
A7A1R38	0698-7277	6		RESISTOR 51.1K 1% .05W F TC=0+-100	24546	C3-1/8-T0-5112-F
A7A1R39	0698-7284	5		RESISTOR 100K 1% .05W F TC=0+-100	24546	C3-1/8-T0-1003-F
A7A1R40				NOT ASSIGNED		
A7A1R41				NOT ASSIGNED		
A7A1R42	0698-7284	5		RESISTOR 100K 1% .05W F TC=0+-100	24546	C3-1/8-T0-1003-F
A7A1R43	0698-7280	0		RESISTOR 68.1K 1% .05W F TC=0+-100	24546	C3-1/8-T0-6812-F
A7A1R44	0699-1354	1		RESISTOR 26.1 1% .125W F TC=0+-100	28480	0699-1354
A7A1R45	0698-7236	7		RESISTOR 1K 1% .05W F TC=0+-100	24546	C3-1/8-T0-1001-F
A7A1R46	0698-7212	9		RESISTOR 100 1% .05W F TC=0+-100	24546	C3-1/8-T0-100R-F
A7A1R47	1810-0503	8	1	NETWORK-RES 16-DIP3.3K OHM X 8	28480	1810-0503
A7A1R48	0698-3457	6		RESISTOR 316K 1% .125W F TC=0+-100	28480	0698-3457
A7A1R49-R100				NOT ASSIGNED		
A7A1R101	0698-7253	8		RESISTOR 5.11K 1% .05W F TC=0+-100	24546	C3-1/8-T0-5111-F
A7A1R102	0698-7260	7		RESISTOR 10K 1% .05W F TC=0+-100	24546	C3-1/8-T0-1002-F
A7A1R103	0698-7253	8		RESISTOR 5.11K 1% .05W F TC=0+-100	24546	C3-1/8-T0-5111-F
A7A1R104	0698-7244	7	8	RESISTOR 2.15K 1% .05W F TC=0+-100	24546	C3-1/8-T0-2151-F
A7A1R105	0699-1361	9		RESISTOR 51.1 1% .125W F TC=0+-100	28480	0699-1361
A7A1R106	0698-7205	0		RESISTOR 51.1 1% .05W F TC=0+-100	24546	C3-1/8-T0-511R-F
A7A1R107	0699-1372	2		RESISTOR 1.47K 1% .125W F TC=0+-100	28480	0699-1372
A7A1R108	0698-3447	4		RESISTOR 422 1% .125W F TC=0+-100	24546	C4-1/8-T0-422R-F
A7A1R109	0699-1419	8		RESISTOR 147 1% .125W F TC=0+-100	28480	0699-1419
A7A1R110	0699-1423	4		RESISTOR 215 1% .125W F TC=0+-100	28480	0699-1423
A7A1R111	0698-3447	4		RESISTOR 422 1% .125W F TC=0+-100	24546	C4-1/8-T0-422R-F
A7A1R112	0698-7260	7		RESISTOR 10K 1% .05W F TC=0+-100	24546	C3-1/8-T0-1002-F
A7A1R113	0698-7253	8		RESISTOR 5.11K 1% .05W F TC=0+-100	24546	C3-1/8-T0-5111-F
A7A1R114	0698-7244	7		RESISTOR 2.15K 1% .05W F TC=0+-100	24546	C3-1/8-T0-2151-F
A7A1R115	0699-1372	2		RESISTOR 1.47K 1% .125W F TC=0+-100	28480	0699-1372
A7A1R116	0698-3447	4		RESISTOR 422 1% .125W F TC=0+-100	24546	C4-1/8-T0-422R-F
A7A1R117	0699-3447	4		RESISTOR 422 1% .125W F TC=0+-100	24546	C4-1/8-T0-422R-F
A7A1R118	0699-1361	9		RESISTOR 51.1 1% .125W F TC=0+-100	28480	0699-1361
A7A1R119-R121				NOT ASSIGNED		
A7A1R122	0698-7260	7		RESISTOR 10K 1% .05W F TC=0+-100	24546	C3-1/8-T0-1002-F
A7A1R123	0698-7253	3		RESISTOR 5.11K 1% .05W F TC=0+-100	24546	C3-1/8-T0-5111-F
A7A1R124	0698-7244	7		RESISTOR 2.15K 1% .05W F TC=0+-100	24546	C3-1/8-T0-2151-F
A7A1R125	0699-1372	2		RESISTOR 1.47K 1% .125W F TC=0+-100	28480	0699-1372
A7A1R126	0698-3447	4		RESISTOR 422 1% .125W F TC=0+-100	24546	C4-1/8-T0-422R-F
A7A1R127-R130				NOT ASSIGNED		
A7A1R131	2100-2061	3	1	RESISTOR-TRMR 200 10% C TOP-ADJ 1-TRN	73138	82PR200
A7A1R132	0698-7211	8	7	RESISTOR 90.9 1% .05W F TC=0+-100	24546	C3-1/8-T0-909R-F
A7A1R133	0698-7211	8		RESISTOR 90.9 1% .05W F TC=0+-100	24546	C3-1/8-T0-909R-F
A7A1R134	0698-7211	8		RESISTOR 90.9 1% .05W F TC=0+-100	24546	C3-1/8-T0-909R-F
A7A1R135	0699-1419	8		RESISTOR 147 1% .125W F TC=0+-100	28480	0699-1419
A7A1R136	0698-3447	4		RESISTOR 422 1% .125W F TC=0+-100	24546	C4-1/8-T0-422R-F
A7A1R137				NOT ASSIGNED		
A7A1R138	0699-1415	4		RESISTOR 100 1% .125W F TC=0+-100	28480	0699-1415
A7A1R139	0699-1361	9		RESISTOR 51.1 1% .125W F TC=0+-100	28480	0699-1361
A7A1R140	0699-1423	4		RESISTOR 215 1% .125W F TC=0+-100	28480	0699-1423
A7A1R141	0699-1361	3		RESISTOR 51.1 1% .125W F TC=0+-100	28480	0699-1361
A7A1R142				NOT ASSIGNED		
A7A1R143	0698-3447	4		RESISTOR 422 1% .125W F TC=0+-100	24546	C4-1/8-T0-422R-F
A7A1R144				NOT ASSIGNED		
A7A1R145				NOT ASSIGNED		
A7A1R146	0757-0419	0		RESISTOR 681 1% .125W F TC=0+-100	24546	C4-1/8-T0-681R-F

See introduction to this section for ordering information.

\* Indicates factory selected value



Table 6-2. Replaceable Parts

Reference Designation	HP Part Number	C D	Qty	Description	Mfr Code	Mfr Part Number
A7A1R147	0699-1372	2		RESISTOR 1.47K 1% .125W F TC=0+-100	28480	0699-1372
A7A1R148	0698-7212	9		RESISTOR 100 1% .05W F TC=0+-100	24546	C3-1/8-T0-100R-F
A7A1R149	0699-1372	2		RESISTOR 1.47K 1% .125W F TC=0+-100	28480	0699-1372
A7A1R150	0757-0419	0		RESISTOR 681 1% .125W F TC=0+-100	24546	C4-1/8-T0-681R-F
A7A1U1	1820-2506	6		IC INV TTL F HEX	07263	74F04PC
A7A1U2	1820-2691	0		IC FF TTL F D-TYPE POS-EDGE-TRIG	07263	74F74PC
A7A1U3	1826-0208	3	1	IC OP AMP GP 8-DIP-P PKG	27014	LM310N
A7A1U4				NOT ASSIGNED		
A7A1U5				NOT ASSIGNED		
A7A1U6	1820-1037	6	1	IC DCDR TTL BCD-TO-7-SEG 4-TO-7-LINE	01295	SN7446AN
<b>2427A TO 2550A</b>						
A7A1U7	1826-0043	4		IC OP AMP GP T0-99 PKG	3L585	CA307T
A7A1U8	1826-0759	9		IC OP AMP GP T0-99 PKG	04713	LM339J
A7A1U9	1826-0111	7		IC OP AMP GP DUAL T0-99 PKG	3L585	CA1458T
<b>2808A AND ABOVE</b>						
A7A1U7	1826-0989	7		IC OP AMP GP 8-DIP-C PKG	28480	1826-0989
A7A1U8	1826-0138	8		IC COMPARATOR GP QUAD 14-DIP-P PKG	01295	LM339N
A7A1U9	1826-0990	0		IC OP AMP GP DUAL P-DIP-C PKG	28480	1826-0990
A7A1U10	1826-0606	5		IC SWITCH ANLG QUAD 16-DIP-C PKG	17856	DG201BK
A7A1U11	1820-1423	4		IC MV TTL LS MONOSTBL RETRIG DUAL	01295	SN74LS123N
A7A1VR1	1902-1428	3	59	DIODE-ZNR 4.6V DO-35 PD=.4W IR=1UA	28480	1902-1428
A7A1VR2-VR100				NOT ASSIGNED		
A7A1VR101	1902-1428	3		DIODE-ZNR 4.6V DO-35 PD=.4W IR=1UA	28480	1902-1428
A7A1VR102	1902-1428	3		DIODE-ZNR 4.6V DO-35 PD=.4W IR=1UA	28480	1902-1428
A7A1VR103	1902-1428	3		DIODE-ZNR 4.6V DO-35 PD=.4W IR=1UA	28480	1902-1428
A7A1VR104	1902-1428	3		DIODE-ZNR 4.6V DO-35 PD=.4W IR=1UA	28480	1902-1428
A7A1VR105	1902-1428	3		DIODE-ZNR 4.6V DO-35 PD=.4W IR=1UA	28480	1902-1428
A7A1VR106	1902-1428	3		DIODE-ZNR 4.6V DO-35 PD=.4W IR=1UA	28480	1902-1428
A7A1VR107	1902-1428	3		DIODE-ZNR 4.6V DO-35 PD=.4W IR=1UA	28480	1902-1428
A7A1VR108	1902-1428	3		DIODE-ZNR 4.6V DO-35 PD=.4W IR=1UA	28480	1902-1428
A7A1VR109	1902-1428	3		DIODE-ZNR 4.6V DO-35 PD=.4W IR=1UA	28480	1902-1428
<b>2427A TO 2512A</b>						
A7A1W1				WIRE JUMPER 22 AWG		
A7A1W2				WIRE JUMPER 22 AWG		
A7A1W3				WIRE JUMPER 22 AWG		
<b>2513A AND ABOVE</b>						
A7A1W1				PART IS ETCHED TRACE ON CIRCUIT BOARD		
A7A1W2				PART IS ETCHED TRACE ON CIRCUIT BOARD		
A7A1W3				PART IS ETCHED TRACE ON CIRCUIT BOARD		
A7A1W4				PART IS ETCHED TRACE ON CIRCUIT BOARD		
A7A1W5				PART IS ETCHED TRACE ON CIRCUIT BOARD		
A7A1W6				PART IS ETCHED TRACE ON CIRCUIT BOARD		
A7A1W7				PART IS ETCHED TRACE ON CIRCUIT BOARD		
A7A1W8				PART IS ETCHED TRACE ON CIRCUIT BOARD		
A7A1W9				PART IS ETCHED TRACE ON CIRCUIT BOARD		
A7A1W10				PART IS ETCHED TRACE ON CIRCUIT BOARD		
A7A1W11				PART IS ETCHED TRACE ON CIRCUIT BOARD		
A7A1W12				PART IS ETCHED TRACE ON CIRCUIT BOARD		
A7A1W13				PART IS ETCHED TRACE ON CIRCUIT BOARD		
A7A1Y1	1GA1-8003	5	1	SAW CMPNT 787.5	28480	1GA1-8003
A7A1Y2	1GA1-8004	6	2	SAW CMPNT 832.5	28480	1GA1-8004
A7A1Y3	1GA1-8002	4	1	SAW CMPNT 742.5	28480	1GA1-8002

See introduction to this section for ordering information.

\* Indicates factory selected value



Table 6-2. Replaceable Parts

Reference Designation	HP Part Number	C D	Qty	Description	Mfr Code	Mfr Part Number
<b>A8</b>  A8	1813-0415	7	1	OSCILLATOR-CRYSTAL=10MHZ, INPUT (OPTION 001 ONLY)	28480	1813-0415
	0515-1227 1400-0249	8 0	45 31	SCREW-MACH M3 X 0.5 6MM-LG 90-DEG-FLH-HD CABLE TIE .062-.625-DIA .091-WD NYL	28480 06383	0515-1227 PLT1M-8

See introduction to this section for ordering information.

\* Indicates factory selected value



Table 6-2. Replaceable Parts

Reference Designation	HP Part Number	C D	Qty	Description	Mfr Code	Mfr Part Number
<b>A9</b>						
A9	08642-60895	5	1	IF LOOP MODULE	28480	08642-60895
A9	08642-69895	3	1	IF LOOP MODULE (RESTORED)	28480	08642-69895
A9A1	08642-60104	9	1	IF VCO ASSEMBLY	28480	08642-60104
A9A2	08642-60105	0	1	FRACTIONAL-N ASSEMBLY	28480	08642-60105
A9FL1	08642-80013	1	3	FLTR LP 3M BKT	28480	08642-80013
A9FL2	08642-80012	0	3	FLTR LP 7POS BKT	28480	08642-80012
A9MP1	08642-20006	6	1	COVER IF VCO	28480	08642-20006
A9MP2	08642-00087	1		FOAM-DAMPING	28480	08642-00087
A9MP3	08642-20007	7	1	BASE IF	28480	08642-20007
A9MP4	08642-40053	5		GASKET FD/THRU13	28480	08642-40053
A9MP5	0515-1521	5		SCREW-MACH M3 X 0.5 5MM-LG 90-DEG-FLH-HD (ATTACH FILTER TO BASE)	28480	0515-1521
A9MP6	08642-20008	8	1	COVER FRACTIONAL-N	28480	08642-20008
A9MP7	08642-00001	9	4	GASKET 7 P FLTR	28480	08642-00001
A9MP8	08642-00002	0	3	GASKET 10 P FLTR	28480	08642-00002
A9MP9	0515-0684	9		SCREW-MACH M4 X 0.7 6MM-LG PAN-HD (ATTACH BOARDS TO BASE)	28480	0515-0684
A9MP10	0515-0381	3		SCREW-MACH M4 X 0.7 10MM-LG PAN-HD (ATTACH COVERS TO BASE)	00000	ORDER BY DESCRIPTION
A9MP11	8160-0472	8		RFI ROUND STRIP BE-CU SN-PL .093-IN-OD (SPIRA SHIELD)	28480	8160-0472
A9MP12	08642-00099	5		SLIDE-MODULE 13 (FRONT)	28480	08642-00099
A9MP13	0515-1102	8		SCREW-MACH M3 X 0.5 8MM-LG 90-DEG-FLH-HD (ATTACH A9MP12 TO BASE)	28480	0515-1102
A9MP14	08642-00057	5		SLIDE-MODUL R23 (REAR, TOP)	28480	08642-00057
A9MP15	08642-00055	3		SLIDE-MODUL R23 (REAR, BOTTOM)	28480	08642-00055
A9MP16	0515-1103	9		SCREW-MACH M3 X 0.5 10MM-LG (ATTACH A9MP14, A9MP15 TO BASE)	28480	0515-1103
A9MP17	08642-80066	4	1	LABEL-IF 60003	28480	08642-80066
A9W1	08642-60042	4	1	CBL-COAX 947 (A9A1J1 TO A9A2J4)	28480	08642-60042
A9W2	5061-4809	0	1	CBL-COAX 934 (A9A1J3 TO A9A2J2)	28480	5061-4809

See introduction to this section for ordering information.

\* Indicates factory selected value



Table 6-2. Replaceable Parts

Reference Designation	HP Part Number	C D	Qty	Description	Mfr Code	Mfr Part Number
<b>A9A1</b>	08642-60104	9	1	IF VCO ASSEMBLY	28480	08642-60104
A9A1C1	0160-0571	0		CAPACITOR-FXD 470PF +-20% 100VDC CER	28480	0160-0571
A9A1C2	0160-4834	6	1	CAPACITOR-FXD .047UF +-10% 100VDC CER	28480	0160-4834
A9A1C3	0180-0141	2	1	CAPACITOR-FXD 50UF+75-10% 50VDC AL	56289	30D506G0500D2
A9A1C4	0160-4527	4		CAPACITOR-FXD 56PF +-5% 200VDC CER 0+-30	28480	0160-4527
A9A1C5	0160-0166	9	1	CAPACITOR-FXD .068UF +-10% 200VDC POLYE	28480	0160-0166
A9A1C6	0160-0576	5		CAPACITOR-FXD .1UF +-20% 50VDC CER	28480	0160-0576
A9A1C7	0160-0576	5		CAPACITOR-FXD .1UF +-20% 50VDC CER	28480	0160-0576
A9A1C8	0160-3324	7		CAPACITOR-FXD 1UF +-5% 100VDC MET-POLYC	28480	0160-3324
A9A1C9	0160-4834	6		CAPACITOR-FXD .047UF +-10% 100VDC CER	28480	0160-4834
A9A1C10	0160-0576	5		CAPACITOR-FXD .1UF +-20% 50VDC CER	28480	0160-0576
A9A1C11	0160-0576	5		CAPACITOR-FXD .1UF +-20% 50VDC CER	28480	0160-0576
A9A1C12	0160-0576	5		CAPACITOR-FXD .1UF +-20% 50VDC CER	28480	0160-0576
A9A1C13	0180-2667	1	2	CAPACITOR-FXD 150UF+-10% 20VDC TA	56289	150D157X9020S2
A9A1C14	0160-0576	5		CAPACITOR-FXD .1UF +-20% 50VDC CER	28480	0160-0576
A9A1C15	0160-0576	5		CAPACITOR-FXD .1UF +-20% 50VDC CER	28480	0160-0576
A9A1C16	0160-0576	5		CAPACITOR-FXD .1UF +-20% 50VDC CER	28480	0160-0576
A9A1C17	0160-0576	5		CAPACITOR-FXD .1UF +-20% 50VDC CER	28480	0160-0576
A9A1C18	0180-2667	1		CAPACITOR-FXD 150UF+-10% 20VDC TA	56289	150D157X9020S2
A9A1C19	0160-0576	5		CAPACITOR-FXD .1UF +-20% 50VDC CER	28480	0160-0576
A9A1C20	0160-3029	9		CAPACITOR-FXD 7.5PF +- .5PF 100VDC CER	28480	0160-3029
A9A1C21	0160-3029	9		CAPACITOR-FXD 7.5PF +- .5PF 100VDC CER	28480	0160-3029
A9A1C22	0160-4520	7		CAPACITOR-FXD 11PF +-5% 200VDC CER 0+-30	28480	0160-4520
A9A1C23	0160-3879	7		CAPACITOR-FXD .01UF +-20% 100VDC CER	28480	0160-3879
A9A1C24	0160-3879	7		CAPACITOR-FXD .01UF +-20% 100VDC CER	28480	0160-3879
A9A1C25	0160-3879	7		CAPACITOR-FXD .01UF +-20% 100VDC CER	28480	0160-3879
A9A1C26	0160-3879	7		CAPACITOR-FXD .01UF +-20% 100VDC CER	28480	0160-3879
A9A1C27	0160-0575	4	6	CAPACITOR-FXD .047UF +-20% 50VDC CER	28480	0160-0575
A9A1C28	0121-0564	9		CAPACITOR-V TRMR-AIR 1.7-7.4PF 175V	28480	0121-0564
A9A1C29	0160-0573	2		CAPACITOR-FXD 4700PF +-20% 100VDC CER	28480	0160-0573
A9A1C30	0160-4383	0		CAPACITOR-FXD 6.8PF +- .5PF 200VDC CER	28480	0160-4383
A9A1C31	0160-4383	0		CAPACITOR-FXD 6.8PF +- .5PF 200VDC CER	28480	0160-4383
A9A1C32	0160-3874	2		CAPACITOR-FXD 10PF +- .5PF 200VDC CER	28480	0160-43874
A9A1C33	0160-3879	7		CAPACITOR-FXD .01UF +-20% 100VDC CER	28480	0160-3879
A9A1C34	0160-3879	7		CAPACITOR-FXD .01UF +-20% 100VDC CER	28480	0160-3879
A9A1C35	0160-3879	7		CAPACITOR-FXD .01UF +-20% 100VDC CER	28480	0160-3879
A9A1C36	0160-3879	7		CAPACITOR-FXD .01UF +-20% 100VDC CER	28480	0160-3879
A9A1C37	0160-0575	4		CAPACITOR-FXD .047UF +-20% 50VDC CER	28480	0160-0575
A9A1C38	0121-0564	9		CAPACITOR-V TRMR-AIR 1.7-7.4PF 175V	28480	0121-0564
A9A1C39	0160-0573	2		CAPACITOR-FXD 4700PF +-20% 100VDC CER	28480	0160-0573
A9A1C40	0160-3873	1		CAPACITOR-FXD 4.7PF +- .5PF 200VDC CER	28480	0160-3873
A9A1C41	0160-3873	1		CAPACITOR-FXD 4.7PF +- .5PF 200VDC CER	28480	0160-3873
A9A1C42	0160-4383	0		CAPACITOR-FXD 6.8PF +- .5PF 200VDC CER	20932	5024E0200RD689D
A9A1C43	0160-3879	7		CAPACITOR-FXD .01UF +-20% 100VDC CER	28480	0160-3879
A9A1C44	0160-3879	7		CAPACITOR-FXD .01UF +-20% 100VDC CER	28480	0160-3879
A9A1C45	0160-3879	7		CAPACITOR-FXD .01UF +-20% 100VDC CER	28480	0160-3879
A9A1C46	0160-3879	7		CAPACITOR-FXD .01UF +-20% 100VDC CER	28480	0160-3879
A9A1C47	0160-0575	4		CAPACITOR-FXD .047UF +-20% 50VDC CER	28480	0160-0575
A9A1C48	0121-0564	9		CAPACITOR-V TRMR-AIR 1.7-7.4PF 175V	28480	0121-0564
A9A1C49	0160-0573	2		CAPACITOR-FXD 4700PF +-20% 100VDC CER	28480	0160-0573
A9A1C50	0160-4518	3		CAPACITOR-FXD 3.9PF +- .5PF 200VDC CER	28480	0160-4518
A9A1C51	0160-4518	3		CAPACITOR-FXD 3.9PF +- .5PF 200VDC CER	28480	0160-4518
A9A1C52	0160-4498	8		CAPACITOR-FXD 5.6PF +- .5PF 200VDC CER	28480	0160-4498
A9A1C53	0160-3879	7		CAPACITOR-FXD .01UF +-20% 100VDC CER	28480	0160-3879
A9A1C54	0160-3879	7		CAPACITOR-FXD .01UF +-20% 100VDC CER	28480	0160-3879
A9A1C55	0160-3879	7		CAPACITOR-FXD .01UF +-20% 100VDC CER	28480	0160-3879
A9A1C56	0160-3879	7		CAPACITOR-FXD .01UF +-20% 100VDC CER	28480	0160-3879
A9A1C57	0160-0575	4		CAPACITOR-FXD .047UF +-20% 50VDC CER	28480	0160-0575
A9A1C58	0121-0452	4		CAPACITOR-V TRMR-AIR 1.3-5.4PF 175V	74970	187-0103-028
A9A1C59	0160-0573	2		CAPACITOR-FXD 4700PF +-20% 100VDC CER	28480	0160-0573
A9A1C60	0160-4619	5	4	CAPACITOR-FXD 2.7PF +- .25PF 200VDC CER	28480	0160-4619
A9A1C61	0160-4619	5		CAPACITOR-FXD 2.7PF +- .25PF 200VDC CER	28480	0160-4619
A9A1C62	0160-4518	3		CAPACITOR-FXD 3.9PF +- .5PF 200VDC CER	28480	0160-4518
A9A1C63	0160-3879	7		CAPACITOR-FXD .01UF +-20% 100VDC CER	28480	0160-3879
A9A1C64	0160-3879	7		CAPACITOR-FXD .01UF +-20% 100VDC CER	28480	0160-3879
A9A1C65	0160-3879	7		CAPACITOR-FXD .01UF +-20% 100VDC CER	28480	0160-3879

See introduction to this section for ordering information.

\* Indicates factory selected value

Table 6-2. Replaceable Parts

Reference Designation	HP Part Number	C D	Qty	Description	Mfr Code	Mfr Part Number
A9A1C66	0160-3879	7		CAPACITOR-FXD .01UF +-20% 100VDC CER	28480	0160-3879
A9A1C67	0160-0575	4		CAPACITOR-FXD .047UF +-20% 50VDC CER	28480	0160-0575
A9A1C68	0121-0452	4		CAPACITOR-V TRMR-AIR 1.3-5.4PF 175V	74970	187-0103-028
A9A1C69	0160-0573	2		CAPACITOR-FXD 4700PF +-20% 100VDC CER	28480	0160-0573
24274 TO 2613A						
A9A1C70	0160-4619	5		CAPACITOR-FXD 2.7PF +- .25PF 200VDC CER	28480	0160-4619
A9A1C71	0160-4619	5		CAPACITOR-FXD 2.7PF +- .25PF 200VDC CER	28480	0160-4619
2615A AND ABOVE						
A9A1C70	0160-3872	0	1	CAPACITOR-FXD 2.2PF +- .25PF 200VDC CER	28480	0160-3872
A9A1C71	0160-4382	9	1	CAPACITOR-FXD 3.3PF +- .25PF 200VDC CER	28480	0160-4382
A9A1C72	0160-4518	3		CAPACITOR-FXD 3.9PF +- .5PF 200VDC CER	28480	0160-4518
A9A1C73	0160-3879	7		CAPACITOR-FXD .01UF +-20% 100VDC CER	28480	0160-3879
A9A1C74	0160-3879	7		CAPACITOR-FXD .01UF +-20% 100VDC CER	28480	0160-3879
A9A1C75	0160-3879	7		CAPACITOR-FXD .01UF +-20% 100VDC CER	28480	0160-3879
A9A1C76	0160-3879	7		CAPACITOR-FXD .01UF +-20% 100VDC CER	28480	0160-3879
A9A1C77	0160-0575	4		CAPACITOR-FXD .047UF +-20% 50VDC CER	28480	0160-0575
A9A1C78	0121-0452	4		CAPACITOR-V TRMR-AIR 1.3-5.4PF 175V	74970	187-0103-028
A9A1C79	0160-0573	2		CAPACITOR-FXD 4700PF +-20% 100VDC CER	28480	0160-0573
A9A1C80	0160-3879	7		CAPACITOR-FXD .01UF +-20% 100VDC CER	28480	0160-3879
A9A1C81	0160-3879	7		CAPACITOR-FXD .01UF +-20% 100VDC CER	28480	0160-3879
A9A1C82	0180-0491	5		CAPACITOR-FXD 10UF+-20% 25VDC TA	28480	0180-0491
A9A1C83	0160-3879	7		CAPACITOR-FXD .01UF +-20% 100VDC CER	28480	0160-3879
A9A1C84	0160-3879	7		CAPACITOR-FXD .01UF +-20% 100VDC CER	28480	0160-3879
A9A1C85				NOT ASSIGNED		
A9A1C86	0160-3879	7		CAPACITOR-FXD .01UF +-20% 100VDC CER	28480	0160-3879
A9A1C87	0160-3879	7		CAPACITOR-FXD .01UF +-20% 100VDC CER	28480	0160-3879
A9A1C88	0160-3879	7		CAPACITOR-FXD .01UF +-20% 100VDC CER	28480	0160-3879
A9A1C89	0160-3879	7		CAPACITOR-FXD .01UF +-20% 100VDC CER	28480	0160-3879
A9A1C90	0160-3879	7		CAPACITOR-FXD .01UF +-20% 100VDC CER	28480	0160-3879
A9A1CR1	1901-0050	3		DIODE-SWITCHING 80V 200MA 2NS DO-35	28480	1901-0050
A9A1CR2	1901-0050	3		DIODE-SWITCHING 80V 200MA 2NS DO-35	28480	1901-0050
A9A1CR3	1901-0518	8		DIODE-SM SIG SCHOTTKY	28480	1901-0518
A9A1CR4	1901-0518	8		DIODE-SM SIG SCHOTTKY	28480	1901-0518
A9A1CR5	1901-0518	8		DIODE-SM SIG SCHOTTKY	28480	1901-0518
A9A1CR6	1901-0050	3		DIODE-SWITCHING 80V 200MA 2NS DO-35	28480	1901-0050
A9A1CR7	1901-0050	3		DIODE-SWITCHING 80V 200MA 2NS DO-35	28480	1901-0050
A9A1CR8	1901-0050	3		DIODE-SWITCHING 80V 200MA 2NS DO-35	28480	1901-0050
A9A1CR9	1901-0050	3		DIODE-SWITCHING 80V 200MA 2NS DO-35	28480	1901-0050
A9A1CR10	1901-1097	0	6	DIODE-PIN	28480	1901-1097
A9A1CR11	0122-0159	0	12	DIODE-VVC 47PF 5% BVR=60V DO-7 Q=200-MIN	28480	0122-0159
A9A1CR12	0122-0159	0		DIODE-VVC 47PF 5% BVR=60V DO-7 Q=200-MIN	28480	0122-0159
A9A1CR13	0122-0159	0		DIODE-VVC 47PF 5% BVR=60V DO-7 Q=200-MIN	28480	0122-0159
A9A1CR14	0122-0159	0		DIODE-VVC 47PF 5% BVR=60V DO-7 Q=200-MIN	28480	0122-0159
A9A1CR15	1901-1097	0		DIODE-PIN	28480	1901-1097
A9A1CR16	0122-0159	0		DIODE-VVC 47PF 5% BVR=60V DO-7 Q=200-MIN	28480	0122-0159
A9A1CR17	0122-0159	0		DIODE-VVC 47PF 5% BVR=60V DO-7 Q=200-MIN	28480	0122-0159
A9A1CR18	0122-0159	0		DIODE-VVC 47PF 5% BVR=60V DO-7 Q=200-MIN	28480	0122-0159
A9A1CR19	0122-0159	0		DIODE-VVC 47PF 5% BVR=60V DO-7 Q=200-MIN	28480	0122-0159
A9A1CR20	1901-1097	0		DIODE-PIN	28480	1901-1097
A9A1CR21	0122-0159	0		DIODE-VVC 47PF 5% BVR=60V DO-7 Q=200-MIN	28480	0122-0159
A9A1CR22	0122-0159	0		DIODE-VVC 47PF 5% BVR=60V DO-7 Q=200-MIN	28480	0122-0159
A9A1CR23	0122-0159	0		DIODE-VVC 47PF 5% BVR=60V DO-7 Q=200-MIN	28480	0122-0159
A9A1CR24	0122-0159	0		DIODE-VVC 47PF 5% BVR=60V DO-7 Q=200-MIN	28480	0122-0159
A9A1CR25	1901-1097	0		DIODE-PIN	28480	1901-1097
A9A1CR26	0122-0158	9	12	DIODE-VVC 33PF 5% BVR=60V DO-7 Q=200-MIN	28480	0122-0158
A9A1CR27	0122-0158	9		DIODE-VVC 33PF 5% BVR=60V DO-7 Q=200-MIN	28480	0122-0158
A9A1CR28	0122-0158	9		DIODE-VVC 33PF 5% BVR=60V DO-7 Q=200-MIN	28480	0122-0158
A9A1CR29	0122-0158	9		DIODE-VVC 33PF 5% BVR=60V DO-7 Q=200-MIN	28480	0122-0158
A9A1CR30	1901-1097	0		DIODE-PIN	28480	1901-1097
A9A1CR31	0122-0158	9		DIODE-VVC 33PF 5% BVR=60V DO-7 Q=200-MIN	28480	0122-0158
A9A1CR32	0122-0158	9		DIODE-VVC 33PF 5% BVR=60V DO-7 Q=200-MIN	28480	0122-0158
A9A1CR33	0122-0158	9		DIODE-VVC 33PF 5% BVR=60V DO-7 Q=200-MIN	28480	0122-0158
A9A1CR34	0122-0158	9		DIODE-VVC 33PF 5% BVR=60V DO-7 Q=200-MIN	28480	0122-0158
A9A1CR35	1901-1097	0		DIODE-PIN	28480	1901-1097
A9A1CR36	0122-0158	9		DIODE-VVC 33PF 5% BVR=60V DO-7 Q=200-MIN	28480	0122-0158
A9A1CR37	0122-0158	9		DIODE-VVC 33PF 5% BVR=60V DO-7 Q=200-MIN	28480	0122-0158
A9A1CR38	0122-0158	9		DIODE-VVC 33PF 5% BVR=60V DO-7 Q=200-MIN	28480	0122-0158
A9A1CR39	0122-0158	9		DIODE-VVC 33PF 5% BVR=60V DO-7 Q=200-MIN	28480	0122-0158

See introduction to this section for ordering information.

\* Indicates factory selected value



Table 6-2. Replaceable Parts

Reference Designation	HP Part Number	C D	Qty	Description	Mfr Code	Mfr Part Number
A9A1E1	9170-0029	3		CORE-SHIELDING BEAD	28480	9170-0029
A9A1J1	1250-2090	4		CONNECTOR-RF SMC M SGL-HOLE-RR 50-OHM	28480	1250-2090
A9A1J2	08642-20081	7		ELSTMR COND SMC	28480	08642-20081
A9A1J3	1251-8758	5	8	CONN-POST TYPE .100-PIN-SPCG 8-CONT	28480	1251-8758
	1250-2090	4		CONNECTOR-RF SMC M SGL-HOLE-RR 50-OHM	28480	1250-2090
	08642-20081	7		ELSTMR COND SMC	28480	08642-20081
A9A1J4	1250-2090	4		CONNECTOR-RF SMC M SGL-HOLE-RR 50-OHM	28480	1250-2090
A9A1J5	08642-20078	2		ELSTMR CON SMC D	28480	08642-20078
	1251-8759	6	6	CONN-POST TYPE .100-PIN-SPCG 11-CONT	28480	1251-8759
A9A1L1	9100-1629	4	3	INDUCTOR RF-CH-MLD 47UH 5% .166DX.385LG	28480	9100-1629
A9A1L2	9100-1629	4		INDUCTOR RF-CH-MLD 47UH 5% .166DX.385LG	28480	9100-1629
A9A1L3	9100-1629	4		INDUCTOR RF-CH-MLD 47UH 5% .166DX.385LG	28480	9100-1629
A9A1L4	08642-60026	4	1	COIL ASSY 7 TURN	28480	08642-60026
<i>2427A TO 2637A</i>						
A9A1L5	9140-0179	1	2	INDUCTOR RF-CH-MLD 22UH 10% .166DX.385LG	28480	9140-0179
A9A1L6	9140-0179	1		INDUCTOR RF-CH-MLD 22UH 10% .166DX.385LG	28480	9140-0179
<i>2728A AND ABOVE</i>						
A9A1L5	9140-0453	4		INDUCTOR RF-CH-MLD 6.8UF 5% .166DX .385LG	28480	9100-0453
A9A1L6	9140-0453	4		INDUCTOR RF-CH-MLD 6.8UF 5% .166DX .385LG	28480	9100-0453
A9A1L7	08642-60028	6	1	COIL ASSY 5.5 TURN	28480	08642-60028
<i>2427A TO 2637A</i>						
A9A1L8	9100-1621	6	5	INDUCTOR RF-CH-MLD 18UH 10% .166DX.385LG	28480	9100-1621
A9A1L9	9100-1621	6		INDUCTOR RF-CH-MLD 18UH 10% .166DX.385LG	28480	9100-1621
<i>2728A AND ABOVE</i>						
A9A1L8	9100-3562	8		INDUCTOR RF-CH-MLD 4.7UH 5% .166DX .385LG	28480	9100-3562
A9A1L9	9100-3562	8		INDUCTOR RF-CH-MLD 4.7UH 5% .166DX .385LG	28480	9100-3562
A9A1L10	08642-60025	3	2	COIL ASSY 5 TURN	28480	08642-60025
<i>2427A TO 2637A</i>						
A9A1L11	9100-1621	6		INDUCTOR RF-CH-MLD 18UH 10% .166DX.385LG	28480	9100-1621
A9A1L12	9100-1621	6		INDUCTOR RF-CH-MLD 18UH 10% .166DX.385LG	28480	9100-1621
<i>2728A AND ABOVE</i>						
A9A1L11	9100-3562	8		INDUCTOR RF-CH-MLD 4.7UH 5% .166DX .385LG	28480	9100-3562
A9A1L12	9100-3562	8		INDUCTOR RF-CH-MLD 4.7UH 5% .166DX .385LG	28480	9100-3562
A9A1L13	08642-60025	3		COIL ASSY 5 TURN	28480	08642-60025
<i>2427A TO 2637A</i>						
A9A1L14	9100-1620	5		INDUCTOR RF-CH-MLD 15UH 10% .166DX.385LG	28480	9100-1620
A9A1L15	9100-1620	5		INDUCTOR RF-CH-MLD 15UH 10% .166DX.385LG	28480	9100-1620
<i>2728A AND ABOVE</i>						
A9A1L14	9100-3562	8		INDUCTOR RF-CH-MLD 4.7UH 5% .166DX .385LG	28480	9100-3562
A9A1L15	9100-3562	8		INDUCTOR RF-CH-MLD 4.7UH 5% .166DX .385LG	28480	9100-3562
A9A1L16	08642-60027	5	1	COIL ASSY 4.5 TURN	28480	08642-60027
<i>2427A TO 2637A</i>						
A9A1L17	9100-1620	5		INDUCTOR RF-CH-MLD 15UH 10% .166DX.385LG	28480	9100-1620
A9A1L18	9100-1620	5		INDUCTOR RF-CH-MLD 15UH 10% .166DX.385LG	28480	9100-1620
<i>2728A AND ABOVE</i>						
A9A1L17	9100-3562	8		INDUCTOR RF-CH-MLD 4.7UH 5% .166DX .385LG	28480	9100-3562
A9A1L18	9100-3562	8		INDUCTOR RF-CH-MLD 4.7UH 5% .166DX .385LG	28480	9100-3562
A9A1L19	08642-60024	2	1	COIL ASSY 4 TURN	28480	08642-60024
<i>2427A TO 2637A</i>						
A9A1L20	9140-0178	0	2	INDUCTOR RF-CH-MLD 12UH 10% .166DX.385LG	28480	9140-0178
A9A1L21	9140-0178	0		INDUCTOR RF-CH-MLD 12UH 10% .166DX.385LG	28480	9140-0178
<i>2728A AND ABOVE</i>						
A9A1L20	9100-3553	7		INDUCTOR RF-CH-MLD 3.9UH 5% .166DX .385LG	28480	9100-3553
A9A1L21	9100-3553	7		INDUCTOR RF-CH-MLD 3.7UH 5% .166DX .385LG	28480	9100-3553
A9A1L22	9140-1087	2		INDUCTOR-FIXED 120-1300 HZ	28480	9140-1087
A9A1L23	9140-1087	2		INDUCTOR-FIXED 120-1300 HZ	28480	9140-1087
A9A1L24	9140-1087	2		INDUCTOR-FIXED 120-1300 HZ	28480	9140-1087
A9A1L25	9140-1087	2		INDUCTOR-FIXED 120-1300 HZ	28480	9140-1087

See introduction to this section for ordering information.

\* Indicates factory selected value



Table 6-2. Replaceable Parts

Reference Designation	HP Part Number	C D	Qty	Description	Mfr Code	Mfr Part Number
A9A1R26	0698-7253	8	3	RESISTOR 5.11K 1% .05W F TC=0+-100	24546	C3-1/8-T0-5111-F
A9A1R27	2100-3286	6		RESISTOR-TRMR 10K 10% C TOP-ADJ 17-TRN	32997	3292W-1-103
A9A1R28	0698-7212	9		RESISTOR 100 1% .05W F TC=0+-100	24546	C3-1/8-T0-100R-F
A9A1R29	0698-7274	3		RESISTOR 38.3K 1% .05W F TC=0+-100	24546	C3-1/8-T0-3832-F
A9A1R30	0698-7261	8		RESISTOR 11K 1% .05W F TC=0+-100	24546	C3-1/8-T0-1102-F
A9A1R31	0698-7260	7		RESISTOR 10K 1% .05W F TC=0+-100	24546	C3-1/8-T0-1002-F
A9A1R32	0698-7229	8	RESISTOR 511 1% .05W F TC=0+-100	24546	C3-1/8-T0-511R-F	
A9A1R33	0698-7228	7	RESISTOR 464 1% .05W F TC=0+-100	24546	C3-1/8-T0-464R-F	
A9A1R34	0698-7272	1	RESISTOR 31.6K 1% .05W F TC=0+-100	24546	C3-1/8-T0-3162-F	
A9A1R35	0698-7244	7	RESISTOR 2.15K 1% .05W F TC=0+-100	24546	C3-1/8-T0-2151-F	
A9A1R36	0698-7260	7	RESISTOR 10K 1% .05W F TC=0+-100	24546	C3-1/8-T0-1002-F	
A9A1R37	0698-7260	7	RESISTOR 10K 1% .05W F TC=0+-100	24546	C3-1/8-T0-1002-F	
A9A1R38	0698-7273	2	RESISTOR 34.8K 1% .05W F TC=0+-100	24546	C3-1/8-T0-3482-F	
A9A1R39	0698-7252	7	RESISTOR 4.64K 1% .05W F TC=0+-100	24546	C3-1/8-T0-4641-F	
A9A1R40	0698-7252	7	RESISTOR 4.64K 1% .05W F TC=0+-100	24546	C3-1/8-T0-4641-F	
A9A1R41	0757-0465	6	RESISTOR 100K 1% .125W F TC=0+-100	24546	C4-1/8-T0-1003-F	
A9A1R42	0698-0084	9	RESISTOR 2.15K 1% .125W F TC=0+-100	24546	C4-1/8-T0-2151-F	
A9A1R43	0698-7273	2	RESISTOR 34.8K 1% .05W F TC=0+-100	24546	C3-1/8-T0-3482-F	
A9A1R44	0698-7252	7	RESISTOR 4.64K 1% .05W F TC=0+-100	24546	C3-1/8-T0-4641-F	
A9A1R45	0698-7252	7	RESISTOR 4.64K 1% .05W F TC=0+-100	24546	C3-1/8-T0-4641-F	
A9A1R46	0757-0465	6	RESISTOR 100K 1% .125W F TC=0+-100	24546	C4-1/8-T0-1003-F	
A9A1R47	0698-0084	9	RESISTOR 2.15K 1% .125W F TC=0+-100	24546	C4-1/8-T0-2151-F	
A9A1R48	0698-7273	2	RESISTOR 34.8K 1% .05W F TC=0+-100	24546	C3-1/8-T0-3482-F	
A9A1R49	0698-7252	7	RESISTOR 4.64K 1% .05W F TC=0+-100	24546	C3-1/8-T0-4641-F	
A9A1R50	0698-7252	7	RESISTOR 4.64K 1% .05W F TC=0+-100	24546	C3-1/8-T0-4641-F	
A9A1R51	0757-0465	6	RESISTOR 100K 1% .125W F TC=0+-100	24546	C4-1/8-T0-1003-F	
A9A1R52	0698-0084	9	RESISTOR 2.15K 1% .125W F TC=0+-100	24546	C4-1/8-T0-2151-F	
A9A1R53	0698-7273	2	RESISTOR 34.8K 1% .05W F TC=0+-100	24546	C3-1/8-T0-3482-F	
A9A1R54	0698-7252	7	RESISTOR 4.64K 1% .05W F TC=0+-100	24546	C3-1/8-T0-4641-F	
A9A1R55	0698-7252	7	RESISTOR 4.64K 1% .05W F TC=0+-100	24546	C3-1/8-T0-4641-F	
A9A1R56	0757-0465	6	RESISTOR 100K 1% .125W F TC=0+-100	24546	C4-1/8-T0-1003-F	
A9A1R57	0698-0084	9	RESISTOR 2.15K 1% .125W F TC=0+-100	24546	C4-1/8-T0-2151-F	
A9A1R58	0698-7273	2	RESISTOR 34.8K 1% .05W F TC=0+-100	24546	C3-1/8-T0-3482-F	
A9A1R59	0698-7252	7	RESISTOR 4.64K 1% .05W F TC=0+-100	24546	C3-1/8-T0-4641-F	
A9A1R60	0698-7252	7	RESISTOR 4.64K 1% .05W F TC=0+-100	24546	C3-1/8-T0-4641-F	
A9A1R61	0757-0465	6	RESISTOR 100K 1% .125W F TC=0+-100	24546	C4-1/8-T0-1003-F	
A9A1R62	0698-0084	9	RESISTOR 2.15K 1% .125W F TC=0+-100	24546	C4-1/8-T0-2151-F	
A9A1R63	0698-7273	2	RESISTOR 34.8K 1% .05W F TC=0+-100	24546	C3-1/8-T0-3482-F	
A9A1R64	0698-7252	7	RESISTOR 4.64K 1% .05W F TC=0+-100	24546	C3-1/8-T0-4641-F	
A9A1R65	0698-7252	7	RESISTOR 4.64K 1% .05W F TC=0+-100	24546	C3-1/8-T0-4641-F	
A9A1R66	0757-0465	6	RESISTOR 100K 1% .125W F TC=0+-100	24546	C4-1/8-T0-1003-F	
A9A1R67	0698-0084	9	RESISTOR 2.15K 1% .125W F TC=0+-100	24546	C4-1/8-T0-2151-F	
A9A1R68	0698-7206	1	RESISTOR 56.2 1% .05W F TC=0+-100	24546	C3-1/8-T0-56R2-F	
A9A1R69	0757-0730	8	RESISTOR 750 1% .25W F TC=0+-100	24546	C5-1/4-T0-751-F	
A9A1R70	0698-7188	8	RESISTOR 10 1% .05W F TC=0+-100	24546	C3-1/8-T0-10R-F	
A9A1R71	0698-7188	8	RESISTOR 10 1% .05W F TC=0+-100	24546	C3-1/8-T0-10R-F	
A9A1R72	0698-3444	1	RESISTOR 316 1% .125W F TC=0+-100	24546	C4-1/8-T0-316R-F	
A9A1R73	0698-7198	0	RESISTOR 26.1 1% .05W F TC=0+-100	24546	C3-1/8-T0-26R1-F	
A9A1R74	0698-7206	1	RESISTOR 56.2 1% .05W F TC=0+-100	24546	C3-1/8-T0-56R2-F	
A9A1R75	0757-0274	5	RESISTOR 1.21K 1% .125W F TC=0+-100	24546	C4-1/8-T0-1211-F	
A9A1R76	0698-7243	6	RESISTOR 1.96K 1% .05W F TC=0+-100	24546	C3-1/8-T0-1961-F	
A9A1R77	0698-7243	6	RESISTOR 1.96K 1% .05W F TC=0+-100	24546	C3-1/8-T0-1961-F	
<b>2427A TO 2613A A9A1R78</b>	0698-7212	9	RESISTOR 100 1% .05W F TC=0+-100	24546	C3-1/8-T0-100R-F	
<b>2615A AND ABOVE A9A1R78</b>			NOT ASSIGNED			
A9A1T1	08640-60355	0	1	TRANSFMR-RF BLU	28480	08640-60355
A9A1TP1	0360-0535	0		TERMINAL TEST POINT PCB	00000	ORDER BY DESCRIPTION
A9A1TP2	0360-0535	0		TERMINAL TEST POINT PCB	00000	ORDER BY DESCRIPTION
A9A1TP3	0360-0535	0		TERMINAL TEST POINT PCB	00000	ORDER BY DESCRIPTION
A9A1TP4				NOT ASSIGNED		
A9A1TP5	0360-0535	0		TERMINAL TEST POINT PCB	00000	ORDER BY DESCRIPTION
A9A1TP6	0360-0535	0		TERMINAL TEST POINT PCB	00000	ORDER BY DESCRIPTION
A9A1VR1	1902-0967	3	1	DIODE-ZNR 24V 5% DO-35 PD=.4W TC=+.094%	28480	1902-0967
A9A1VR2	1902-0943	5		DIODE-ZNR 2.4V 5% DO-35 PD=.4W TC=-.037%	28480	1902-0943
A9A1VR3	1902-0943	5		DIODE-ZNR 2.4V 5% DO-35 PD=.4W TC=-.037%	28480	1902-0943

See introduction to this section for ordering information.

\* Indicates factory selected value



Table 6-2. Replaceable Parts

Reference Designation	HP Part Number	C D	Qty	Description	Mfr Code	Mfr Part Number
<b>A9A2</b>	08642-60105	0	1	FRACTIONAL-N ASSEMBLY	28480	08642-60105
A9A2C1	0180-2620	6	11	CAPACITOR-FXD 2.2UF+-10% 50VDC TA	25088	D2R2GS1B50K
A9A2C2	0180-2620	6		CAPACITOR-FXD 2.2UF+-10% 50VDC TA	25088	D2R2GS1B50K
A9A2C3	0160-0576	5		CAPACITOR-FXD .1UF +-20% 50VDC CER	28480	0160-0576
A9A2C4	0180-0491	5		CAPACITOR-FXD 10UF+-20% 25VDC TA	28480	0180-0491
A9A2C5	0180-0491	5		CAPACITOR-FXD 10UF+-20% 25VDC TA	28480	0180-0491
A9A2C6	0160-0576	5		CAPACITOR-FXD .1UF +-20% 50VDC CER	28480	0160-0576
A9A2C7	0180-2618	2		CAPACITOR-FXD 33UF+-10% 10VDC TA	25088	D33GS1B10K
A9A2C8	0180-2618	2		CAPACITOR-FXD 33UF+-10% 10VDC TA	25088	D33GS1B10K
A9A2C9	0160-0576	5		CAPACITOR-FXD .1UF +-20% 50VDC CER	28480	0160-0576
A9A2C10	0180-0491	5		CAPACITOR-FXD 10UF+-20% 25VDC TA	28480	0180-0491
A9A2C11	0180-0491	5		CAPACITOR-FXD 10UF+-20% 25VDC TA	28480	0180-0491
A9A2C12	0160-3879	7		CAPACITOR-FXD .01UF +-20% 100VDC CER	28480	0160-3879
A9A2C13	0180-0491	5		CAPACITOR-FXD 10UF+-20% 25VDC TA	28480	0180-0491
A9A2C14	0160-3879	7		CAPACITOR-FXD .01UF +-20% 100VDC CER	28480	0160-3879
A9A2C15	0160-3879	7		CAPACITOR-FXD .01UF +-20% 100VDC CER	28480	0160-3879
A9A2C16	0160-3879	7		CAPACITOR-FXD .01UF +-20% 100VDC CER	28480	0160-3879
A9A2C17	0160-3879	7		CAPACITOR-FXD .01UF +-20% 100VDC CER	28480	0160-3879
A9A2C18	0160-3879	7		CAPACITOR-FXD .01UF +-20% 100VDC CER	28480	0160-3879
A9A2C19	0160-3879	7		CAPACITOR-FXD .01UF +-20% 100VDC CER	28480	0160-3879
A9A2C20	0160-3879	7		CAPACITOR-FXD .01UF +-20% 100VDC CER	28480	0160-3879
A9A2C21	0160-3879	7		CAPACITOR-FXD .01UF +-20% 100VDC CER	28480	0160-3879
A9A2C22	0160-3879	7		CAPACITOR-FXD .01UF +-20% 100VDC CER	28480	0160-3879
A9A2C23	0160-3879	7		CAPACITOR-FXD .01UF +-20% 100VDC CER	28480	0160-3879
A9A2C24	0160-3879	7		CAPACITOR-FXD .01UF +-20% 100VDC CER	28480	0160-3879
A9A2C25	0160-3879	7		CAPACITOR-FXD .01UF +-20% 100VDC CER	28480	0160-3879
A9A2C26	0160-3879	7		CAPACITOR-FXD .01UF +-20% 100VDC CER	28480	0160-3879
A9A2C27	0160-3879	7		CAPACITOR-FXD .01UF +-20% 100VDC CER	28480	0160-3879
A9A2C28	0160-3879	7		CAPACITOR-FXD .01UF +-20% 100VDC CER	28480	0160-3879
A9A2C29	0160-3879	7		CAPACITOR-FXD .01UF +-20% 100VDC CER	28480	0160-3879
A9A2C30	0160-3879	7		CAPACITOR-FXD .01UF +-20% 100VDC CER	28480	0160-3879
A9A2C31	0160-4588	7	3	CAPACITOR-FXD 270PF +-5% 100VDC CER	28480	0160-4588
A9A2C32	0160-3879	7		CAPACITOR-FXD .01UF +-20% 100VDC CER	28480	0160-3879
A9A2C33	0160-3879	7		CAPACITOR-FXD .01UF +-20% 100VDC CER	28480	0160-3879
A9A2C34	0160-3879	7		CAPACITOR-FXD .01UF +-20% 100VDC CER	28480	0160-3879
A9A2C35	0160-3879	7		CAPACITOR-FXD .01UF +-20% 100VDC CER	28480	0160-3879
A9A2C36	0160-3879	7		CAPACITOR-FXD .01UF +-20% 100VDC CER	28480	0160-3879
A9A2C37	0160-3879	7		CAPACITOR-FXD .01UF +-20% 100VDC CER	28480	0160-3879
A9A2C38	0160-3879	7		CAPACITOR-FXD .01UF +-20% 100VDC CER	28480	0160-3879
A9A2C39	0160-0576	5		CAPACITOR-FXD .1UF +-20% 50VDC CER	28480	0160-0576
A9A2C40	0160-0576	5		CAPACITOR-FXD .1UF +-20% 50VDC CER	28480	0160-0576
A9A2C41	0160-0576	5		CAPACITOR-FXD .1UF +-20% 50VDC CER	28480	0160-0576
A9A2C42	0160-0576	5		CAPACITOR-FXD .1UF +-20% 50VDC CER	28480	0160-0576
A9A2C43	0160-0576	5		CAPACITOR-FXD .1UF +-20% 50VDC CER	28480	0160-0576
A9A2C44	0160-0576	5		CAPACITOR-FXD .1UF +-20% 50VDC CER	28480	0160-0576
A9A2C45	0180-0491	5		CAPACITOR-FXD 10UF+-20% 25VDC TA	28480	0180-0491
A9A2C46	0180-2618	2		CAPACITOR-FXD 33UF+-10% 10VDC TA	25088	D33GS1B10K
A9A2C47	0180-0491	5		CAPACITOR-FXD 10UF+-20% 25VDC TA	28480	0180-0491
A9A2C48	0160-0576	5		CAPACITOR-FXD .1UF +-20% 50VDC CER	28480	0160-0576
A9A2C49	0160-4527	4		CAPACITOR-FXD 56PF +-5% 200VDC CER 0+-30	28480	0160-4527
A9A2C50	0160-4527	4		CAPACITOR-FXD 56PF +-5% 200VDC CER 0+-30	28480	0160-4527
A9A2C51	0160-4527	4		CAPACITOR-FXD 56PF +-5% 200VDC CER 0+-30	28480	0160-4527
A9A2C52	0160-4527	4		CAPACITOR-FXD 56PF +-5% 200VDC CER 0+-30	28480	0160-4527
A9A2C53	0160-3879	7		CAPACITOR-FXD .01UF +-20% 100VDC CER	28480	0160-3879
A9A2C54	0180-0491	5		CAPACITOR-FXD 10UF+-20% 25VDC TA	28480	0180-0491
A9A2C55	0180-2618	2		CAPACITOR-FXD 33UF+-10% 10VDC TA	25088	D33GS1B10K
A9A2C56	0160-3879	7		CAPACITOR-FXD .01UF +-20% 100VDC CER	28480	0160-3879
A9A2C57	0160-0576	5		CAPACITOR-FXD .1UF +-20% 50VDC CER	28480	0160-0576
A9A2C58	0160-3879	7		CAPACITOR-FXD .01UF +-20% 100VDC CER	28480	0160-3879
A9A2C59	0180-2618	2		CAPACITOR-FXD 33UF+-10% 10VDC TA	25088	D33GS1B10K
A9A2C60	0160-3879	7		CAPACITOR-FXD .01UF +-20% 100VDC CER	28480	0160-3879
A9A2C61	0160-0576	5		CAPACITOR-FXD .1UF +-20% 50VDC CER	28480	0160-0576
A9A2C62	0160-0576	5		CAPACITOR-FXD .1UF +-20% 50VDC CER	28480	0160-0576
A9A2C63	0180-2618	2		CAPACITOR-FXD 33UF+-10% 10VDC TA	25088	D33GS1B10K
A9A2C64	0180-0491	5		CAPACITOR-FXD 10UF+-20% 25VDC TA	28480	0180-0491
A9A2C65	0160-0576	5		CAPACITOR-FXD .1UF +-20% 50VDC CER	28480	0160-0576

See introduction to this section for ordering information.

\* Indicates factory selected value

Table 6-2. Replaceable Parts

Reference Designation	HP Part Number	C D	Qty	Description	Mfr Code	Mfr Part Number
A9A2C66	0180-0491	5		CAPACITOR-FXD 10UF+-20% 25VDC TA	28480	0180-0491
A9A2C67	0160-0576	5		CAPACITOR-FXD .1UF +-20% 50VDC CER	28480	0160-0576
A9A2C68	0160-0576	5		CAPACITOR-FXD .1UF +-20% 50VDC CER	28480	0160-0576
A9A2C69	0180-0491	5		CAPACITOR-FXD 10UF+-20% 25VDC TA	28480	0180-0491
A9A2C70	0180-0491	5		CAPACITOR-FXD 10UF+-20% 25VDC TA	28480	0180-0491
A9A2C71	0160-0576	5		CAPACITOR-FXD .1UF +-20% 50VDC CER	28480	0160-0576
A9A2C72	0180-2618	2		CAPACITOR-FXD 33UF+-10% 10VDC TA	25088	D33GS1B10K
A9A2C73	0180-0491	5		CAPACITOR-FXD 10UF+-20% 25VDC TA	28480	0180-0491
A9A2C74	0160-0576	5		CAPACITOR-FXD .1UF +-20% 50VDC CER	28480	0160-0576
A9A2C75	0180-0491	5		CAPACITOR-FXD 10UF+-20% 25VDC TA	28480	0180-0491
A9A2C76	0160-0576	5		CAPACITOR-FXD .1UF +-20% 50VDC CER	28480	0160-0576
A9A2C77	0160-0158	9	1	CAPACITOR-FXD 5600PF +-10% 200VDC POLYE	28480	0160-0158
A9A2C78	0160-3879	7		CAPACITOR-FXD .01UF +-20% 100VDC CER	28480	0160-3879
A9A2C79	0160-3879	7		CAPACITOR-FXD .01UF +-20% 100VDC CER	28480	0160-3879
A9A2C80	0160-3879	7		CAPACITOR-FXD .01UF +-20% 100VDC CER	28480	0160-3879
A9A2C81	0160-5392	3	1	CAPACITOR-FXD 1500PF 400VDC	28480	0160-5392
A9A2C82	0160-3531	8		CAPACITOR-FXD 2UF +-5% 50VDC MET-POLYC	28480	0160-3531
A9A2C83	0160-3879	7		CAPACITOR-FXD .01UF +-20% 100VDC CER	28480	0160-3879
A9A2C84	0160-3879	7		CAPACITOR-FXD .01UF +-20% 100VDC CER	28480	0160-3879
A9A2C85	0180-2620	6		CAPACITOR-FXD 2.2UF+-10% 50VDC TA	25088	D2R2GS1B50K
A9A2C86	0180-2620	6		CAPACITOR-FXD 2.2UF+-10% 50VDC TA	25088	D2R2GS1B50K
A9A2CR1	1901-0050	3		DIODE-SWITCHING 80V 200MA 2NS DO-35	28480	1901-0050
A9A2CR2	1901-0050	3		DIODE-SWITCHING 80V 200MA 2NS DO-35	28480	1901-0050
A9A2CR3	1901-0539	3		DIODE-SM SIG SCHOTTKY	28480	1901-0539
A9A2CR4	1901-0539	3		DIODE-SM SIG SCHOTTKY	28480	1901-0539
A9A2CR5	1901-0539	3		DIODE-SM SIG SCHOTTKY	28480	1901-0539
A9A2CR6	1901-0050	3		DIODE-SWITCHING 80V 200MA 2NS DO-35	28480	1901-0050
A9A2CR7	1901-0539	3		DIODE-SM SIG SCHOTTKY	28480	1901-0539
A9A2CR8	1901-0539	3		DIODE-SM SIG SCHOTTKY	28480	1901-0539
A9A2CR9	1901-0050	3		DIODE-SWITCHING 80V 200MA 2NS DO-35	28480	1901-0050
A9A2CR10	1901-0050	3		DIODE-SWITCHING 80V 200MA 2NS DO-35	28480	1901-0050
A9A2CR11	1901-0050	3		DIODE-SWITCHING 80V 200MA 2NS DO-35	28480	1901-0050
A9A2DS1	1990-0451	5	1	LED-LAMP LUM-INT=300UCD IF=20MA-MAX	28480	5082-4468
A9A2FL1-FL13	9135-0214	4		FILTER-HIGH PASS PIN STYLE-TERMS	28480	9135-0214
A9A2J1	1251-8248	8		CONN-POST TYPE .100-PIN-SPCG 26-CONT	28480	1251-8248
A9A2J2	1251-5595	2		POLARIZING KEY-POST CONN	28480	1251-5595
A9A2J3	1250-1425	7		CONNECTOR-RF SMC M SGL-HOLE-RR 50-OHM	28480	1250-1425
A9A2J4	08642-20081	7		ELSTMR COND SMC	28480	08642-20081
A9A2J5	1250-1425	7		CONNECTOR-RF SMC M SGL-HOLE-RR 50-OHM	28480	1250-1425
A9A2J6	08642-20081	7		ELSTMR COND SMC	28480	08642-20081
A9A2L1	1250-1425	7		CONNECTOR-RF SMC M SGL-HOLE-RR 50-OHM	28480	1250-1425
A9A2L2	08642-20078	2		ELSTMR CON SMC D	28480	08642-20078
A9A2L3	1251-8759	6		CONN-POST TYPE .100-PIN-SPCG 11-CONT	28480	1251-8759
A9A2L4	1251-8758	5		CONN-POST TYPE .100-PIN-SPCG 8-CONT	28480	1251-8758
A9A2L5	9100-2262	3	2	INDUCTOR RF-CH-MLD 3.9UH 10% .105DX.26LG	28480	9100-2262
A9A2L6	9100-1623	8	4	INDUCTOR RF-CH-MLD 27UH 5% .166DX.385LG	28480	9100-1623
A9A2L7	9140-1087	2		INDUCTOR-FIXED 120-1300 HZ	28480	9140-1087
A9A2L8	9100-1623	8		INDUCTOR RF-CH-MLD 27UH 5% .166DX.385LG	28480	9100-1623
A9A2L9	9140-1087	2		INDUCTOR-FIXED 120-1300 HZ	28480	9140-1087
A9A2L10	9100-2262	3		INDUCTOR RF-CH-MLD 3.9UH 10% .105DX.26LG	28480	9100-2262
A9A2L11	9140-1087	2		INDUCTOR-FIXED 120-1300 HZ	28480	9140-1087
A9A2L12	9100-1623	8		INDUCTOR RF-CH-MLD 27UH 5% .166DX.385LG	28480	9100-1623
A9A2L13	9140-1087	2		INDUCTOR-FIXED 120-1300 HZ	28480	9140-1087
A9A2Q1	1854-0345	8		TRANSISTOR NPN 2N5179 SI TO-72 PD=200MW	04713	2N5179
A9A2Q2	1854-0345	8		TRANSISTOR NPN 2N5179 SI TO-72 PD=200MW	04713	2N5179
A9A2Q3	1854-0345	8		TRANSISTOR NPN 2N5179 SI TO-72 PD=200MW	04713	2N5179
A9A2Q4	1854-0345	8		TRANSISTOR NPN 2N5179 SI TO-72 PD=200MW	04713	2N5179
A9A2Q5	1853-0459	3		TRANSISTOR PNP SI PD=625MW FT=200MHZ	28480	1853-0459

See introduction to this section for ordering information.

\* Indicates factory selected value

Table 6-2. Replaceable Parts

Reference Designation	HP Part Number	C D	Qty	Description	Mfr Code	Mfr Part Number
A9A2Q6	1853-0459	3		TRANSISTOR PNP SI PD=625MW FT=200MHZ	28480	1853-0459
A9A2Q7	1853-0459	3		TRANSISTOR PNP SI PD=625MW FT=200MHZ	28480	1853-0459
A9A2Q8	1853-0459	3		TRANSISTOR PNP SI PD=625MW FT=200MHZ	28480	1853-0459
A9A2Q9	1853-0459	3		TRANSISTOR PNP SI PD=625MW FT=200MHZ	28480	1853-0459
A9A2Q10	1853-0459	3		TRANSISTOR PNP SI PD=625MW FT=200MHZ	28480	1853-0459
A9A2Q11	1854-0810	2		TRANSISTOR NPN SI PD=625MW FT=200MHZ	28480	1854-0810
A9A2Q12	1853-0405	9		TRANSISTOR PNP SI PD=300MW FT=850MHZ	04713	2N4209
A9A2Q13	1853-0405	9		TRANSISTOR PNP SI PD=300MW FT=850MHZ	04713	2N4209
A9A2Q14	1855-0049	1	1	TRANSISTOR-JFET DUAL N-CHAN D-MODE SI	28480	1855-0049
A9A2Q15	1853-0034	0	3	TRANSISTOR PNP SI TO-18 PD=360MW	28480	1853-0034
A9A2Q16	1854-0477	7		TRANSISTOR NPN 2N2222A SI TO-18 PD=500MW	04713	2N2222A
A9A2Q17	1854-0477	7		TRANSISTOR NPN 2N2222A SI TO-18 PD=500MW	04713	2N2222A
A9A2Q18	1854-0810	2		TRANSISTOR NPN SI PD=625MW FT=200MHZ	28480	1854-0810
A9A2Q19	1853-0281	9		TRANSISTOR PNP 2N2907A SI TO-18 PD=400MW	04713	2N2907A
A9A2Q20	1853-0281	9		TRANSISTOR PNP 2N2907A SI TO-18 PD=400MW	04713	2N2907A
A9A2Q21	1853-0034	0		TRANSISTOR PNP SI TO-18 PD=360MW	28480	1853-0034
A9A2Q22	1853-0034	0		TRANSISTOR PNP SI TO-18 PD=360MW	28480	1853-0034
A9A2Q23	1855-0276	6	3	TRANSISTOR J-FET 2N4416A N-CHAN D-MODE	01295	2N4416A
A9A2Q24	1854-0345	8		TRANSISTOR NPN 2N5179 SI TO-72 PD=200MW	04713	2N5179
A9A2Q25	1853-0281	9		TRANSISTOR PNP 2N2907A SI TO-18 PD=400MW	04713	2N2907A
A9A2Q26	1853-0281	9		TRANSISTOR PNP 2N2907A SI TO-18 PD=400MW	04713	2N2907A
A9A2Q27	1853-0281	9		TRANSISTOR PNP 2N2907A SI TO-18 PD=400MW	04713	2N2907A
A9A2Q28	1853-0281	9		TRANSISTOR PNP 2N2907A SI TO-18 PD=400MW	04713	2N2907A
A9A2Q29	1854-0215	1	3	TRANSISTOR NPN SI PD=350MW FT=300MHZ	04713	2N3904
A9A2Q30	1853-0281	9		TRANSISTOR PNP 2N2907A SI TO-18 PD=400MW	04713	2N2907A
A9A2Q31	1854-0215	1		TRANSISTOR NPN SI PD=350MW FT=300MHZ	04713	2N3904
A9A2Q32	1854-0215	1		TRANSISTOR NPN SI PD=350MW FT=300MHZ	04713	2N3904
A9A2Q33	1855-0277	7	2	TRANSISTOR J-FET 2N5268 P-CHAN D-MODE	04713	2N5268
A9A2Q34	1855-0276	6		TRANSISTOR J-FET 2N4416A N-CHAN D-MODE	01295	2N4416A
A9A2Q35	1855-0276	6		TRANSISTOR J-FET 2N4416A N-CHAN D-MODE	01295	2N4416A
A9A2Q36	1855-0277	7		TRANSISTOR J-FET 2N5268 P-CHAN D-MODE	04713	2N5268
A9A2R1	1810-0206	8	3	NETWORK-RES 8-SIP10.0K OHM X 7	01121	208A103
A9A2R2	0698-7244	7		RESISTOR 2.15K 1% .05W F TC=0+-100	24546	C3-1/8-T0-2151-F
A9A2R3	0698-7260	7		RESISTOR 10K 1% .05W F TC=0+-100	24546	C3-1/8-T0-1002-F
A9A2R4	0698-7248	1		RESISTOR 3.16K 1% .05W F TC=0+-100	24546	C3-1/8-T0-3161-F
A9A2R5	0698-7260	7		RESISTOR 10K 1% .05W F TC=0+-100	24546	C3-1/8-T0-1002-F
A9A2R6	0698-7262	9	2	RESISTOR 12.1K 1% .05W F TC=0+-100	24546	C3-1/8-T0-1212-F
A9A2R7	0698-7252	7		RESISTOR 4.64K 1% .05W F TC=0+-100	24546	C3-1/8-T0-4641-F
A9A2R8	0698-7248	1		RESISTOR 3.16K 1% .05W F TC=0+-100	24546	C3-1/8-T0-3161-F
A9A2R9	0698-7243	6		RESISTOR 1.96K 1% .05W F TC=0+-100	24546	C3-1/8-T0-1961-F
A9A2R10	0698-7209	4	4	RESISTOR 75 1% .05W F TC=0+-100	24546	C3-1/8-T0-75R0-F
A9A2R11	0757-0730	8		RESISTOR 750 1% .25W F TC=0+-100	24546	C5-1/4-T0-751-F
A9A2R12	0698-7188	8		RESISTOR 10 1% .05W F TC=0+-100	24546	C3-1/8-T0-10R-F
A9A2R13	0698-7216	3	2	RESISTOR 147 1% .05W F TC=0+-100	24546	C3-1/8-T0-147R-F
A9A2R14	0698-7236	7		RESISTOR 1K 1% .05W F TC=0+-100	24546	C3-1/8-T0-1001-F
A9A2R15	0698-7236	7		RESISTOR 1K 1% .05W F TC=0+-100	24546	C3-1/8-T0-1001-F
A9A2R16	0698-7209	4		RESISTOR 75 1% .05W F TC=0+-100	24546	C3-1/8-T0-75R0-F
A9A2R17	0757-0274	5		RESISTOR 1.21K 1% .125W F TC=0+-100	24546	C4-1/8-T0-1211-F
A9A2R18	0698-7212	9		RESISTOR 100 1% .05W F TC=0+-100	24546	C3-1/8-T0-100R-F
A9A2R19	0698-7226	5	2	RESISTOR 383 1% .05W F TC=0+-100	24546	C3-1/8-T0-383R-F
A9A2R20	0698-7260	7		RESISTOR 10K 1% .05W F TC=0+-100	24546	C3-1/8-T0-1002-F
A9A2R21	0698-7260	7		RESISTOR 10K 1% .05W F TC=0+-100	24546	C3-1/8-T0-1002-F
A9A2R22	0698-7260	7		RESISTOR 10K 1% .05W F TC=0+-100	24546	C3-1/8-T0-1002-F
A9A2R23	0698-7260	7		RESISTOR 10K 1% .05W F TC=0+-100	24546	C3-1/8-T0-1002-F
A9A2R24	0698-7260	7		RESISTOR 10K 1% .05W F TC=0+-100	24546	C3-1/8-T0-1002-F
A9A2R25	0698-7260	7		RESISTOR 10K 1% .05W F TC=0+-100	24546	C3-1/8-T0-1002-F
A9A2R26	0698-7212	9		RESISTOR 100 1% .05W F TC=0+-100	24546	C3-1/8-T0-100R-F
A9A2R27	0698-7260	7		RESISTOR 10K 1% .05W F TC=0+-100	24546	C3-1/8-T0-1002-F
A9A2R28	0698-7260	7		RESISTOR 10K 1% .05W F TC=0+-100	24546	C3-1/8-T0-1002-F
A9A2R29	0698-7260	7		RESISTOR 10K 1% .05W F TC=0+-100	24546	C3-1/8-T0-1002-F
A9A2R30	1810-0316	1	1	NETWORK-RES 16-DIP10.0K OHM X 8	01121	316B103
A9A2R31	1810-0206	8		NETWORK-RES 8-SIP10.0K OHM X 7	01121	208A103
A9A2R32	1810-0206	8		NETWORK-RES 8-SIP10.0K OHM X 7	01121	208A103
A9A2R33	0698-7260	7		RESISTOR 10K 1% .05W F TC=0+-100	24546	C3-1/8-T0-1002-F
A9A2R34	0698-7212	9		RESISTOR 100 1% .05W F TC=0+-100	24546	C3-1/8-T0-100R-F
A9A2R35	0698-7209	4		RESISTOR 75 1% .05W F TC=0+-100	24546	C3-1/8-T0-75R0-F

See introduction to this section for ordering information.

\* Indicates factory selected value

Table 6-2. Replaceable Parts

Reference Designation	HP Part Number	C D	Qty	Description	Mfr Code	Mfr Part Number
A9A2R36	0698-7206	1	4	RESISTOR 56.2 1% .05W F TC=0+-100	24546	C3-1/8-T0-56R2-F
A9A2R37	0698-7232	3		RESISTOR 681 1% .05W F TC=0+-100	24546	C3-1/8-T0-681R-F
A9A2R38	0698-7239	0		RESISTOR 1.33K 1% .05W F TC=0+-100	24546	C3-1/8-T0-1331-F
A9A2R39	0698-7204	9		RESISTOR 46.4 1% .05W F TC=0+-100	24546	C3-1/8-T0-46R4-F
A9A2R40	0698-7205	0		RESISTOR 51.1 1% .05W F TC=0+-100	24546	C3-1/8-T0-51R1-F
A9A2R41	0698-7209	4	12	RESISTOR 75 1% .05W F TC=0+-100	24546	C3-1/8-T0-75R0-F
A9A2R42	0698-7206	1		RESISTOR 56.2 1% .05W F TC=0+-100	24546	C3-1/8-T0-56R2-F
A9A2R43	0698-7232	3		RESISTOR 681 1% .05W F TC=0+-100	24546	C3-1/8-T0-681R-F
A9A2R44	0698-7239	0		RESISTOR 1.33K 1% .05W F TC=0+-100	24546	C3-1/8-T0-1331-F
A9A2R45	0698-7204	9		RESISTOR 46.4 1% .05W F TC=0+-100	24546	C3-1/8-T0-46R4-F
A9A2R46	0698-7228	7	9	RESISTOR 464 1% .05W F TC=0+-100	24546	C3-1/8-T0-464R-F
A9A2R47	0698-7204	9		RESISTOR 46.4 1% .05W F TC=0+-100	24546	C3-1/8-T0-46R4-F
A9A2R48	0698-7228	7		RESISTOR 464 1% .05W F TC=0+-100	24546	C3-1/8-T0-464R-F
A9A2R49	0698-7204	9		RESISTOR 46.4 1% .05W F TC=0+-100	24546	C3-1/8-T0-46R4-F
A9A2R50	0698-7228	7		RESISTOR 464 1% .05W F TC=0+-100	24546	C3-1/8-T0-464R-F
A9A2R51	0698-7205	0	7	RESISTOR 51.1 1% .05W F TC=0+-100	24546	C3-1/8-T0-51R1-F
A9A2R52	0698-7228	7		RESISTOR 464 1% .05W F TC=0+-100	24546	C3-1/8-T0-464R-F
A9A2R53	0698-7205	0		RESISTOR 51.1 1% .05W F TC=0+-100	24546	C3-1/8-T0-51R1-F
A9A2R54	0757-0421	4		RESISTOR 825 1% .125W F TC=0+-100	24546	C4-1/8-T0-825R-F
A9A2R55	0698-7219	6		RESISTOR 196 1% .05W F TC=0+-100	24546	C3-1/8-T0-196R-F
A9A2R56	0698-7253	8	1	RESISTOR 5.11K 1% .05W F TC=0+-100	24546	C3-1/8-T0-5111-F
A9A2R57	0698-7197	9		RESISTOR 23.7 1% .05W F TC=0+-100	24546	C3-1/8-T0-23R7-F
A9A2R58	0757-0421	4		RESISTOR 825 1% .125W F TC=0+-100	24546	C4-1/8-T0-825R-F
A9A2R59	0698-3150	6		RESISTOR 2.37K 1% .125W F TC=0+-100	24546	C4-1/8-T0-2371-F
A9A2R60	0698-7242	5		RESISTOR 1.78K 1% .05W F TC=0+-100	24546	C3-1/8-T0-1781-F
A9A2R61	0698-7232	3	9	RESISTOR 681 1% .05W F TC=0+-100	24546	C3-1/8-T0-681R-F
A9A2R62	0757-1094	9		RESISTOR 1.47K 1% .125W F TC=0+-100	24546	C4-1/8-T0-1471-F
A9A2R63	0698-7204	9		RESISTOR 46.4 1% .05W F TC=0+-100	24546	C3-1/8-T0-46R4-F
A9A2R64	0698-7262	9		RESISTOR 12.1K 1% .05W F TC=0+-100	24546	C3-1/8-T0-1212-F
A9A2R65	0698-7242	5		RESISTOR 1.78K 1% .05W F TC=0+-100	24546	C3-1/8-T0-1781-F
A9A2R66	0698-3152	8	6	RESISTOR 3.48K 1% .125W F TC=0+-100	24546	C4-1/8-T0-3481-F
A9A2R67	0698-7257	2		RESISTOR 7.5K 1% .05W F TC=0+-100	24546	C3-1/8-T0-7501-F
A9A2R68	0698-7231	2		RESISTOR 619 1% .05W F TC=0+-100	24546	C3-1/8-T0-619R-F
A9A2R69	0698-7253	8		RESISTOR 5.11K 1% .05W F TC=0+-100	24546	C3-1/8-T0-5111-F
A9A2R70	0698-7253	8		RESISTOR 5.11K 1% .05W F TC=0+-100	24546	C3-1/8-T0-5111-F
A9A2R71	0698-7232	3	2	RESISTOR 681 1% .05W F TC=0+-100	24546	C3-1/8-T0-681R-F
A9A2R72	0698-7204	9		RESISTOR 46.4 1% .05W F TC=0+-100	24546	C3-1/8-T0-46R4-F
A9A2R73	2100-3096	6		RESISTOR-TRMR 50K 10% C TOP-ADJ 17-TRN	32997	3292W-1-503
A9A2R74	0698-7260	7		RESISTOR 10K 1% .05W F TC=0+-100	24546	C3-1/8-T0-1002-F
A9A2R75	2100-3296	8		RESISTOR-TRMR 1K 10% C TOP-ADJ 17-TRN	28480	2100-3296
A9A2R76	2100-3096	6	3	RESISTOR-TRMR 50K 10% C TOP-ADJ 17-TRN	32997	3292W-1-503
A9A2R77	0698-7204	9		RESISTOR 46.4 1% .05W F TC=0+-100	24546	C3-1/8-T0-46R4-F
A9A2R78	0698-7193	5		RESISTOR 16.2 1% .05W F TC=0+-100	24546	C3-1/8-T0-16R2-F
A9A2R79	0698-7204	9		RESISTOR 46.4 1% .05W F TC=0+-100	24546	C3-1/8-T0-46R4-F
A9A2R80	0698-7243	6		RESISTOR 1.96K 1% .05W F TC=0+-100	24546	C3-1/8-T0-1961-F
A9A2R81	0698-7236	7	7	RESISTOR 1K 1% .05W F TC=0+-100	24546	C3-1/8-T0-1001-F
A9A2R82	0698-7250	5		RESISTOR 3.83K 1% .05W F TC=0+-100	24546	C3-1/8-T0-3831-F
A9A2R83	0698-7243	6		RESISTOR 1.96K 1% .05W F TC=0+-100	24546	C3-1/8-T0-1961-F
A9A2R84	0698-7236	7		RESISTOR 1K 1% .05W F TC=0+-100	24546	C3-1/8-T0-1001-F
A9A2R85	0698-7250	5		RESISTOR 3.83K 1% .05W F TC=0+-100	24546	C3-1/8-T0-3831-F
A9A2R86	0698-7243	6	1	RESISTOR 1.96K 1% .05W F TC=0+-100	24546	C3-1/8-T0-1961-F
A9A2R87	0698-7236	7		RESISTOR 1K 1% .05W F TC=0+-100	24546	C3-1/8-T0-1001-F
A9A2R88	0698-7250	5		RESISTOR 3.83K 1% .05W F TC=0+-100	24546	C3-1/8-T0-3831-F
A9A2R89	0698-7260	7		RESISTOR 10K 1% .05W F TC=0+-100	24546	C3-1/8-T0-1002-F
A9A2R90	0699-0073	8		RESISTOR 10M 1% .125W F TC=0+-150	28480	0699-0073
A9A2R91	0698-7212	9	1	RESISTOR 100 1% .05W F TC=0+-100	24546	C3-1/8-T0-100R-F
A9A2R92	0698-8961	7		RESISTOR 909K 1% .125W F TC=0+-100	28480	0698-8961
A9A2R93	0698-7254	9		RESISTOR 5.62K 1% .05W F TC=0+-100	24546	C3-1/8-T0-5621-F
A9A2R94	0698-7243	6		RESISTOR 1.96K 1% .05W F TC=0+-100	24546	C3-1/8-T0-1961-F
A9A2R95	2100-3288	8		RESISTOR-TRMR 50 20% C TOP-ADJ 17-TRN	28480	2100-3288
A9A2R96	0698-7258	3	7	RESISTOR 8.25K 1% .05W F TC=0+-100	24546	C3-1/8-T0-8251-F
A9A2R97	0698-7238	9		RESISTOR 1.21K 1% .05W F TC=0+-100	24546	C3-1/8-T0-1211-F
A9A2R98	0698-7260	7		RESISTOR 10K 1% .05W F TC=0+-100	24546	C3-1/8-T0-1002-F
A9A2R99	0698-7260	7		RESISTOR 10K 1% .05W F TC=0+-100	24546	C3-1/8-T0-1002-F
A9A2R100	0698-7252	7		RESISTOR 4.64K 1% .05W F TC=0+-100	24546	C3-1/8-T0-4641-F

See introduction to this section for ordering information.

\* Indicates factory selected value



Table 6-2. Replaceable Parts

Reference Designation	HP Part Number	C D	Qty	Description	Mfr Code	Mfr Part Number
A9A2R101	0698-7193	5		RESISTOR 16.2 1% .05W F TC=0+-100	24546	C3-1/8-T0-16R2-F
A9A2R102	0698-7193	5		RESISTOR 16.2 1% .05W F TC=0+-100	24546	C3-1/8-T0-16R2-F
A9A2R103	0698-7228	7		RESISTOR 46.4 1% .05W F TC=0+-100	24546	C3-1/8-T0-46R4-F
A9A2R104	0698-7268	5		RESISTOR 21.5K 1% .05W F TC=0+-100	24546	C3-1/8-T0-2152-F
A9A2R105	0698-7204	9		RESISTOR 46.4 1% .05W F TC=0+-100	24546	C3-1/8-T0-46R4-F
A9A2R106	0698-7236	7		RESISTOR 1K 1% .05W F TC=0+-100	24546	C3-1/8-T0-1001-F
A9A2R107	0698-7243	6		RESISTOR 1.96K 1% .05W F TC=0+-100	24546	C3-1/8-T0-1961-F
A9A2R108	0698-7204	9		RESISTOR 46.4 1% .05W F TC=0+-100	24546	C3-1/8-T0-46R4-F
A9A2R109	0698-7234	5		RESISTOR 825 1% .05W F TC=0+-100	24546	C3-1/8-T0-825R-F
A9A2R110	0698-7204	9		RESISTOR 46.4 1% .05W F TC=0+-100	24546	C3-1/8-T0-46R4-F
A9A2R111	0698-7229	8		RESISTOR 511 1% .05W F TC=0+-100	24546	C3-1/8-T0-511R-F
A9A2R112	0698-7229	8		RESISTOR 511 1% .05W F TC=0+-100	24546	C3-1/8-T0-511R-F
A9A2R113	0698-7256	1		RESISTOR 6.81K 1% .05W F TC=0+-100	24546	C3-1/8-T0-6811-F
A9A2R114	0698-7204	9		RESISTOR 46.4 1% .05W F TC=0+-100	24546	C3-1/8-T0-46R4-F
A9A2R115	0698-7266	3	1	RESISTOR 17.8K 1% .05W F TC=0+-100	24546	C3-1/8-T0-1782-F
A9A2R116	0698-7236	7		RESISTOR 1K 1% .05W F TC=0+-100	24546	C3-1/8-T0-1001-F
A9A2R117	0698-7236	7		RESISTOR 1K 1% .05W F TC=0+-100	24546	C3-1/8-T0-1001-F
A9A2R118	0698-7284	5		RESISTOR 100K 1% .05W F TC=0+-100	24546	C3-1/8-T0-1003-F
A9A2R119	0698-7284	5		RESISTOR 100K 1% .05W F TC=0+-100	24546	C3-1/8-T0-1003-F
A9A2R120	0698-7259	4		RESISTOR 9.09K 1% .05W F TC=0+-100	24546	C3-1/8-T0-9091-F
A9A2R121	0698-7236	7		RESISTOR 1K 1% .05W F TC=0+-100	24546	C3-1/8-T0-1001-F
2427A TO 2636A A9A2R122				NOT ASSIGNED		
2637A AND ABOVE A9A2A122	0699-1391	5	1	RESISTOR 10K 1% .125W F TC=0+-100	28480	0699-1391
A9A2TP1-TP23	0360-0535	0		TERMINAL TEST POINT PCB	00000	ORDER BY DESCRIPTION
A9A2U1	1820-1197	9		IC GATE TTL LS NAND QUAD 2-INP	01295	SN74LS00N
A9A2U2	1820-0817	8	2	IC FF ECL D-M/S DUAL	04713	MC10131P
A9A2U3	1820-0683	6	2	IC INV TTL S HEX 1-INP	01295	SN74S04N
A9A2U4	1820-0629	0	5	IC FF TTL S J-K NEG-EDGE-TRIG	01295	SN74S112N
A9A2U5	1820-0629	0		IC FF TTL S J-K NEG-EDGE-TRIG	01295	SN74S112N
A9A2U6	1820-0668	7	6	IC BFR TTL NON-INV HEX 1-INP	01295	SN7407N
A9A2U7	1820-1216	3	2	IC DCDR TTL LS 3-T0-8-LINE 3-INP	01295	SN74LS138N
A9A2U8	1820-1858	9		IC FF TTL LS D-TYPE OCTL	01295	SN74LS377N
A9A2U9	1818-3460	8	1	IC ROM 2048X8	28480	1818-3460
	1200-0565	9	1	SOCKET-IC 24-CONT DIP-SLDR	28480	1200-0565
A9A2U10	1820-1196	8	3	IC FF TTL LS D-TYPE POS-EDGE-TRIG COM	01295	SN74LS174N
A9A2U11	1820-1279	8	2	IC CNTR TTL LS DECD UP/DOWN SYNCHRO	01295	SN74LS190N
A9A2U12	1820-1144	6	3	IC GATE TTL LS NOR QUAD 2-INP	01295	SN74LS02N
A9A2U13	1820-1212	9		IC FF TTL LS J-K NEG-EDGE-TRIG	01295	SN74LS112AN
A9A2U14	1820-0683	6		IC INV TTL S HEX 1-INP	01295	SN74S04N
A9A2U15	1820-1112	8		IC FF TTL LS D-TYPE POS-EDGE-TRIG	01295	SN74LS74AN
A9A2U16	1820-0629	0		IC FF TTL S J-K NEG-EDGE-TRIG	01295	SN74S112N
A9A2U17	1820-0629	0		IC FF TTL S J-K NEG-EDGE-TRIG	01295	SN74S112N
A9A2U18	1820-1416	5		IC SCHMITT-TRIG TTL LS INV HEX 1-INP	01295	SN74LS14N
A9A2U19	1820-1112	8		IC FF TTL LS D-TYPE POS-EDGE-TRIG	01295	SN74LS74AN
A9A2U20	1820-2004	9	1	IC MISC NMOS	28480	1820-2004
	08642-00111	2	1	FOAM IC	28480	08642-00111
	1200-1121	5	1	SOCKET-IC DIP PC	28480	1200-1121
A9A2U21	1820-1196	8		IC FF TTL LS D-TYPE POS-EDGE-TRIG COM	01295	SN74LS174N
A9A2U22	1820-1279	8		IC CNTR TTL LS DECD UP/DOWN SYNCHRO	01295	SN74LS190N
A9A2U23	1820-1197	9		IC GATE TTL LS NAND QUAD 2-INP	01295	SN74LS00N
A9A2U24	1820-0629	0		IC FF TTL S J-K NEG-EDGE-TRIG	01295	SN74S112N
A9A2U25	1820-1197	9		IC GATE TTL LS NAND QUAD 2-INP	01295	SN74LS00N
A9A2U26	1820-1144	6		IC GATE TTL LS NOR QUAD 2-INP	01295	SN74LS02N
A9A2U27	1820-1212	9		IC FF TTL LS J-K NEG-EDGE-TRIG	01295	SN74LS112AN
A9A2U28	1820-1212	9		IC FF TTL LS J-K NEG-EDGE-TRIG	01295	SN74LS112AN
A9A2U29	1820-1251	6		IC CNTR TTL LS DECD ASYNCHRO	01295	SN74LS196N
A9A2U30	1826-0141	3	1	IC COMPARATOR GP DUAL 14-DIP-C PKG	27014	LM319J
A9A2U31	1820-0817	8		IC FF ECL D-M/S DUAL	04713	MC10131P
A9A2U32	1826-1045	8	1	IC OP AMP H-SLEW-RATE 8-DIP-C PKG	28480	1826-1045
A9A2U33	1826-0371	1		IC OP AMP LOW-BIAS-H-IMPED TO-99 PKG	27014	LF256H
A9A2U34	1810-0294	4	1	NETWORK-RESISTOR 16 PIN DIP; RES	28480	1810-0294
A9A2U35	1858-0032	8	1	TRANSISTOR ARRAY 14-PIN PLSTC DIP	31585	CA3146E
A9A2U36	1820-1196	8		IC FF TTL LS D-TYPE POS-EDGE-TRIG COM	01295	SN74LS174N
A9A2U37	1826-0371	1		IC OP AMP LOW-BIAS-H-IMPED TO-99 PKG	27014	LF256H
2427A TO 2738A A9A2U38	1826-0043	4		IC OP AMP GP TO-99 PKG	31585	CA307T
2809A AND ABOVE A9A2U38	1826-0989	7		IC OP AMP GP 8-DIP-C PKG	28480	1826-0989

See introduction to this section for ordering information.

\* Indicates factory selected value

Table 6-2. Replaceable Parts

Reference Designation	HP Part Number	C D	Qty	Description	Mfr Code	Mfr Part Number
A9A2VR1	1902-0946	8	1	DIODE-ZNR 3.3V 5% DO-35 PD=.4W TC=-.039%	28480	1902-0946
A9A2VR2	1902-0680	7	5	DIODE-ZNR 1N827 6.2V 5% DO-7 PD=.4W	24046	1N827
A9A2VR3	1902-0680	7		DIODE-ZNR 1N827 6.2V 5% DO-7 PD=.4W	24046	1N827
A9A2VR4	1902-0947	9	1	DIODE-ZNR 3.6V 5% DO-35 PD=.4W TC=-.036%	28480	1902-0947
A9A2VR5	1902-0680	7		DIODE-ZNR 1N827 6.2V 5% DO-7 PD=.4W	24046	1N827

See introduction to this section for ordering information.

\* Indicates factory selected value

Table 6-2. Replaceable Parts

Reference Designation	HP Part Number	C D	Qty	Description	Mfr Code	Mfr Part Number
<p><b>A10</b></p> <p>A10</p>	<p>0960-0448</p> <p>0362-0265</p>	<p>6</p> <p>7</p>	<p>1</p> <p>7</p>	<p>LINE POWER ASSEMBLY</p> <p>LINE MODULE-FILTERED CONNECTOR-SGL CONT SKT 1.14-MM-BSC-SZ</p>	<p>05245</p> <p>28480</p>	<p>F1927</p> <p>0362-0265</p>

See introduction to this section for ordering information.

\* Indicates factory selected value



Table 6-2. Replaceable Parts

Reference Designation	HP Part Number	C D	Qty	Description	Mfr Code	Mfr Part Number
<b>A11</b>						
A11	08642-60896	6	1	REFERENCE LOOP MODULE	28480	08642-60896
A11	08642-69896	4	1	REFERENCE LOOP MODULE (RESTORED)	28480	08642-69896
A11FL1	08642-80012	0		FLTR LP 7POS BKT	28480	08642-80012
A11FL2	9135-0233	7	3	FLTR LP .3G 100V	28480	9135-0233
A11FL3	9135-0233	7		FLTR LP .3G 100V	28480	9135-0233
A11MP1	08642-20009	9	1	COVER REF PHASE DETECTOR	28480	08642-20009
A11MP2	08642-40057	0	2	GASKET FEEDTHRU	28480	08642-40058
A11MP3	08642-00044	0	4	CVR MXR ACCES	28480	08642-00044
A11MP4	0515-1101	7		SCREW-MACH M4 X 0.7 8MM-LG 90-DEG-FLH-HD (ATTACH ACCESS COVERS TO COVER)	28480	0515-1101
A11MP5	08642-20010	2	1	BASE REF LOOP	28480	08642-20010
A11MP6	3050-0990	7	2	WASHER-FL NM NO. 000 .04-IN-ID .25-IN-OD	28480	3050-0990
A11MP7	08642-00001	9		GASKET 7 P FILTR	28480	08642-00001
A11MP8	0515-1521	5		SCREW-MACH M3 X 0.5 5MM-LG 90-DEG-FLH-HD (ATTACH FILTER TO BASE)	28480	0515-1521
A11MP9	08642-00075	7	1	FOAM-COND (1000 TO 5000 OHMS PER SQ)	28480	08642-00075
A11MP11	08642-20011	3	1	COVER REF VCO/MIXER/SPLITTER	28480	08642-20011
A11MP12	11661-20046	4	2	SHIELD-POLYIRON	28480	11661-20046
A11MP13	08642-40078	4	1	SHIELD POLYIRON	28480	08642-40078
A11MP14	0515-0684	9		SCREW-MACH M4 X 0.7 6MM-LG PAN-HD (ATTACH BOARDS TO BASE)	28480	0515-0684
A11MP15	0515-0381	3		SCREW-MACH M4 X 0.7 10MM-LG PAN-HD (ATTACH COVERS TO BASE)	00000	ORDER BY DESCRIPTION
A11MP16	8160-0472	8		RFI ROUND STRIP BE-CU SN-PL .093-IN-OD (SPIRA SHIELD)	28480	8160-0472
A11MP17	08642-00050	8	3	SLIDE-MODUL 57R4 (FRONT)	28480	08642-00050
A11MP18	08642-00049	5	6	SLIDE-MDL469R56 (REAR)	28480	08642-00049
A11MP19	0515-1102	8		SCREW-MACH M3 X 0.5 8MM-LG 90-DEG-FLH-HD (ATTACH MODULE SLIDES TO BASE)	28480	0515-1102
A11MP20	08642-80067	5	1	LABEL-REF 60004	28480	08642-80067
A11W1	5061-4806	7	1	CBL-COAX 925 (A11A1J2 TO A11A3J3)	28480	5061-4806
A11W2	08642-60043	5	1	CBL-COAX 923 (A11A1J4 TO A11A2J1)	28480	08642-60043
A11W3	08642-20066	8	2	CABLE SR JUMPER (A11A2J3 TO A11A3J6)	28480	08642-20066

See introduction to this section for ordering information.

\* Indicates factory selected value



Table 6-2. Replaceable Parts

Reference Designation	HP Part Number	C D	Qty	Description	Mfr Code	Mfr Part Number
<b>A11A1</b>	08642-60106	1	1	REFERENCE PHASE DETECTOR ASSEMBLY	28480	08642-60106
A11A1C1	0180-0089	7	2	CAPACITOR-FXD 10UF+50-10% 150VDC AL	56289	30D106F150DD2
A11A1C2	0160-0168	1	2	CAPACITOR-FXD .1UF +-10% 200VDC POLYE	28480	0160-0168
A11A1C3	0160-4535	4		CAPACITOR-FXD 1UF +-10% 50VDC CER	28480	0160-4535
A11A1C4	0160-4040	6		CAPACITOR-FXD 1000PF +-5% 100VDC CER	28480	0160-4040
A11A1C5	0160-4040	6		CAPACITOR-FXD 1000PF +-5% 100VDC CER	28480	0160-4040
A11A1C6	0160-0576	5		CAPACITOR-FXD .1UF +-20% 50VDC CER	28480	0160-0576
A11A1C7	0160-0576	5		CAPACITOR-FXD .1UF +-20% 50VDC CER	28480	0160-0576
A11A1C8	0160-4040	6		CAPACITOR-FXD 1000PF +-5% 100VDC CER	28480	0160-4040
A11A1C9	0160-3879	7		CAPACITOR-FXD .01UF +-20% 100VDC CER	28480	0160-3879
A11A1C10	0160-4524	1	3	CAPACITOR-FXD 24PF +-5% 200VDC CER 0+-30	51642	200-200-NP0-240J
A11A1C11	0160-4526	3	4	CAPACITOR-FXD 42PF +-5% 200VDC CER 0+-30	28480	0160-4526
A11A1C12	0160-4524	1		CAPACITOR-FXD 24PF +-5% 200VDC CER 0+-30	51642	200-200-NP0-240J
A11A1C13	0160-3879	7		CAPACITOR-FXD .01UF +-20% 100VDC CER	28480	0160-3879
A11A1C14	0160-4389	6	17	CAPACITOR-FXD 100PF +-5PF 200VDC CER	28480	0160-4389
A11A1C15	0160-0576	5		CAPACITOR-FXD .1UF +-20% 50VDC CER	28480	0160-0576
A11A1C16	0160-4040	6		CAPACITOR-FXD 1000PF +-5% 100VDC CER	28480	0160-4040
A11A1C17	0160-4535	4		CAPACITOR-FXD 1UF +-10% 50VDC CER	28480	0160-4535
A11A1C18	0160-4040	6		CAPACITOR-FXD 1000PF +-5% 100VDC CER	28480	0160-4040
A11A1C19	0160-0576	5		CAPACITOR-FXD .1UF +-20% 50VDC CER	28480	0160-0576
A11A1C20	0160-3879	7		CAPACITOR-FXD .01UF +-20% 100VDC CER	28480	0160-3879
A11A1C21	0160-4040	6		CAPACITOR-FXD 1000PF +-5% 100VDC CER	28480	0160-4040
A11A1C22	0160-3879	7		CAPACITOR-FXD .01UF +-20% 100VDC CER	28480	0160-3879
A11A1C23	0160-0576	5		CAPACITOR-FXD .1UF +-20% 50VDC CER	28480	0160-0576
A11A1C24				NOT ASSIGNED		
A11A1C25	0160-4040	6		CAPACITOR-FXD 1000PF +-5% 100VDC CER	28480	0160-4040
A11A1C26	0160-5957	6		CAPACITOR-FXD 47PF +-5% 50VDC CER 0+-30	28480	0160-5957
A11A1C27	0160-5959	8	2	CAPACITOR-FXD 33PF +-5% 50VDC CER 0+-30	28480	0160-5959
A11A1C28	0160-3874	2		CAPACITOR-FXD 10PF +-5PF 200VDC CER	28480	0160-3874
A11A1C29	0160-5957	6		CAPACITOR-FXD 47PF +-5% 50VDC CER 0+-30	28480	0160-5957
A11A1C30	0160-4498	8		CAPACITOR-FXD 5.6PF +-5PF 200VDC CER	28480	0160-4498
A11A1C31	0160-5961	2		CAPACITOR-FXD 22PF +-5% 50VDC CER 0+-30	28480	0160-5961
A11A1C32	0160-4768	5		CAPACITOR-FXD 470PF +-5% 100VDC CER	28480	0160-4768
<b>2731A TO 2735A</b>						
<b>A11A1C33</b>	0160-4387	4		CAPACITOR-FXD 47PF +-5% 200VDC CER 0+-30	28480	0160-4387
<b>A11A1C34</b>	0121-0449	9	2	CAPACITOR-V TRMR-CER 3.5-10PF 63V PC-MTG	28480	0121-0449
<b>2736A AND ABOVE</b>						
<b>A11A1C33</b>	0160-4765	2		CAPACITOR-FXD 36PF+-5% 200VDC CER 0+-30	28480	0160-4765
<b>A11A1C34</b>	0160-0461	5		CAPACITOR-V TRMR-CER 6-22PF 63V PC-MTG	28480	0121-0461
A11A1C35	0160-4768	5		CAPACITOR-FXD 470PF +-5% 100VDC CER	28480	0160-4768
A11A1C36	0160-5038	4	2	CAPACITOR-FXD 3300PF +-10% 100VDC CER	28480	0160-5038
A11A1C37	0160-4835	7		CAPACITOR-FXD .1UF +-10% 50VDC CER	28480	0160-4835
A11A1C38	0160-4535	4		CAPACITOR-FXD 1UF +-10% 50VDC CER	28480	0160-4535
A11A1C39	0160-4835	7		CAPACITOR-FXD .1UF +-10% 50VDC CER	28480	0160-4835
A11A1C40	0160-0576	5		CAPACITOR-FXD .1UF +-20% 50VDC CER	28480	0160-0576
A11A1C41	0160-4832	4		CAPACITOR-FXD .01UF +-10% 100VDC CER	28480	0160-4832
A11A1C42	0160-3875	3		CAPACITOR-FXD 22PF +-5% 200VDC CER 0+-30	28480	0160-3875
A11A1C43	0160-4832	4		CAPACITOR-FXD .01UF +-10% 100VDC CER	28480	0160-4832
A11A1C44	0160-4801	7		CAPACITOR-FXD 100PF +-5% 100VDC CER	28480	0160-4801
A11A1C45	0160-4801	7		CAPACITOR-FXD 100PF +-5% 100VDC CER	28480	0160-4801
A11A1C46	0160-4822	2		CAPACITOR-FXD 1000PF +-5% 100VDC CER	28480	0160-4822
A11A1C47	0160-4835	7		CAPACITOR-FXD .1UF +-10% 50VDC CER	28480	0160-4835
A11A1C48	0160-4835	7		CAPACITOR-FXD .1UF +-10% 50VDC CER	28480	0160-4835
A11A1C49	0180-0491	5		CAPACITOR-FXD 10UF+-20% 25VDC TA	28480	0180-0491
A11A1C50	0160-0576	5		CAPACITOR-FXD .1UF +-20% 50VDC CER	28480	0160-0576
A11A1C51	0180-0491	5		CAPACITOR-FXD 10UF+-20% 25VDC TA	28480	0180-0491
A11A1C52	0180-0491	5		CAPACITOR-FXD 10UF+-20% 25VDC TA	28480	0180-0491
A11A1C53	0160-3879	7		CAPACITOR-FXD .01UF +-20% 100VDC CER	28480	0160-3879
A11A1C54	0160-4835	7		CAPACITOR-FXD .1UF +-10% 50VDC CER	28480	0160-4835
A11A1C55	0160-3879	7		CAPACITOR-FXD .01UF +-20% 100VDC CER	28480	0160-3879
A11A1C56	0160-3879	7		CAPACITOR-FXD .01UF +-20% 100VDC CER	28480	0160-3879
A11A1C57	0160-0576	5		CAPACITOR-FXD .1UF +-20% 50VDC CER	28480	0160-0576
A11A1C58	0160-4547	8	4	CAPACITOR-FXD 150PF +-5% 200VDC CER	28480	0160-4547
A11A1C59	0160-0576	5		CAPACITOR-FXD .1UF +-20% 50VDC CER	28480	0160-0576
A11A1C60	0160-0576	5		CAPACITOR-FXD .1UF +-20% 50VDC CER	28480	0160-0576
A11A1C61	0160-0576	5		CAPACITOR-FXD .1UF +-20% 50VDC CER	28480	0160-0576
A11A1C62	0160-0576	5		CAPACITOR-FXD .1UF +-20% 50VDC CER	28480	0160-0576
A11A1C63	0160-5957	6		CAPACITOR-FXD 47PF +-5% 50VDC CER 0+-30	28480	0160-5957
A11A1C64	0160-5957	6		CAPACITOR-FXD 47PF +-5% 50VDC CER 0+-30	28480	0160-5957
A11A1C65	0160-5959	8		CAPACITOR-FXD 33PF +-5% 50VDC CER 0+-30	28480	0160-5959

See introduction to this section for ordering information.

\* Indicates factory selected value

Table 6-2. Replaceable Parts

Reference Designation	HP Part Number	C D	Qty	Description	Mfr Code	Mfr Part Number
A11A1CR1	1901-1085	6	4	DIODE-SM SIG SCHOTTKY	28480	1901-1085
A11A1CR2	1901-1085	6		DIODE-SM SIG SCHOTTKY	28480	1901-1085
A11A1CR3	1901-0050	3		DIODE-SWITCHING 80V 200MA 2NS DO-35	28480	1901-0050
A11A1CR4	1901-0050	3		DIODE-SWITCHING 80V 200MA 2NS DO-35	28480	1901-0050
A11A1CR5	1901-0050	3		DIODE-SWITCHING 80V 200MA 2NS DO-35	28480	1901-0050
A11A1DS1	1990-1110	5	2	LED-LAMP LUM-INT=1.5MCD IF=20MA-MAX	28480	1990-1110
A11A1FL1	9135-0214	4		FILTER-HIGH PASS PIN STYLE-TERMS	28480	9135-0214
A11A1FL2	9135-0214	4		FILTER-HIGH PASS PIN STYLE-TERMS	28480	9135-0214
A11A1FL3	9135-0214	4		FILTER-HIGH PASS PIN STYLE-TERMS	28480	9135-0214
A11A1FL4	9135-0214	4		FILTER-HIGH PASS PIN STYLE-TERMS	28480	9135-0214
A11A1FL5	9135-0214	4		FILTER-HIGH PASS PIN STYLE-TERMS	28480	9135-0214
A11A1FL6	9135-0214	4		FILTER-HIGH PASS PIN STYLE-TERMS	28480	9135-0214
A11A1FL7	9135-0214	4		FILTER-HIGH PASS PIN STYLE-TERMS	28480	9135-0214
A11A1FL8	9135-0214	4		FILTER-HIGH PASS PIN STYLE-TERMS	28480	9135-0214
A11A1J1	1251-8105	6	3	CONN-POST TYPE .100-PIN-SPCG 16-CONT	28480	1251-8105
	1251-5595	2		POLARIZING KEY-POST CONN	28480	1251-5595
A11A1J2	1250-1425	7		CONNECTOR-RF SMC M SGL-HOLE-RR 50-OHM	28480	1250-1425
	08642-20081	7	7	ELSTMR COND SMC	28480	08642-20081
A11A1J3	1250-1425	7		CONNECTOR-RF SMC M SGL-HOLE-RR 50-OHM	28480	1250-1425
	08642-20081	7		ELSTMR COND SMC	28480	08642-20081
A11A1J4	1250-1425	7	7	CONNECTOR-RF SMC M SGL-HOLE-RR 50-OHM	28480	1250-1425
	08642-20081	7		ELSTMR COND SMC	28480	08642-20081
A11A1J5	1252-0318	9	6	CONN POST SKT 2	28480	1252-0318
A11A1J6	1252-0318	9		CONN POST SKT 2	28480	1252-0318
A11A1J7	1251-8758	5		CONN-POST TYPE .100-PIN-SPCG 8-CONT	28480	1251-8758
A11A1L1	9140-0528	4	2	INDUCTOR RF-CH-MLD 120NH 5% .105DX.26LG	28480	9140-0528
A11A1L2	9140-0400	1		INDUCTOR RF-CH-MLD 8.2UH 5% .166DX.385LG	28480	9140-0400
A11A1L3	9100-1631	8	3	INDUCTOR RF-CH-MLD 56UH 5% .166DX.385LG	28480	9100-1631
A11A1L4	9140-0531	9		INDUCTOR RF-CH-MLD 1UH 5% .105DX.26LG	28480	9140-0531
A11A1L5	9135-0078	8	8	INDUCTOR RF-CH-MLD 82NH 7% .102DX.26LG	28480	9135-0078
A11A1L6	9140-0531	9	9	INDUCTOR RF-CH-MLD 1UH 5% .105DX.26LG	28480	9140-0531
A11A1L7	9135-0078	8		INDUCTOR RF-CH-MLD 82NH 7% .102DX.26LG	28480	9135-0078
A11A1L8	9140-0531	9		INDUCTOR RF-CH-MLD 1UH 5% .105DX.26LG	28480	9140-0531
A11A1L9	9135-0079	9	9	INDUCTOR RF-CH-MLD 100NH 5% .102DX.26LG	28480	9135-0079
A11A1L10	9140-0517	1		2	INDUCTOR RF-CH-MLD 180NH 5% .105DX.26LG	28480
A11A1L11	9140-0517	1	1	INDUCTOR RF-CH-MLD 180NH 5% .105DX.26LG	28480	9140-0517
A11A1L12	9140-0528	4		INDUCTOR RF-CH-MLD 120NH 5% .105DX.26LG	28480	9140-0528
A11A1L13	9140-0531	9		INDUCTOR RF-CH-MLD 1UH 5% .105DX.26LG	28480	9140-0531
A11A1L14	9140-1087	2		INDUCTOR-FIXED 120-1300 HZ	28480	9140-1087
A11A1L15	9140-0299	6		2	INDUCTOR RF-CH-MLD 820NH 5% .105DX.26LG	28480
A11A1L16	9140-0137	1	1	INDUCTOR RF-CH-MLD 1MH 5% .2DX.45LG Q=60	28480	9140-0137
A11A1L17	9140-0507	9	3	INDUCTOR RF-CH-MLD 56UH 5% .105DX.26LG	28480	9140-0507
A11A1Q1	1854-1008	2	4	TRANSISTOR NPN SI PD=600MW FT=2GHZ	28480	1854-1008
A11A1Q2	1854-0720	3		TRANSISTOR NPN SI PD=500MW FT=4GHZ	28480	1854-0720
A11A1Q3	1854-0720	3		TRANSISTOR NPN SI PD=500MW FT=4GHZ	28480	1854-0720
A11A1Q4	1853-0459	3		TRANSISTOR PNP SI PD=625MW FT=200MHZ	28480	1853-0459
A11A1Q5				NOT ASSIGNED		
A11A1Q6	1854-0720	3	6	TRANSISTOR NPN SI PD=500MW FT=4GHZ	28480	1854-0720
A11A1Q7	1854-0637	1		TRANSISTOR NPN 2N2219A SI TO-5 PD=800MW	01295	2N2219A
	1200-0173	5		INSULATOR-XSTR DAP-GL	28480	1200-0173
	1205-0011	0	7	HEAT SINK TO-5/TO-39-CS	28480	1205-0011
A11A1Q8	1854-0637	1		TRANSISTOR NPN 2N2219A SI TO-5 PD=800MW	01295	2N2219A
	1200-0173	5	INSULATOR-XSTR DAP-GL	28480	1200-0173	
	1205-0011	0	0	HEAT SINK TO-5/TO-39-CS	28480	1205-0011
A11A1Q9	1854-0720	3		TRANSISTOR NPN SI PD=500MW FT=4GHZ	28480	1854-0720
A11A1Q10	1854-0813	5		TRANSISTOR NPN 2N3501S SI TO-39 PD=1W	28480	1854-0813
	1200-0173	5		INSULATOR-XSTR DAP-GL	28480	1200-0173
	1205-0011	0	0	HEAT SINK TO-5/TO-39-CS	28480	1205-0011
A11A1R1	0757-0835	4	2	RESISTOR 6.81K 1% .5W F TC=0+-100	28480	0757-0835
A11A1R2	0757-0399	5		3	RESISTOR 82.5 1% .125W F TC=0+-100	24546
A11A1R3	0699-1346	0	7	RESISTOR 12.1 1% .125W F TC=0+-100	28480	0699-1346
A11A1R4	0757-0418	9		RESISTOR 619 1% .125W F TC=0+-100	24546	C4-1/8-T0-619R-F
A11A1R5	0698-4588	6		RESISTOR 383 1% .25W F TC=0+-100	24546	C5-1/4-T0-383R-F

See introduction to this section for ordering information.

\* Indicates factory selected value



Table 6-2. Replaceable Parts

Reference Designation	HP Part Number	C D	Qty	Description	Mfr Code	Mfr Part Number
A11A1R6	0698-7229	8		RESISTOR 511 1% .05W F TC=0+-100	24546	C3-1/8-T0-511R-F
A11A1R7	0698-4588	6		RESISTOR 383 1% .25W F TC=0+-100	24546	C5-1/4-T0-383R-F
A11A1R8	0699-1346	0		RESISTOR 12.1 1% .125W F TC=0+-100	26654	3C120J
A11A1R9	0698-7245	8		RESISTOR 2.37K 1% .05W F TC=0+-100	24546	C3-1/8-T0-2371-F
A11A1R10	0698-7217	4	2	RESISTOR 162 1% .05W F TC=0+-100	24546	C3-1/8-T0-162R-F
A11A1R11	0698-7231	2		RESISTOR 619 1% .05W F TC=0+-100	24546	C3-1/8-T0-619R-F
A11A1R12	0699-1346	0		RESISTOR 12.1 1% .125W F TC=0+-100	26654	3C120J
A11A1R13	0757-1090	5	7	RESISTOR 261 1% .5W F TC=0+-100	28480	0757-1090
A11A1R14	0698-7229	8		RESISTOR 511 1% .05W F TC=0+-100	24546	C3-1/8-T0-511R-F
A11A1R15	0698-7220	9		RESISTOR 215 1% .05W F TC=0+-100	24546	C3-1/8-T0-215R-F
A11A1R16	0698-7245	8		RESISTOR 2.37K 1% .05W F TC=0+-100	24546	C3-1/8-T0-2371-F
A11A1R17	0699-1346	0		RESISTOR 12.1 1% .125W F TC=0+-100	28480	0699-1346
A11A1R18	0698-4588	6		RESISTOR 383 1% .25W F TC=0+-100	24546	C5-1/4-T0-383R-F
A11A1R19	0698-7231	2		RESISTOR 619 1% .05W F TC=0+-100	24546	C3-1/8-T0-619R-F
A11A1R20	0699-1346	0		RESISTOR 12.1 1% .125W F TC=0+-100	28480	0699-1346
A11A1R21	0757-1090	5		RESISTOR 261 1% .5W F TC=0+-100	28480	0757-1090
A11A1R22	0699-1361	9		RESISTOR 51.1 1% .125W F TC=0+-100	28480	0699-1361
A11A1R23	0698-7205	0		RESISTOR 51.1 1% .05W F TC=0+-100	24546	C3-1/8-T0-51R1-F
A11A1R24	0698-7280	1		RESISTOR 68.1K 1% .05W F TC=0+-100	24546	C3-1/8-T0-6812-F
A11A1R25	0698-7238	9		RESISTOR 1.21K 1% .05W F TC=0+-100	24546	C3-1/8-T0-1211-F
A11A1R26	0698-7280	1		RESISTOR 68.1K 1% .05W F TC=0+-100	24546	C3-1/8-T0-6812-F
A11A1R27	0698-7238	9		RESISTOR 1.21K 1% .05W F TC=0+-100	24546	C3-1/8-T0-1211-F
A11A1R28	0698-7236	7		RESISTOR 1K 1% .05W F TC=0+-100	24546	C3-1/8-T0-1001-F
A11A1R29	0757-0280	3		RESISTOR 1K 1% .125W F TC=0+-100	24546	C4-1/8-T0-1001-F
A11A1R30	0698-3400	9	3	RESISTOR 147 1% .5W F TC=0+-100	28480	0698-3400
A11A1R31	0698-7188	8		RESISTOR 10 1% .05W F TC=0+-100	24546	C3-1/8-T0-10R-F
A11A1R32	0698-7260	7		RESISTOR 10K 1% .05W F TC=0+-100	24546	C3-1/8-T0-1002-F
A11A1R33	0757-0422	5	2	RESISTOR 909 1% .125W F TC=0+-100	24546	C4-1/8-T0-909R-F
A11A1R34	0757-0401	0	2	RESISTOR 100 1% .125W F TC=0+-100	24546	C4-1/8-T0-101-F
A11A1R35	0698-7205	0		RESISTOR 51.1 1% .05W F TC=0+-100	24546	C3-1/8-T0-51R1-F
A11A1R36	0698-7229	8		RESISTOR 511 1% .05W F TC=0+-100	24546	C3-1/8-T0-511R-F
A11A1R37	0698-7256	1		RESISTOR 6.81K 1% .05W F TC=0+-100	24546	C3-1/8-T0-6811-F
A11A1R38	0698-7243	6		RESISTOR 1.96K 1% .05W F TC=0+-100	24546	C3-1/8-T0-1961-F
A11A1R39	0698-7260	7		RESISTOR 10K 1% .05W F TC=0+-100	24546	C3-1/8-T0-1002-F
A11A1R40	0698-7248	1		RESISTOR 3.16K 1% .05W F TC=0+-100	24546	C3-1/8-T0-3161-F
A11A1R41	0698-3156	2		RESISTOR 14.7K 1% .125W F TC=0+-100	24546	C4-1/8-T0-1472-F
A11A1R42	2100-3090	0	2	RESISTOR-TRMR 500 10% C TOP-ADJ 17-TRN NOT ASSIGNED	32997	3292W-1-501
A11A1R43						
A11A1R44	0698-8825	2		RESISTOR 681K 1% .125W F TC=0+-100	28480	0698-8825
A11A1R45	0698-8825	2		RESISTOR 681K 1% .125W F TC=0+-100	28480	0698-8825
A11A1R46	0757-0280	3		RESISTOR 1K 1% .125W F TC=0+-100	24546	C4-1/8-T0-1001-F
A11A1R47	0698-6323	1	2	RESISTOR 100 .1% .125W F TC=0+-25	28480	0698-6323
A11A1R48	0698-7229	8		RESISTOR 511 1% .05W F TC=0+-100	24546	C3-1/8-T0-511R-F
A11A1R49	0698-6362	8		RESISTOR 1K .1% .125W F TC=0+-25	28480	0698-6362
A11A1R50	0757-0274	5		RESISTOR 1.21K 1% .125W F TC=0+-100	24546	C4-1/8-T0-1211-F
A11A1R51	0698-7284	5		RESISTOR 100K 1% .05W F TC=0+-100	24546	C3-1/8-T0-1003-F
A11A1R52	0698-6377	5	2	RESISTOR 200 .1% .125W F TC=0+-25	28480	0698-6377
A11A1R53	0698-6355	9	2	RESISTOR 400 .1% .125W F TC=0+-25	28480	0698-6355
A11A1R54	0698-8028	7	2	RESISTOR 800 1% .125W F TC=0+-100	19701	MF4C1/8-T0-800R-F
A11A1R55	0698-6103	5	2	RESISTOR 1.6K .1% .125W F TC=0+-50	28480	0698-6103
A11A1R56	0698-7570	2	1	RESISTOR 3.2K .5% .125W F TC=0+-50	19701	MF4C1/8-T2-3201-D
A11A1R57	0698-6624	5	2	RESISTOR 2K .1% .125W F TC=0+-25	28480	0698-6624
A11A1R58	0698-5323	9	2	RESISTOR 4K .5% .125W F TC=0+-50	28480	0698-5323
A11A1R59	0698-3200	7	2	RESISTOR 8K 1% .125W F TC=0+-100	24546	C4-1/8-T0-8001-F
A11A1R60	0698-7884	1	2	RESISTOR 16K 1% .125W F TC=0+-50	19701	MF4C1/8-T2-1602-F
A11A1R61	0698-6900	0	2	RESISTOR 32K .5% .125W F TC=0+-50	28480	0698-6900
A11A1R62	0757-0280	3		RESISTOR 1K 1% .125W F TC=0+-100	24546	C4-1/8-T0-1001-F
A11A1R63	0757-0280	3		RESISTOR 1K 1% .125W F TC=0+-100	24546	C4-1/8-T0-1001-F
A11A1R64	1810-0319	4	1	NETWORK-RES 16-DIP100.0K OHM X 8	01121	316B104
A11A1R65	0698-8827	4		RESISTOR 1M 1% .125W F TC=0+-100	28480	0698-8827
A11A1R66	0698-7260	7		RESISTOR 10K 1% .05W F TC=0+-100	24546	C3-1/8-T0-1002-F
A11A1R67	0698-7260	7		RESISTOR 10K 1% .05W F TC=0+-100	24546	C3-1/8-T0-1002-F
A11A1R68	0698-0084	9		RESISTOR 2.15K 1% .125W F TC=0+-100	24546	C4-1/8-T0-2151-F
A11A1R69	0698-3438	3		RESISTOR 147 1% .125W F TC=0+-100	24546	C4-1/8-T0-147R-F
A11A1R70	0698-7253	8		RESISTOR 5.11K 1% .05W F TC=0+-100	24546	C3-1/8-T0-5111-F

See introduction to this section for ordering information.

\* Indicates factory selected value

Table 6-2. Replaceable Parts

Reference Designation	HP Part Number	C D	Qty	Description	Mfr Code	Mfr Part Number
A11A1R71	0698-7253	8		RESISTOR 5.11K 1% .05W F TC=0+-100	24546	C3-1/8-T0-5111-F
A11A1R72	0698-7206	1		RESISTOR 56.2 1% .05W F TC=0+-100	24546	C3-1/8-T0-56R2-F
A11A1R73	0757-0280	3		RESISTOR 1K 1% .125W F TC=0+-100	24546	C4-1/8-T0-1001-F
A11A1R74	0698-7205	0		RESISTOR 51.1 1% .05W F TC=0+-100	24546	C3-1/8-T0-51R1-F
A11A1R75	0698-7284	5		RESISTOR 100K 1% .05W F TC=0+-100	24546	C3-1/8-T0-1003-F
A11A1R76	0698-7256	1		RESISTOR 6.81K 1% .05W F TC=0+-100	24546	C3-1/8-T0-6811-F
A11A1R77	0698-7256	1		RESISTOR 6.81K 1% .05W F TC=0+-100	24546	C3-1/8-T0-6811-F
A11A1R78	0698-7253	8		RESISTOR 5.11K 1% .05W F TC=0+-100	24546	C3-1/8-T0-5111-F
A11A1R79	0698-7256	1		RESISTOR 6.81K 1% .05W F TC=0+-100	24546	C3-1/8-T0-6811-F
A11A1R80	0698-7272	1		RESISTOR 31.6K 1% .05W F TC=0+-100	24546	C3-1/8-T0-3162-F
A11A1R81	0698-7272	1		RESISTOR 31.6K 1% .05W F TC=0+-100	24546	C3-1/8-T0-3162-F
A11A1R82	0698-8827	4		RESISTOR 1M 1% .125W F TC=0+-100	28480	0698-8827
A11A1R83	0698-7260	7		RESISTOR 10K 1% .05W F TC=0+-100	24546	C3-1/8-T0-1002-F
A11A1R84	0698-7260	7		RESISTOR 10K 1% .05W F TC=0+-100	24546	C3-1/8-T0-1002-F
A11A1R85	0699-1346	0		RESISTOR 12.1 1% .125W F TC=0+-100	28480	0699-1346
A11A1R86	0698-8381	5		RESISTOR 50 5% .1W C TC=0+-200	28480	0698-8381
A11A1R87	0698-7227	6	4	RESISTOR 422 1% .05W F TC=0+-100	24546	C3-1/8-T0-422R-F
A11A1R88	0698-7227	6		RESISTOR 422 1% .05W F TC=0+-100	24546	C3-1/8-T0-422R-F
A11A1R89	0698-7284	5		RESISTOR 100K 1% .05W F TC=0+-100	24546	C3-1/8-T0-1003-F
A11A1S1	3101-2566	6	3	SWITCH-RKR DIP-RKR-ASSY DPDT .5A 30VDC	28480	3101-2566
A11A1T1	9100-4365	1	6	TRANSFORMER-RF INPUT Z:50 OHMS;Z RATIO:1	28480	9100-4365
A11A1T2	9100-4365	1		TRANSFORMER-RF INPUT Z:50 OHMS;Z RATIO:1	28480	9100-4365
A11A1T3	9100-4365	1		TRANSFORMER-RF INPUT Z:50 OHMS;Z RATIO:1	28480	9100-4365
A11A1TP1	0360-0535	0		TERMINAL TEST POINT PCB	00000	ORDER BY DESCRIPTION
A11A1TP2	1252-0216	6	2	CONNECTOR-SGL CONT SKT .04-IN-BSC-SZ RND	28480	1252-0216
A11A1TP3	1250-0835	1		CONNECTOR-RF SMC M PC 50-OHM	28480	1250-0835
A11A1TP4	0360-0535	0		TERMINAL TEST POINT PCB	00000	ORDER BY DESCRIPTION
A11A1U1	1820-0668	7		IC BFR TTL NON-INV HEX 1-INP	01295	SN7407N
A11A1U2	1820-1858	9		IC FF TTL LS D-TYPE OCTL	01295	SN74LS377N
A11A1U3	1820-1433	6		IC SHF-RGTR TTL LS R-S SERIAL-IN PRL-OUT	01295	SN74LS164N
A11A1U4	1826-0605	4		IC MULTIPLEXR 8-CHAN-ANLG 16-DIP-C PKG	17856	DG508BK
A11A1U5	1820-1433	6		IC SHF-RGTR TTL LS R-S SERIAL-IN PRL-OUT	01295	SN74LS164N
A11A1U6	1820-1858	9		IC FF TTL LS D-TYPE OCTL	01295	SN74LS377N
A11A1U7	1820-0668	7		IC BFR TTL NON-INV HEX 1-INP	01295	SN7407N
A11A1U8	1826-0180	0	2	IC TIMER TTL MONO/ASTBL	01295	NE555P
A11A1U9	1826-0606	5		IC SWITCH ANLG QUAD 16-DIP-C PKG	17856	DG201BK
A11A1U10	1826-0783	9		IC OP AMP LOW-NOISE 8-DIP-C PKG	52063	XR5534ACN
2427A TO 2738A A11A1U11	1826-0759	9		IC COMPARATOR GP QUAD 14-DIP-C PKG	04713	LM339J
2814A AND ABOVE A11A1U11	1826-0138	8		IC COMPARATOR GP QUAD 14-DIP-C PKG	01295	LM339N
A11A1U12	1820-1437	0		IC MV TTL LS MONOSTBL DUAL	01295	SN74LS221N
A11A1U13	1820-1416	5		IC SCHMITT-TRIG TTL LS INTR	01295	SN74LS14N
A11A1U14	1820-1212	9		IC FF TTL LS J-K NEG-EDGE-TRIG	01295	SN74LS112AN
A11A1U15	1820-0535	7		IC DRVR TTL AND DUAL 2-INP	01295	SN75451BP
A11A1U16	1826-0785	1		IC OP AMP LOW-BIAS-H-IMPED DUAL 8-DIP-C	01295	TL072ACJG
A11A1U17	1820-1433	6		IC SHF-RGTR TTL LS R-S SERIAL-IN PRL-OUT	01295	SN74LS164N
A11A1U18	1820-1858	9		IC FF TTL LS D-TYPE OCTL	01295	SN74LS377N
A11A1U19	1826-0921	7		D/A 10-BIT 16-CBRZ/SDR CMOS	28480	1826-0921
A11A1U20	1826-0371	1		IC OP AMP LOW-BIAS-H-IMPED TO-99 PKG	27014	LF256H
A11A1VR1	1902-1428	3		DIODE-ZNR 4.6V DO-35 PD=.4W IR=1UA	28480	1902-1428
A11A1VR2	1902-1428	3		DIODE-ZNR 4.6V DO-35 PD=.4W IR=1UA	28480	1902-1428
A11A1VR3	1902-0680	7		DIODE-ZNR 1N827 6.2V 5% DO-35 .4W	24046	1N827
A11A1VR4	1902-1428	3		DIODE-ZNR 4.6V DO-35 PD=.4W IR=1UA	28480	1902-1428
A11A1Z1	0955-0219	8	2	MIXER-DOUBLE BALANCED RF: .5-500MHZ; IF	28480	0955-0219
	1251-3172	7	43	CONNECTOR-SGL CONT SKT .03-IN-BSC-SZ RND	28480	1251-3172

See introduction to this section for ordering information.

\* Indicates factory selected value

Table 6-2. Replaceable Parts

Reference Designation	HP Part Number	C D	Qty	Description	Mfr Code	Mfr Part Number
2427A TO 2611A A11A2	08642-60107	2	1	REFERENCE VCO ASSEMBLY	28480	08642-60107
2706A AND ABOVE A11A2	08642-60207	3	1	REFERENCE VCO ASSEMBLY	28480	08642-60207
A11A2C1	0121-0531	0	6	CAPACITOR-V TMR-CER .25-.7PF 250V	28480	0121-0531
A11A2C2	0160-5988	3	8	CAPACITOR-FXD 100PF +-5% 500VDC PORC	28480	0160-5988
A11A2C3	0160-5989	4	6	CAPACITOR-FXD 1PF +- .1PF 50VDC CER 0+-30	28480	0160-5989
A11A2C4	0160-5994	1	1	CAPACITOR-FXD 10PF +-5% 50VDC CER 0+-30	28480	0160-5994
A11A2C5	0160-5988	3		CAPACITOR-FXD 100PF +-5% 500VDC PORC	28480	0160-5988
A11A2C6	0160-5975	8		CAPACITOR-FXD 10PF +-5% 50VDC CER 0+-30	28480	0160-5975
A11A2C7	0160-5945	2		CAPACITOR-FXD .01UF +-10% 50VDC CER	28480	0160-5945
A11A2C8	0160-5975	8		CAPACITOR-FXD 10PF +-5% 50VDC CER 0+-30	28480	0160-5975
A11A2C9	0160-5995	2	1	CAPACITOR-FXD 4.7F +- .25PF 50VDC 0+-30	28480	0160-5995
A11A2C10	0160-5988	3		CAPACITOR-FXD 100PF +-5% 500VDC PORC	28480	0160-5988
A11A2C11	0160-5987	2	4	CAPACITOR-FXD 47PF +-5% 500VDC PORC	28480	0160-5987
A11A2C12	0160-5989	4		CAPACITOR-FXD 1PF +- .1PF 50VDC CER 0+-30	28480	0160-5989
A11A2C13	0160-3879	7		CAPACITOR-FXD .01UF +-20% 100VDC CER	28480	0160-3879
A11A2C14	0160-3879	7		CAPACITOR-FXD .01UF +-20% 100VDC CER	28480	0160-3879
A11A2C15	0121-0531	0		CAPACITOR-V TMR-CER .25-.7PF 250V	28480	0121-0531
A11A2C16	0160-3468	0	2	CAPACITOR-FXD .12UF +-10% 80VDC POLYE	28480	0160-3468
A11A2C17	0160-3879	7		CAPACITOR-FXD .01UF +-20% 100VDC CER	28480	0160-3879
A11A2C18	0160-3879	7		CAPACITOR-FXD .01UF +-20% 100VDC CER	28480	0160-3879
2427A TO 2706A A11A2C19-C22 2731A ONLY				NOT ASSIGNED		
A11A2C19	0160-5988	3	7	CAPACITOR-FXD 100PF +-5% 500VDC PORC	28480	0160-5988
A11A2C20	0160-5988	3	7	CAPACITOR-FXD 100PF +-5% 500VDC PORC	28480	0160-5988
A11A2C21	0160-5988	3	7	CAPACITOR-FXD 100PF +-5% 500VDC PORC	28480	0160-5988
A11A2C22	0160-5988	3	7	CAPACITOR-FXD 100PF +-5% 500VDC PORC	28480	0160-5988
2738A AND ABOVE A11A2C19-C22				NOT ASSIGNED		
A11A2CR1	0122-0157	8	2	DIODE-VVC 15PF 5% BVR=60V	28480	0122-0157
A11A2CR2	1901-0639	4	56	DIODE-PIN	28480	5082-3080
A11A2CR3	1901-0639	4		DIODE-PIN	28480	5082-3080
A11A2CR4	0122-0155	6	3	DIODE-VVC 6.8PF 5% BVR=60V	28480	0122-0155
2427A TO 2611A A11A2CR5 2706A AND ABOVE A11A2CR5				NOT ASSIGNED		
A11A2CR5	1901-0880	7		DIODE-GEN PRP 125MA D0-35	28480	1901-0880
A11A2E1	08642-60149	2		CORE ASSEMBLY	28480	08642-60149
A11A2E2	08642-60149	2		CORE ASSEMBLY	28480	08642-60149
A11A2E3	08642-60149	2		CORE ASSEMBLY	28480	08642-60149
A11A2E4	08642-60149	2		CORE ASSEMBLY	28480	08642-60149
A11A2E5	08642-60149	2		CORE ASSEMBLY	28480	08642-60149
A11A2J1	1250-2090	4		CONNECTOR-RF SMC M SGL-HOLE-RR 50-OHM	28480	1250-2090
A11A2J2	08642-20081	7		ELSTMR CONS7D SMC	28480	08642-20081
A11A2J3	1251-8758	5		CONN-POST TYPE .100-PIN-SPCG 8-CONT	28480	1251-8758
A11A2J4	08656-00033	3	4	CLIP SEMI-R GRND	28480	08656-00033
A11A2J5	1251-2194	1	15	CONNECTOR-SGL CONT SKT .021-IN-BSC-SZ	28480	1251-2194
A11A2L1	9100-2247	4		INDUCTOR RF-CH-MLD 100NH 10% .105DX.26LG	28480	9100-2247
A11A2L2	9100-2247	4		INDUCTOR RF-CH-MLD 100NH 10% .105DX.26LG	28480	9100-2247
A11A2L3	9140-1087	2		INDUCTOR-FIXED 120-1300 HZ	28480	9140-1087
A11A2L4	9140-1087	2		INDUCTOR-FIXED 120-1300 HZ	28480	9140-1087
A11A2L5	9100-2247	4		INDUCTOR RF-CH-MLD 100NH 10% .105DX.26LG	28480	9100-2247
A11A2L6	9100-2247	4		INDUCTOR RF-CH-MLD 100NH 10% .105DX.26LG	28480	9100-2247
A11A2L7	9140-1087	2		INDUCTOR-FIXED 120-1300 HZ	28480	9140-1087
A11A2Q1	1854-0946	5	31	TRANSISTOR NPN SI PD=290MW	28480	1854-0946
A11A2Q2	1854-1009	3	5	TRANSISTOR NPN SI PD=580MW	28480	1854-1009
A11A2Q3	1854-0946	5		TRANSISTOR NPN SI PD=290MW	28480	1854-0946
A11A2Q4	1854-0597	2	2	TRANSISTOR NPN 2N5943 SI TO-39 PD=1W	04713	2N5943
A11A2Q5	1853-0459	3		TRANSISTOR PNP SI PD=625MW FT=200MHZ	28480	1853-0459
A11A2Q6	1853-0459	3		TRANSISTOR PNP SI PD=625MW FT=200MHZ	28480	1853-0459
A11A2R1	0699-1372	2		RESISTOR 1.47K 1% .125W F TC=0+-100	28480	0699-1372
A11A2R2	0698-3441	8		RESISTOR 215 1% .125W F TC=0+-100	24546	C4-1/8-T0-215R-F
A11A2R3	0699-1430	3		RESISTOR 422 1% .125W F TC=0+-100	28480	0699-1430
A11A2R4	0699-1346	0		RESISTOR 12.1 1% .125W F TC=0+-100	28480	0699-1346
A11A2R5	0698-7250	5		RESISTOR 3.83K 1% .05W F TC=0+-100	24546	C3-1/8-T0-3831-F

See introduction to this section for ordering information.

\* Indicates factory selected value

Table 6-2. Replaceable Parts

Reference Designation	HP Part Number	C D	Qty	Description	Mfr Code	Mfr Part Number
A11A2TP1	0360-0535	0		TERMINAL TEST POINT PCB	00000	ORDER BY DESCRIPTION
A11A2TP2	0360-0535	0		TERMINAL TEST POINT PCB	00000	ORDER BY DESCRIPTION
A11A2TP3	0360-0535	0		TERMINAL TEST POINT PCB	00000	ORDER BY DESCRIPTION
A11A2TP4				PART IS ETCHED ON CIRCUIT BOARD		
A11A2TP5				PART IS ETCHED ON CIRCUIT BOARD		
A11A2TP6	0360-0535	0		TERMINAL TEST POINT PCB	00000	ORDER BY DESCRIPTION
A11A2TP7	0360-0535	0		TERMINAL TEST POINT PCB	00000	ORDER BY DESCRIPTION
A11A2VR1	1902-1428	3		DIODE-ZNR 4.6V DO-35 PD=.4W IR=1UA	28480	1902-1428
A11A2VR2	1902-1428	3		DIODE-ZNR 4.6V DO-35 PD=.4W IR=1UA	28480	1902-1428
A11A1W1-W100				NOT ASSIGNED		
A11A1W101				PART IS ETCHED TRACE ON CIRCUIT BOARD		
A11A1W102				PART IS ETCHED TRACE ON CIRCUIT BOARD		
A11A1W103				PART IS ETCHED TRACE ON CIRCUIT BOARD		
A11A1W104				PART IS ETCHED TRACE ON CIRCUIT BOARD		
A11A1W105				PART IS ETCHED TRACE ON CIRCUIT BOARD		

See introduction to this section for ordering information.

\* Indicates factory selected value

Table 6-2. Replaceable Parts

Reference Designation	HP Part Number	C D	Qty	Description	Mfr Code	Mfr Part Number
<b>A11A3</b>	08642-60108	3	1	REFERENCE MIXER/SPLITTER ASSEMBLY	28480	08642-60108
A11A3C1	0160-3879	7		CAPACITOR-FXD .01UF +-20% 100VDC CER	28480	0160-3879
A11A3C2	0160-3879	7		CAPACITOR-FXD .01UF +-20% 100VDC CER	28480	0160-3879
A11A3C3	0160-3879	7		CAPACITOR-FXD .01UF +-20% 100VDC CER	28480	0160-3879
A11A3C4	0160-3879	7		CAPACITOR-FXD .01UF +-20% 100VDC CER	28480	0160-3879
A11A3C5	0160-3874	2		CAPACITOR-FXD 10PF +- .5PF 200VDC CER	28480	0160-3874
A11A3C6	0160-3873	1		CAPACITOR-FXD 4.7PF +- .5PF 200VDC CER	28480	0160-3873
A11A3C7	0160-3872	0		CAPACITOR-FXD 2.2PF +- .25PF 200VDC CER	28480	0160-3872
A11A3C8	0160-3872	0		CAPACITOR-FXD 2.2PF +- .25PF 200VDC CER	28480	0160-3872
A11A3C9	0160-3872	0		CAPACITOR-FXD 2.2PF +- .25PF 200VDC CER	28480	0160-3872
A11A3C10	0160-3872	0		CAPACITOR-FXD 2.2PF +- .25PF 200VDC CER	28480	0160-3872
A11A3C11	0160-3879	7		CAPACITOR-FXD .01UF +-20% 100VDC CER	28480	0160-3879
A11A3C12	0160-3879	7		CAPACITOR-FXD .01UF +-20% 100VDC CER	28480	0160-3879
A11A3C13	0160-5947	4		CAPACITOR-FXD 1000PF +-10% 50VDC CER	28480	0160-5947
A11A3C14	0160-3879	7		CAPACITOR-FXD .01UF +-20% 100VDC CER	28480	0160-3879
A11A3C15	0160-5975	8		CAPACITOR-FXD 10PF +-5% 50VDC CER 0+-30	28480	0160-5975
A11A3C16	0160-4498	8		CAPACITOR-FXD 5.6PF +- .5PF 200VDC CER	28480	0160-4498
A11A3C17	0160-3879	7		CAPACITOR-FXD .01UF +-20% 100VDC CER	28480	0160-3879
A11A3C18	0160-5945	2		CAPACITOR-FXD .01UF +-10% 50VDC CER	28480	0160-5945
A11A3C19	0160-4389	6		CAPACITOR-FXD 100PF +-5PF 200VDC CER	28480	0160-4389
A11A3C20	0160-5947	4		CAPACITOR-FXD 1000PF +-10% 50VDC CER	28480	0160-5947
A11A3C21	0160-4801	7		CAPACITOR-FXD 100PF +-5% 100VDC CER	28480	0160-4801
A11A3C22	0160-4766	3		CAPACITOR-FXD 30PF +-5% 200VDC CER 0+-30	28480	0160-4766
A11A3C23	0160-4801	7		CAPACITOR-FXD 100PF +-5% 100VDC CER	28480	0160-4801
A11A3C24	0160-5961	2		CAPACITOR-FXD 22PF +-5% 50VDC CER 0+-30	28480	0160-5961
A11A3C25	0160-4801	7		CAPACITOR-FXD 100PF +-5% 100VDC CER	28480	0160-4801
A11A3C26	0160-4766	3		CAPACITOR-FXD 30PF +-5% 200VDC CER 0+-30	28480	0160-4766
A11A3C27	0160-5973	6		CAPACITOR-FXD 6.8PF +- .5PF 50VDC CER	28480	0160-5973
A11A3C28	0160-4493	3	4	CAPACITOR-FXD 27PF +-5% 200VDC CER 0+-30	28480	0160-4493
A11A3C29	0160-4493	3		CAPACITOR-FXD 27PF +-5% 200VDC CER 0+-30	28480	0160-4493
A11A3C30	0160-4801	7		CAPACITOR-FXD 100PF +-5% 100VDC CER	28480	0160-4801
A11A3C31	0160-4801	7		CAPACITOR-FXD 100PF +-5% 100VDC CER	28480	0160-4801
A11A3C32	0160-6222	0		CAPACITOR-FXD .1UF +-10% 50VDC CER	28480	0160-6222
A11A3C33	0160-4535	4		CAPACITOR-FXD 1UF +-10% 50VDC CER	28480	0160-4535
A11A3C34	0160-6222	0		CAPACITOR-FXD .1UF +-10% 50VDC CER	28480	0160-6222
A11A3C35	0160-6222	0		CAPACITOR-FXD .1UF +-10% 50VDC CER	28480	0160-6222
A11A3C36	0160-6222	0		CAPACITOR-FXD .1UF +-10% 50VDC CER	28480	0160-6222
A11A3C37	0160-6222	0		CAPACITOR-FXD .1UF +-10% 50VDC CER	28480	0160-6222
A11A3C38	0160-6222	0		CAPACITOR-FXD .1UF +-10% 50VDC CER	28480	0160-6222
A11A3C39	0160-6222	0		CAPACITOR-FXD .1UF +-10% 50VDC CER	28480	0160-6222
A11A3C40	0160-6222	0		CAPACITOR-FXD .1UF +-10% 50VDC CER	28480	0160-6222
A11A3FL1	08642-60132	3	1	BD 1GHZ 15PL LPF	28480	08642-60132
A11A3FL2	08642-60131	2	1	BD 860 MHZ LPF	28480	08642-60131
A11A3J1	1252-0318	9		CONN POST SKT 2	28480	1251-0318
A11A3J2	1250-1425	7		CONNECTOR-RF SMC M SGL-HOLE-RR 50-OHM	28480	1250-1425
A11A3J3	08642-20080	6	2	ELSTMR CON SMC R	28480	08642-20080
A11A3J3	1250-1425	7		CONNECTOR-RF SMC M SGL-HOLE-RR 50-OHM	28480	1250-1425
A11A3J3	08642-20081	7		ELSTMR COND SMC	28480	08642-20081
A11A3J4	1250-1425	7		CONNECTOR-RF SMC M SGL-HOLE-RR 50-OHM	28480	1250-1425
A11A3J5	08642-20080	6		ELSTMR CON SMC R	28480	08642-20080
A11A3J6	1252-0318	9		CONN POST SKT 2	28480	1252-0318
A11A3J6	1251-2194	1		CONNECTOR-SGL CONT SKT .021-IN-BSC-SZ	28480	1251-2194
A11A3L1	9140-0158	6	16	INDUCTOR RF-CH-MLD 1UH 10% .105DX.26LG	28480	9140-0158
A11A3L2	9140-0158	6		INDUCTOR RF-CH-MLD 1UH 10% .105DX.26LG	28480	9140-0158
A11A3L3	9140-0158	6		INDUCTOR RF-CH-MLD 1UH 10% .105DX.26LG	28480	9140-0158
A11A3L4	9140-0158	6		INDUCTOR RF-CH-MLD 1UH 10% .105DX.26LG	28480	9140-0158
A11A3L5	9135-0070	0	4	INDUCTOR RF-CH-MLD 24NH 7% .102DX.26LG	28480	9135-0070
A11A3L6	9135-0070	0		INDUCTOR RF-CH-MLD 24NH 7% .102DX.26LG	28480	9135-0070
A11A3L7	9140-0158	6		INDUCTOR RF-CH-MLD 1UH 10% .105DX.26LG	28480	9140-0158
2427A TO 2534A A11A3L8	9135-0070	0		INDUCTOR RF-CH-MLD 24NH 7% .102DX.26LG	28480	9135-0070
2535A AND ABOVE A11A3L8	9135-0077	7		INDUCTOR RF-CH-MLD 36NH 6% .102DX.26LG	28480	9135-0077
A11A3L9	9135-0072	2	6	INDUCTOR RF-CH-MLD 56NH 5% .102DX.26LG	28480	9135-0072
A11A3L10	9135-0079	9		INDUCTOR RF-CH-MLD 100NH 5% .102DX.26LG	28480	9135-0079

See introduction to this section for ordering information.

\* Indicates factory selected value

Table 6-2. Replaceable Parts

Reference Designation	HP Part Number	C D	Qty	Description	Mfr Code	Mfr Part Number
A11A3L11 A11A3L12 A11A3L13 A11A3L14 A11A3L15	9135-0072	2		INDUCTOR RF-CH-MLD 56NH 5% .102DX.26LG PART IS ETCHED TRACE ON CIRCUIT BOARD PART IS ETCHED TRACE ON CIRCUIT BOARD PART IS ETCHED TRACE ON CIRCUIT BOARD PART IS ETCHED TRACE ON CIRCUIT BOARD	28480	9135-0072
A11A3L16 A11A3L17 A11A3L18				PART IS ETCHED TRACE ON CIRCUIT BOARD PART IS ETCHED TRACE ON CIRCUIT BOARD PART IS ETCHED TRACE ON CIRCUIT BOARD		
A11A3MP1 A11A3MP2	0362-0804 08656-00033	0 3	51	TERMINAL-STUD SGL-PIN SWGFRM-MTG CLIP SEMI-R GRND	28480 28480	0362-0804 08656-00033
A11A3Q1 A11A3Q2 A11A3Q3 A11A3Q4 A11A3Q5	1854-0946 1854-0946 1854-0946 1854-0946 1854-0946	5 5 5 5 5		TRANSISTOR NPN SI PD=290Mw TRANSISTOR NPN SI PD=290Mw TRANSISTOR NPN SI PD=290Mw TRANSISTOR NPN SI PD=290Mw TRANSISTOR NPN SI PD=290Mw	28480 28480 28480 28480 28480	1854-0946 1854-0946 1854-0946 1854-0946 1854-0946
A11A3Q6 A11A3Q7 A11A3Q8 A11A3Q9	1854-0946 1854-0946 1854-0946 1854-1009	5 5 5 3		TRANSISTOR NPN SI PD=290Mw TRANSISTOR NPN SI PD=290Mw TRANSISTOR NPN SI PD=290Mw TRANSISTOR NPN SI PD=580Mw	28480 28480 28480 28480	1854-0946 1854-0946 1854-0946 1854-1009
A11A3R1 A11A3R2 A11A3R3 A11A3R4 A11A3R5	0698-7205 0699-1423 0757-0419 0698-7205 0698-7205	0 4 0 0 0		RESISTOR 51.1 1% .05W F TC=0+-100 RESISTOR 215 1% .125W F TC=0+-100 RESISTOR 681 1% .125W F TC=0+-100 RESISTOR 51.1 1% .05W F TC=0+-100 RESISTOR 51.1 1% .05W F TC=0+-100	24546 28480 24546 24546 24546	C3-1/8-T0-51R1-F 0699-1423 C4-1/8-T0-681R-F C3-1/8-T0-51R1-F C3-1/8-T0-51R1-F
A11A3R6 A11A3R7 A11A3R8 A11A3R9 A11A3R10	0699-1423 0757-0419 0698-1361 0699-1423 0757-0417	4 0 9 4 8	6	RESISTOR 215 1% .125W F TC=0+-100 RESISTOR 681 1% .125W F TC=0+-100 RESISTOR 51.1 1% .125W F TC=0+-100 RESISTOR 215 1% .125W F TC=0+-100 RESISTOR 562 1% .125W F TC=0+-100	28480 24546 28480 28480 24546	0699-1423 C4-1/8-T0-681R-F 0699-1361 0699-1423 C4-1/8-T0-562R-F
A11A3R11 A11A3R12 A11A3R13 A11A3R14 A11A3R15	0698-1361 0699-1423 0698-0082 0698-7205 0699-1423	9 4 7 0 4	4	RESISTOR 51.1 1% .125W F TC=0+-100 RESISTOR 215 1% .125W F TC=0+-100 RESISTOR 464 1% .125W F TC=0+-100 RESISTOR 51.1 1% .05W F TC=0+-100 RESISTOR 215 1% .125W F TC=0+-100	28480 28480 24546 24546 28480	0699-1361 0699-1423 C4-1/8-T0-4640-F C3-1/8-T0-51R1-F 0699-1423
A11A3R16 A11A3R17 A11A3R18 A11A3R19 A11A3R20	0698-3438 0699-1346 0699-1346 0698-7205 0698-7205	3 0 0 0 0		RESISTOR 147 1% .125W F TC=0+-100 RESISTOR 12.1 1% .125W F TC=0+-100 RESISTOR 12.1 1% .125W F TC=0+-100 RESISTOR 51.1 1% .05W F TC=0+-100 RESISTOR 51.1 1% .05W F TC=0+-100	24546 28480 28480 24546 24546	C4-1/8-T0-147R-F 0699-1346 0699-1346 C3-1/8-T0-51R1-F C3-1/8-T0-51R1-F
A11A3R21 A11A3R22 A11A3R23 A11A3R24 A11A3R25	0698-7205 0757-0417 0698-7205 0699-1423 0698-0082	0 8 0 4 7		RESISTOR 51.1 1% .05W F TC=0+-100 RESISTOR 562 1% .125W F TC=0+-100 RESISTOR 51.1 1% .05W F TC=0+-100 RESISTOR 215 1% .125W F TC=0+-100 RESISTOR 464 1% .125W F TC=0+-100	24546 24546 24546 28480 24546	C3-1/8-T0-51R1-F C4-1/8-T0-562R-F C3-1/8-T0-51R1-F 0699-1423 C4-1/8-T0-4640-F
A11A3R26 A11A3R27 A11A3R28 A11A3R29 A11A3R30	0698-4579 0698-7205 0699-1423 0699-1432 0698-3102	5 0 4 5 8	1   6	RESISTOR 261 1% .25W F TC=0+-100 RESISTOR 51.1 1% .05W F TC=0+-100 RESISTOR 215 1% .125W F TC=0+-100 RESISTOR 511 1% .125W F TC=0+-100 RESISTOR 237 1% .5W F TC=0+-100	24546 24546 28480 28480 28480	C5-1/4-T0-261R-F C3-1/8-T0-51R1-F 0699-1423 0699-1432 0698-3102
A11A3R31 A11A3R32 A11A3R33 A11A3R34 A11A3R35	0698-3102 0699-1423 0698-1361 0699-1826 0699-1827	8 4 9 1 2	1   2	RESISTOR 237 1% .5W F TC=0+-100 RESISTOR 215 1% .125W F TC=0+-100 RESISTOR 51.1 1% .125W F TC=0+-100 RESISTOR 45.3 1% .2W C TC=0+-200 RESISTOR 130 1% .2W C TC=0+-200	28480 28480 28480 28480 28480	0698-3102 0699-1423 0699-1361 0699-1826 0699-1827
A11A3R36 A11A3R37 A11A3R38 A11A3R39 A11A3R40	0699-1827 0699-1423 0698-7205 0698-7205 0698-7205	2 4 0 0 0		RESISTOR 130 1% .2W C TC=0+-200 RESISTOR 215 1% .125W F TC=0+-100 RESISTOR 51.1 1% .05W F TC=0+-100 RESISTOR 51.1 1% .05W F TC=0+-100 RESISTOR 51.1 1% .05W F TC=0+-100	28480 28480 24546 24546 24546	0699-1827 0699-1423 C3-1/8-T0-51R1-F C3-1/8-T0-51R1-F C3-1/8-T0-51R1-F
A11A3R41 A11A3R42 A11A3R43 A11A3R44 A11A3R45	0698-1361 0699-1372 0699-1372 0699-1372 0699-1372	9 2 2 2 2		RESISTOR 51.1 1% .125W F TC=0+-100 RESISTOR 1.47K 1% .125W F TC=0+-100 RESISTOR 1.47K 1% .125W F TC=0+-100 RESISTOR 1.47K 1% .125W F TC=0+-100 RESISTOR 1.47K 1% .125W F TC=0+-100	28480 28480 28480 28480 28480	0699-1361 0699-1372 0699-1372 0699-1372 0699-1372

See introduction to this section for ordering information.

\* Indicates factory selected value

Table 6-2. Replaceable Parts

Reference Designation	HP Part Number	C D	Qty	Description	Mfr Code	Mfr Part Number
A11A3R46	0699-1372	2		RESISTOR 1.47K 1% .125W F TC=0+-100	28480	0699-1372
A11A3R47	0699-1372	2		RESISTOR 1.47K 1% .125W F TC=0+-100	28480	0699-1372
A11A3R48	0699-1372	2		RESISTOR 1.47K 1% .125W F TC=0+-100	28480	0699-1372
A11A3R49	0699-1432	4		RESISTOR 511 1% .125W F TC=0+-100	28480	0699-1432
A11A3R50	0699-1423	4		RESISTOR 215 1% .125W F TC=0+-100	28480	0699-1423
A11A3VR1	1902-1428	3		DIODE-ZNR 4.6V DO-35 PD=.4W IR=1UA	28480	1902-1428
A11A3VR2	1902-1428	3		DIODE-ZNR 4.6V DO-35 PD=.4W IR=1UA	28480	1902-1428
A11A3VR3	1902-1428	3		DIODE-ZNR 4.6V DO-35 PD=.4W IR=1UA	28480	1902-1428
A11A3VR4	1902-1428	3		DIODE-ZNR 4.6V DO-35 PD=.4W IR=1UA	28480	1902-1428
A11A3VR5	1902-1428	3		DIODE ZNR 4.6V DO-35 PD=.4W IR=1UA	28480	1902-1428
A11A3VR6	1902-1428	3		DIODE-ZNR 4.6V DO-35 PD=.4W IR=1UA	28480	1902-1428
A11A3VR7	1902-1428	3		DIODE-ZNR 4.6V DO-35 PD=.4W IR=1UA	28480	1902-1428
A11A3VR8	1902-1428	3		DIODE-ZNR 4.6V DO-35 PD=.4W IR=1UA	28480	1902-1428
A11A3VR9	1902-0950	4	1	DIODE-ZNR 4.7V 5% DO-35 PD=.4W TC=+.025X	28480	1902-0950
A11A3Z1	0960-0682	0	2	POWER SPLITTER-RF PC MOUNT: 10-1500MHZ	28480	0960-0682
	1251-3172	7		CONNECTOR-SGL CONT SKT .03-IN-BSC-SZ RND	28480	1251-3172
A11A3Z2		4	1	MXR DBL .05-2GHZ	28480	
	1251-3172	7		CONNECTOR-SGL CONT SKT .03-IN-BSC-SZ RND	28480	1251-3172

See introduction to this section for ordering information

\* Indicates factory selected value





Table 6-2. Replaceable Parts

Reference Designation	HP Part Number	C D	Qty	Description	Mfr Code	Mfr Part Number
<b>A12</b>						
A12	08642-60897	7	1	SUM LOOP/DIVIDER MODULE	28480	08642-60897
A12	08642-69897	5	1	SUM LOOP/DIVIDER MODULE (RESTORED)	28480	08642-69897
A12FL1	08642-80013	1		FLTR LP 3M BKT	28480	08642-80013
A12FL2	9135-0233	7		FLTR LP .3G 100V	28480	9135-0233
A12MP1	08642-20012	4	1	COVER SUM VCO/MIXER/SPLITTER	28480	08642-20012
A12MP2	08642-40055	7		GASKET FEEDTHRU5	28480	08642-40055
A12MP3	08642-40058	0	6	GASKET FEEDTHRU	28480	08642-40058
A12MP4	08642-00006	4	2	CVR MXR ACCES RT	28480	08642-00006
A12MP5	08642-00044	0		CVR MXR ACCES	28480	08642-00044
A12MP6	0515-1101	7		SCREW-MACH M4 X 0.7 8MM-LG 90-DEG-FLH-HD (ATTACH ACCESS COVERS TO COVER)	28480	0515-1101
A12MP7	08642-20013	5	1	BASE SUM LOOP	28480	08642-20013
A12MP8	3050-0990	7		WASHER-FL NM NO. 000 .04-IN-ID .25-IN-OD	28480	3050-0990
A12MP9	0515-1521	5		SCREW-MACH M3 X 0.5 5MM-LG 90-DEG-FLH-HD (ATTACH FILTER TO BASE)	28480	0515-1521
A12MP10	08642-00002	0		GASKET 10 P FLTR	28480	08642-00002
A12MP11	08642-20014	6	1	COVER SUM PHASE DETECTOR/DIVIDER	28480	08642-20014
A12MP12	0515-0684	9		SCREW-MACH M4 X 0.7 6MM-LG PAN-HD (ATTACH BOARDS TO BASE)	28480	0515-0684
A12MP13	0515-0381	3		SCREW-MACH M4 X 0.7 10MM-LG PAN-HD (ATTACH COVERS TO BASE)	00000	ORDER BY DESCRIPTION
A12MP14	8160-0472	8		RFI ROUND STRIP BE-CU SN-PL .093-IN-OD (SPIRA SHIELD)	28480	8160-0472
A12MP15	08642-00050	8		SLIDE-MODUL 57R4 (FRONT)	28480	08642-00050
A12MP16	08642-00049	5		SLIDE-MDL469R56 (REAR)	28480	08642-00049
A12MP17	0515-1102	8		SCREW-MACH M3 X 0.5 8MM-LG 90-DEG-FLH-HD (ATTACH MODULE SLIDES TO BASE)	28480	0515-1102
A12MP18	08642-80068	6	1	LABEL-SUM 60005	28480	08642-80068
A12W1	08642-20066	8		CABLE SR JUMPER (A12A2J4 TO A12A1J3)	28480	08642-20066
A12W2	08642-60045	7	1	CBL-COAX 907 (A12A3J2 TO A12A2J3)	28480	08642-60045
A12W3	08642-60047	9	1	CBL-COAX 902 (A12A2J1 TO A12A3J5)	28480	08642-60047
A12W4	5061-4810	3	1	CBL-COAX 91 (A12A1J1 TO A12A3J4)	28480	5061-4810

See introduction to this section for ordering information.

\* Indicates factory selected value



Table 6-2. Replaceable Parts

Reference Designation	HP Part Number	C D	Qty	Description	Mfr Code	Mfr Part Number
<i>2427A TO 2613A</i> <b>A12A1</b>	08642-60109	4	1	SUM VCO ASSEMBLY	28480	08642-60109
<i>2708A AND ABOVE</i> <b>A12A1</b>	08642-60209	5	1	SUM VCO ASSEMBLY	28480	08642-60209
A12A1C1	0160-3468	0		CAPACITOR-FXD .12UF +-10% 80VDC POLYE	28480	0160-3468
A12A1C2	0121-0531	0		CAPACITOR-V TRMR-CER .25-.7PF 250V	28480	0121-0531
A12A1C3	0121-0531	0		CAPACITOR-V TRMR-CER .25-.7PF 250V	28480	0121-0531
A12A1C4	0160-0576	5		CAPACITOR-FXD .1UF +-20% 50VDC CER	28480	0160-0576
A12A1C5	0160-5988	3		CAPACITOR-FXD 100PF +-5% 500VDC PORC	28480	0160-5988
A12A1C6	0160-5989	4		CAPACITOR-FXD 1PF +- .1PF 50VDC CER 0+-30	28480	0160-5989
A12A1C7	0160-5989	4		CAPACITOR-FXD 1PF +- .1PF 50VDC CER 0+-30	28480	0160-5989
A12A1C8	0160-5988	3		CAPACITOR-FXD 100PF +-5% 500VDC PORC	28480	0160-5988
A12A1C9	0160-5990	7	1	CAPACITOR-FXD 12PF +-5% 50VDC CER 0+-30	28480	0160-5990
A12A1C10	0160-5988	3		CAPACITOR-FXD 100PF +-5% 500VDC PORC	28480	0160-5988
A12A1C11	0160-5987	2		CAPACITOR-FXD 47PF +-5% 500VDC PORC	28480	0160-5987
A12A1C12	0160-5991	8	1	CAPACITOR-FXD 8.2PF +-5% 50VDC CER 0+-30	28480	0160-5991
A12A1C13	0160-5975	8		CAPACITOR-FXD 10PF +-5% 50VDC CER 0+-30	28480	0160-5975
A12A1C14	0160-5945	2		CAPACITOR-FXD .01UF +-10% 50VDC CER	28480	0160-5945
A12A1C15	0160-5975	8		CAPACITOR-FXD 10PF +-5% 50VDC CER 0+-30	28480	0160-5975
A12A1C16	0160-5993	0	1	CAPACITOR-FXD 3.3PF +- .25PF 50VDC CER	28480	0160-5993
A12A1C17	0160-5987	2		CAPACITOR-FXD 47PF +-5% 500VDC PORC	28480	0160-5987
A12A1C18	0160-5988	3		CAPACITOR-FXD 100PF +-5% 500VDC PORC	28480	0160-5988
A12A1C19	0160-5989	4		CAPACITOR-FXD 1PF +- .1PF 50VDC CER 0+-30	28480	0160-5989
A12A1C20	0160-5987	2		CAPACITOR-FXD 47PF +-5% 500VDC PORC	28480	0160-5987
A12A1C21	0160-5992	9	1	CAPACITOR-FXD 5.1PF +- .25PF 50VDC CER	28480	0160-5992
A12A1C22	0160-3879	7		CAPACITOR-FXD .01UF +-20% 100VDC CER	28480	0160-3879
A12A1C23	0160-5989	4		CAPACITOR-FXD 1PF +- .1PF 50VDC CER 0+-30	28480	0160-5989
A12A1C24	0160-5988	3		CAPACITOR-FXD 100PF +-5% 500VDC PORC	28480	0160-5988
A12A1C25	0160-3879	7		CAPACITOR-FXD .01UF +-20% 100VDC CER	28480	0160-3879
A12A1C26	0121-0531	0		CAPACITOR-V TRMR-CER .25-.7PF 250V	28480	0121-0531
A12A1C27	0121-0531	0		CAPACITOR-V TRMR-CER .25-.7PF 250V	28480	0121-0531
A12A1C28	0160-3879	7		CAPACITOR-FXD .01UF +-20% 100VDC CER	28480	0160-3879
<i>2427A TO 2706A</i> <i>A12A1C29-C36</i> <i>2731A ONLY</i>				NOT ASSIGNED		
A12A1C29	0160-5988	3	7	CAPACITOR-FXD 100PF +-55 500VDC PORC	28480	0160-5988
A12A1C30	0160-5988	3	7	CAPACITOR-FXD 100PF +-55 500VDC PORC	28480	0160-5988
A12A1C31	0160-5988	3	7	CAPACITOR-FXD 100PF +-55 500VDC PORC	28480	0160-5988
A12A1C32	0160-5988	3	7	CAPACITOR-FXD 100PF +-55 500VDC PORC	28480	0160-5988
A12A1C33	0160-5988	3	7	CAPACITOR-FXD 100PF +-55 500VDC PORC	28480	0160-5988
A12A1C34	0160-5988	3	7	CAPACITOR-FXD 100PF +-55 500VDC PORC	28480	0160-5988
A12A1C35	0160-5988	3	7	CAPACITOR-FXD 100PF +-55 500VDC PORC	28480	0160-5988
A12A1C36	0160-5988	3	7	CAPACITOR-FXD 100PF +-55 500VDC PORC	28480	0160-5988
<i>2738A AND ABOVE</i> <i>A12A1C29-C36</i>				NOT ASSIGNED		
A12A1CR1	0122-0157	8	1	DIODE-VVC 15PF 5% BVR=60V	28480	0122-0157
A12A1CR2	0122-0156	7		DIODE-VVC 10PF 5% BVR=60V	28480	0122-0156
A12A1CR3	0122-0155	6		DIODE-VVC 6.8PF 5% BVR=60V	28480	0122-0155
A12A1CR4	0122-0170	5		DIODE-VVC 6.8PF 5% BVR=60V	28480	0122-0170
A12A1CR5	1901-0639	4		DIODE-PIN	28480	5082-3080
A12A1CR6	1901-0639	4		DIODE-PIN	28480	5082-3080
A12A1CR7	1901-0639	4		DIODE-PIN	28480	5082-3080
A12A1CR8	1901-0639	4		DIODE-PIN	28480	5082-3080
<i>2427A TO 2613A</i> <i>A12A1CR9</i> <i>2708A AND ABOVE</i> <i>A12A1CR9</i>	1901-0880	7		DIODE-GEN PRP 125MA DO-35	28480	1901-0880
A12A1E1	08642-60149	2		CORE ASSEMBLY	28480	08642-60149
A12A1E2	08642-60149	2		CORE ASSEMBLY	28480	08642-60149
A12A1E3	08642-60149	2		CORE ASSEMBLY	28480	08642-60149
A12A1E4	08642-60149	2		CORE ASSEMBLY	28480	08642-60149
A12A1E5	08642-60149	2		CORE ASSEMBLY	28480	08642-60149
A12A1E6	08642-60149	2		CORE ASSEMBLY	28480	08642-60149
A12A1E7	08642-60149	2		CORE ASSEMBLY	28480	08642-60149
A12A1E8	08642-60149	2		CORE ASSEMBLY	28480	08642-60149
A12A1E9	08642-60149	2		CORE ASSEMBLY	28480	08642-60149
A12A1J1	1250-2090	4		CONNECTOR-RF SMC M SGL-HOLE-RR 50-OHM	28480	1250-2090
	08642-20081	7		ELSTMR COND SMC	28480	08642-20081
A12A1J2	1251-8759	6		CONN-POST TYPE .100-PIN-SPOG 11-CONT	28480	1251-8759
A12A1J3	08656-00033	3		CLIP SEMI-R GRND	28480	08656-00033
	1251-2194	1		CONNECTOR-SGL CONT SKT .021-IN-BSC-SZ	28480	1251-2194
A12A1L1	9100-2247	4		INDUCTOR RF-CH-MLD 100NH 10% .105DX.26LG	28480	9100-2247
A12A1L2	9100-2247	4		INDUCTOR RF-CH-MLD 100NH 10% .105DX.26LG	28480	9100-2247
A12A1L3	9100-2247	4		INDUCTOR RF-CH-MLD 100NH 10% .105DX.26LG	28480	9100-2247
A12A1L4	9100-2247	4		INDUCTOR RF-CH-MLD 100NH 10% .105DX.26LG	28480	9100-2247
A12A1L5	9140-1087	2		INDUCTOR-FIXED 120-1300 HZ	28480	9140-1087

See introduction to this section for ordering information.

\* Indicates factory selected value

Table 6-2. Replaceable Parts

Reference Designation	HP Part Number	C D	Qty	Description	Mfr Code	Mfr Part Number
A12A1Q1	1854-0946	5		TRANSISTOR NPN SI PD=290MW	28480	1854-0946
A12A1Q2	1854-0946	5		TRANSISTOR NPN SI PD=290MW	28480	1854-0946
A12A1Q3	1854-0946	5		TRANSISTOR NPN SI PD=290MW	28480	1854-0946
A12A1Q4	1854-0946	5		TRANSISTOR NPN SI PD=290MW	28480	1854-0946
A12A1Q5	1854-1009	3		TRANSISTOR NPN SI PD=580MW	28480	1854-1009
A12A1Q6	1854-0597	2		TRANSISTOR NPN 2N5943 SI TO-39 PD=1W	04713	2N5943
	1200-0173	5		INSULATOR-XSTR DAP-GL	28480	1200-0173
A12A1Q7	1858-0071	5		TRANSISTOR ARRAY PLSTC TO-116	04713	MPQ3798
A12A1R1	0699-1372	2		RESISTOR 1.47K 1% .125W F TC=0+-100	28480	0699-1372
A12A1R2	0699-1372	2		RESISTOR 1.47K 1% .125W F TC=0+-100	28480	0699-1372
A12A1R3	0698-3441	8		RESISTOR 215 1% .125W F TC=0+-100	24546	C4-1/8-T0-215R-F
A12A1R4	0698-3441	8		RESISTOR 215 1% .125W F TC=0+-100	24546	C4-1/8-T0-215R-F
A12A1R5	0699-1430	3		RESISTOR 422 1% .125W F TC=0+-100	28480	0699-1242
A12A1R6	0699-1346	0		RESISTOR 12.1 1% .125W F TC=0+-100	28480	0699-1346
A12A1R7				NOT ASSIGNED		
A12A1R8	0698-7220	9		RESISTOR 215 1% .05W F TC=0+-100	24546	C3-1/8-T0-215R-F
A12A1R9	0699-1346	0		RESISTOR 12.1 1% .125W F TC=0+-100	28480	0699-1346
A12A1R10	0699-1377	7		RESISTOR 2.37K 1% .125W F TC=0+-100	28480	0699-1377
A12A1R11	0698-4590	0		RESISTOR 422 1% .25W F TC=0+-100	24546	C5-1/4-T0-422R-F
A12A1R12	0698-3441	8		RESISTOR 215 1% .125W F TC=0+-100	24546	C4-1/8-T0-215R-F
A12A1R13	0698-3441	8		RESISTOR 215 1% .125W F TC=0+-100	24546	C4-1/8-T0-215R-F
A12A1R14	0757-0419	0		RESISTOR 681 1% .125W F TC=0+-100	24546	C4-1/8-T0-681R-F
A12A1R15	0699-1372	2		RESISTOR 1.47K 1% .125W F TC=0+-100	28480	0699-1372
A12A1R16	0699-1372	2		RESISTOR 1.47K 1% .125W F TC=0+-100	28480	0699-1372
A12A1R17	0699-1415	4		RESISTOR 100 1% .125W F TC=0+-100	28480	0699-1415
A12A1R18	0699-1415	4		RFSTOR 100 1% .125W F TC=0+-100	28480	0699-1415
A12A1R19	57-1078	9		RESISTOR 1.47K 1% .5W F TC=0+-100	28480	0757-1078
A12A1R20	0699-1415	4		RESISTOR 100 1% .125W F TC=0+-100	28480	0699-1415
A12A1R21	0699-1415	4		RESISTOR 100 1% .125W F TC=0+-100	28480	0699-1415
A12A1R22	0698-7250	5		RESISTOR 3.83K 1% .05W F TC=0+-100	24546	C3-1/8-T0-3831-F
A12A1R23	0698-7250	5		RESISTOR 3.83K 1% .05W F TC=0+-100	24546	C3-1/8-T0-3831-F
A12A1R24	0698-7250	5		RESISTOR 3.83K 1% .05W F TC=0+-100	24546	C3-1/8-T0-3831-F
A12A1R25	0698-7250	5		RESISTOR 3.83K 1% .05W F TC=0+-100	24546	C3-1/8-T0-3831-F
A12A1TP1	0360-0535	0		TERMINAL TEST POINT PCB	00000	ORDER BY DESCRIPTION
A12A1TP2	0360-0535	0		TERMINAL TEST POINT PCB	00000	ORDER BY DESCRIPTION
A12A1TP3	0360-0535	0		TERMINAL TEST POINT PCB	00000	ORDER BY DESCRIPTION
A12A1TP4	0360-0535	0		TERMINAL TEST POINT PCB	00000	ORDER BY DESCRIPTION
A12A1TP5	0360-0535	0		TERMINAL TEST POINT PCB	00000	ORDER BY DESCRIPTION
A12A1TP6	0360-0535	0		TERMINAL TEST POINT PCB	00000	ORDER BY DESCRIPTION
A12A1TP7	0360-0535	0		TERMINAL TEST POINT PCB	00000	ORDER BY DESCRIPTION
A12A1TP8				PART IS ETCHED ON CIRCUIT BOARD		
A12A1TP9				PART IS ETCHED ON CIRCUIT BOARD		
A12A1VR1	1902-1428	3		DIODE-ZNR 4.6V DO-35 PD=.4W IR=1UA	28480	1902-1428
A12A1VR2	1902-1428	3		DIODE-ZNR 4.6V DO-35 PD=.4W IR=1UA	28480	1902-1428
A12A1VR3	1902-1428	3		DIODE-ZNR 4.6V DO-35 PD=.4W IR=1UA	28480	1902-1428
A12A1VR4	1902-1428	3		DIODE-ZNR 4.6V DO-35 PD=.4W IR=1UA	28480	1902-1428
A12A1W1-W99				NOT ASSIGNED		
A12A1W100				PART IS ETCHED ON CIRCUIT BOARD		
A12A1W101				PART IS ETCHED ON CIRCUIT BOARD		
A12A1W102				PART IS ETCHED ON CIRCUIT BOARD		
A12A1W103				PART IS ETCHED ON CIRCUIT BOARD		
A12A1W104				PART IS ETCHED ON CIRCUIT BOARD		
A12A1W105				PART IS ETCHED ON CIRCUIT BOARD		
A12A1W106				PART IS ETCHED ON CIRCUIT BOARD		
A12A1W107				PART IS ETCHED ON CIRCUIT BOARD		
A12A1W108				PART IS ETCHED ON CIRCUIT BOARD		
A12A1W109				PART IS ETCHED ON CIRCUIT BOARD		
A12A1W110				PART IS ETCHED ON CIRCUIT BOARD		
A12A1W111				PART IS ETCHED ON CIRCUIT BOARD		

See introduction to this section for ordering information.

\* Indicates factory selected value

Table 6-2. Replaceable Parts

Reference Designation	HP Part Number	C D	Qty	Description	Mfr Code	Mfr Part Number
2427A TO 2612A A12A2	08642-60110	7	1	SUM MIXER/SPLITTER ASSEMBLY	28480	08642-60110
2613A AND ABOVE A12A2	08642-60210	8	1	SUM MIXER/SPLITTER ASSEMBLY	28480	08642-60210
A12A2C1	0160-3874	2		CAPACITOR-FXD 10PF +- .5PF 200VDC CER	28480	0160-3874
A12A2C2	0160-3879	7		CAPACITOR-FXD .01UF +-20% 100VDC CER	28480	0160-3879
A12A2C3	0160-3873	1		CAPACITOR-FXD 4.7PF +- .5PF 200VDC CER	28480	0160-3873
A12A2C4	0160-3879	7		CAPACITOR-FXD .01UF +-20% 100VDC CER	28480	0160-3879
A12A2C5	0160-3879	7		CAPACITOR-FXD .01UF +-20% 100VDC CER	28480	0160-3879
A12A2C6	0160-3874	2		CAPACITOR-FXD 10PF +- .5PF 200VDC CER	28480	0160-3874
A12A2C7	0160-3874	2		CAPACITOR-FXD 10PF +- .5PF 200VDC CER	28480	0160-3874
A12A2C8	0160-3879	7		CAPACITOR-FXD .01UF +-20% 100VDC CER	28480	0160-3879
A12A2C9	0160-3873	1		CAPACITOR-FXD 4.7PF +- .5PF 200VDC CER	28480	0160-3873
A12A2C10	0160-4383	0		CAPACITOR-FXD 6.8PF +- .5PF 200VDC CER	20932	5024E0200RD689D
A12A2C11	0160-3879	7		CAPACITOR-FXD .01UF +-20% 100VDC CER	28480	0160-3879
A12A2C12	0160-3874	2		CAPACITOR-FXD 10PF +- .5PF 200VDC CER	28480	0160-3874
A12A2C13	0160-3879	7		CAPACITOR-FXD .01UF +-20% 100VDC CER	28480	0160-3879
A12A2C14	0160-5961	2		CAPACITOR-FXD 22PF +-5% 50VDC CER 0+-30	28480	0160-5961
A12A2C15	0160-3879	7		CAPACITOR-FXD .01UF +-20% 100VDC CER	28480	0160-3879
A12A2C16	0160-5945	2		CAPACITOR-FXD .01UF +-10% 50VDC CER	28480	0160-5945
A12A2C17	0160-4766	3		CAPACITOR-FXD 30PF +-5% 200VDC CER 0+-30	28480	0160-4766
A12A2C18	0160-5973	6		CAPACITOR-FXD 6.8PF +- .5PF 50VDC CER	28480	0160-5973
A12A2C19	0160-5938	3	2	CAPACITOR-FXD 39PF +-5% 100VDC CER	28480	0160-5938
A12A2C20	0160-3879	7		CAPACITOR-FXD .01UF +-20% 100VDC CER	28480	0160-3879
A12A2C21	0160-5958	7		CAPACITOR-FXD 39PF +-5% 50VDC CER 0+- 30	28480	0160-5958
A12A2C22	0160-3879	7		CAPACITOR-FXD .01UF +-20% 100VDC CER	28480	0160-3879
A12A2C23	0160-4040	6		CAPACITOR-FXD 1000PF +-5% 100VDC CER	28480	0160-4040
A12A2C24	0160-4040	6		CAPACITOR-FXD 1000PF +-5% 100VDC CER	28480	0160-4040
A12A2C25	0160-0576	5		CAPACITOR-FXD .1UF +-20% 50VDC CER	28480	0160-0576
A12A2C26	0160-0576	5		CAPACITOR-FXD .1UF +-20% 50VDC CER	28480	0160-0576
A12A2C27	0160-4040	6		CAPACITOR-FXD 1000PF +-5% 100VDC CER	28480	0160-4040
A12A2C28	0160-4766	3		CAPACITOR-FXD 30PF +-5% 200VDC CER 0+-30	28480	0160-4766
A12A2C29	0160-4492	2	3	CAPACITOR-FXD 18PF +-5% 200VDC CER 0+-30	28480	0160-4492
A12A2C30	0160-4492	2		CAPACITOR-FXD 18PF +-5% 200VDC CER 0+-30	28480	0160-4492
A12A2C31	0160-3879	7		CAPACITOR-FXD .01UF +-20% 100VDC CER	28480	0160-3879
A12A2C32	0160-3874	2		CAPACITOR-FXD 10PF +- .5PF 200VDC CER	28480	0160-3874
A12A2C33	0160-6222	0		CAPACITOR-FXD .1UF +-10% 50VDC CER	28480	0160-6222
A12A2C34	0160-4801	7		CAPACITOR-FXD 100PF +-5% 100VDC CER	28480	0160-4801
A12A2C35	0160-6222	0		CAPACITOR-FXD .1UF +-10% 50VDC CER	28480	0160-6222
A12A2C36	0160-4801	7		CAPACITOR-FXD 100PF +-5% 100VDC CER	28480	0160-4801
A12A2C37	0160-6222	0		CAPACITOR-FXD .1UF +-10% 50VDC CER	28480	0160-6222
A12A2C38	0160-4801	7		CAPACITOR-FXD 100PF +-5% 100VDC CER	28480	0160-4801
A12A2C39	0160-6222	0		CAPACITOR-FXD .1UF +-10% 50VDC CER	28480	0160-6222
A12A2C40	0160-4801	7		CAPACITOR-FXD 100PF +-5% 100VDC CER	28480	0160-4801
A12A2C41	0160-6222	0		CAPACITOR-FXD .1UF +-10% 50VDC CER	28480	0160-6222
A12A2C42	0160-4801	7		CAPACITOR-FXD 100PF +-5% 100VDC CER	28480	0160-4801
A12A2C43	0160-6222	0		CAPACITOR-FXD .1UF +-10% 50 VDC CER	28480	0160-6222
A12A2C44	0160-4801	7		CAPACITOR-FXD 100PF +-5% 100VDC CER	28480	0160-4801
A12A2C45	0160-6222	0		CAPACITOR-FXD .1UF +-10% 50VDC CER	28480	0160-6222
A12A2C46	0160-5939	4		CAPACITOR-FXD 100PF +-5% 100VDC CER	28480	0160-5939
A12A2C47	0160-4535	4		CAPACITOR-FXD 1UF +-10% 50VDC CER	28480	0160-4535
A12A2FL1	9135-0214	4		FILTER-HIGH PASS PIN STYLE-TERMS	28480	9135-0214
A12A2J1	1250-2090	4		CONNECTOR-RF SMC M SGL-HOLE-RR 50-OHM	28480	1250-2090
	08642-20081	7		ELSTMR COND SMC	28480	08642-20081
A12A2J2	1250-2090	4		CONNECTOR-RF SMC M SGL-HOLE-RR 50-OHM	28480	1250-2090
	08642-20081	7		ELSTMR COND SMC	28480	08642-20081
A12A2J3	1250-2090	4		CONNECTOR-RF SMC M SGL-HOLE-RR 50-OHM	28480	1250-2090
	08642-20081	7		ELSTMR COND SMC	28480	08642-20081
A12A2J4	1251-2194	1		CONNECTOR-SGL CONT SKT .021-IN-BSC-SZ	28480	1251-2194
A12A2J5	1252-0318	9		CONN POST SKT 2	28480	1252-0318
A12A2L1	9140-0158	6		INDUCTOR RF-CH-MLD 1UH 10% .105DX.26LG	28480	9140-0158
A12A2L2	9140-0158	6		INDUCTOR RF-CH-MLD 1UH 10% .105DX.26LG	28480	9140-0158
A12A2L3	9140-0158	6		INDUCTOR RF-CH-MLD 1UH 10% .105DX.26LG	28480	9140-0158
A12A2L4	9140-1087	2		INDUCTOR-FIXED 120-1300 HZ	28480	9140-1087
A12A2L5	9140-0158	6		INDUCTOR RF-CH-MLD 1UH 10% .105DX.26LG	28480	9140-0158

See introduction to this section for ordering information.

\* Indicates factory selected value

Table 6-2. Replaceable Parts

Reference Designation	HP Part Number	C D	Qty	Description	Mfr Code	Mfr Part Number
A12A2L6	9140-0158	6		INDUCTOR RF-CH-MLD 1UH 10% .105DX.26LG	28480	9140-0158
A12A2L7	9140-0158	6		INDUCTOR RF-CH-MLD 1UH 10% .105DX.26LG	28480	9140-0158
A12A2L8	9100-0368	6	1	INDUCTOR RF-CH-MLD 330NH 10% .105DX.26LG	28480	9100-0368
A12A2L9	9135-0078	8		INDUCTOR RF-CH-MLD 82NH 7% .102DX.26LG	28480	9135-0078
A12A2L10	9100-2249	6	7	INDUCTOR RF-CH-MLD 150NH 10% .105DX.26LG	28480	9100-2249
A12A2L11	9135-0078	8		INDUCTOR RF-CH-MLD 82NH 7% .102DX.26LG	28480	9135-0078
A12A2L12	9140-1087	2		INDUCTOR-FIXED 120-1300 HZ	28480	9140-1087
A12A2L13	9140-0158	6		INDUCTOR RF-CH-MLD 1UH 10% .105DX.26LG	28480	9140-0158
A12A2L14	9135-0072	2		INDUCTOR RF-CH-MLD 56NH 5% .102DX.26LG	28480	9135-0072
A12A2L15	9135-0072	2		INDUCTOR RF-CH-MLD 56NH 5% .102DX.26LG	28480	9135-0072
A12A2L16	9135-0070	0		INDUCTOR RF-CH-MLD 24NH 7% .102DX.26LG	28480	9135-0070
A12A2L17				PART IS ETCHED TRACE ON CIRCUIT BOARD		
A12A2L18				PART IS ETCHED TRACE ON CIRCUIT BOARD		
A12A2L19				PART IS ETCHED TRACE ON CIRCUIT BOARD		
A12A2L20				PART IS ETCHED TRACE ON CIRCUIT BOARD		
A12A2L21				PART IS ETCHED TRACE ON CIRCUIT BOARD		
A12A2L22				PART IS ETCHED TRACE ON CIRCUIT BOARD		
A12A2MP1	08656-00033	3		CLIP SEMI-R GRND	28480	08656-00033
A12A2MP2	0340-0840	8		INSULATOR SLBL-LAC-CMPD	28480	0340-0840
A12A2Q1	1854-1009	3		TRANSISTOR NPN SI PD=580MW	28480	1854-1009
A12A2Q2	1854-0946	5		TRANSISTOR NPN SI PD=290MW	28480	1854-0946
A12A2Q3	1854-0946	5		TRANSISTOR NPN SI PD=290MW	28480	1854-0946
A12A2Q4	1854-0946	5		TRANSISTOR NPN SI PD=290MW	28480	1854-0946
A12A2Q5	1854-0946	5		TRANSISTOR NPN SI PD=290MW	28480	1854-0946
A12A2Q6	1854-0946	5		TRANSISTOR NPN SI PD=290MW	28480	1854-0946
A12A2Q7	1854-0720	3		TRANSISTOR NPN SI PD=500MW FT=4GHZ	28480	1854-0720
A12A2Q8	1854-1008	2		TRANSISTOR NPN SI PD=600MW FT=2GHZ	28480	1854-1008
A12A2Q9	1854-0946	5		TRANSISTOR NPN SI PD=290MW	28480	1854-0946
A12A2Q10	1854-0946	5		TRANSISTOR NPN SI PD=290MW	28480	1854-0946
A12A2R1	0698-7205	0		RESISTOR 51.1 1% .05W F TC=0+-100	24546	C3-1/8-T0-51R1-F
A12A2R2	0757-0417	8		RESISTOR 562 1% .125W F TC=0+-100	24546	C4-1/8-T0-562R-F
A12A2R3	0699-1423	4		RESISTOR 215 1% .125W F TC=0+-100	28480	0699-1423
A12A2R4	0698-7205	0		RESISTOR 51.1 1% .05W F TC=0+-100	24546	C3-1/8-T0-51R1-F
A12A2R5	0698-4588	6		RESISTOR 383 1% .25W F TC=0+-100	24546	C5-1/4-T0-383R-F
A12A2R6	0699-1423	4		RESISTOR 215 1% .125W F TC=0+-100	28480	0699-1423
A12A2R7	0698-7205	0		RESISTOR 51.1 1% .05W F TC=0+-100	24546	C3-1/8-T0-51R1-F
A12A2R8	0698-7205	0		RESISTOR 51.1 1% .05W F TC=0+-100	24546	C3-1/8-T0-51R1-F
A12A2R9	0699-1423	4		RESISTOR 215 1% .125W F TC=0+-100	28480	0699-1423
A12A2R10	0757-0419	0		RESISTOR 681 1% .125W F TC=0+-100	24546	C4-1/8-T0-681R-F
A12A2R11	0698-7205	0		RESISTOR 51.1 1% .05W F TC=0+-100	24546	C3-1/8-T0-51R1-F
A12A2R12	0699-1423	4		RESISTOR 215 1% .125W F TC=0+-100	28480	0699-1423
A12A2R13	0757-0417	8		RESISTOR 562 1% .125W F TC=0+-100	24546	C4-1/8-T0-562R-F
A12A2R14	0698-7205	0		RESISTOR 51.1 1% .05W F TC=0+-100	24546	C3-1/8-T0-51R1-F
A12A2R15	0699-1423	4		RESISTOR 215 1% .125W F TC=0+-100	28480	0699-1423
A12A2R16	0698-0082	7		RESISTOR 464 1% .125W F TC=0+-100	24546	C4-1/8-T0-4640-F
A12A2R17	0698-7205	0		RESISTOR 51.1 1% .05W F TC=0+-100	24546	C3-1/8-T0-51R1-F
A12A2R18	0699-1423	4		RESISTOR 215 1% .125W F TC=0+-100	28480	0699-1423
A12A2R19	0698-3401	0		RESISTOR 215 1% .5W F TC=0+-100	28480	0698-3401
A12A2R20	0699-1432	5		RESISTOR 511 1% .125W F TC=0+-100	28480	0699-1432
A12A2R21	0699-1423	4		RESISTOR 215 1% .125W F TC=0+-100	28480	0699-1423
A12A2R22	0698-3102	8		RESISTOR 237 1% .5W F TC=0+-100	28480	0698-3102
A12A2R23	0698-3102	8		RESISTOR 237 1% .5W F TC=0+-100	28480	0698-3102
A12A2R24	0699-1363	1		RESISTOR 61.9 1% .125W F TC=0+-100	28480	0699-1213
A12A2R25	0699-1828	3	2	RESISTOR 105 1% .2W C TC=0+-200	28480	0699-1828
A12A2R26	0699-1828	3		RESISTOR 105 1% .125W F TC=0+-100	28480	0699-1828
A12A2R27	0699-1361	9		RESISTOR 51.1 1% .125W F TC=0+-100	28480	0699-1361
A12A2R28	0698-4588	6		RESISTOR 383 1% .25W F TC=0+-100	24546	C5-1/4-T0-383R-F
A12A2R29	0699-1346	0		RESISTOR 12.1 1% .125W F TC=0+-100	28480	0699-1346
A12A2R30	0698-7229	8		RESISTOR 511 1% .05W F TC=0+-100	24546	C3-1/8-T0-511R-F
A12A2R31	0698-7245	8		RESISTOR 2.37K 1% .05W F TC=0+-100	24546	C3-1/8-T0-2371-F
A12A2R32	0698-7217	4		RESISTOR 162 1% .05W F TC=0+-100	24546	C3-1/8-T0-162R-F
A12A2R33	0698-4588	6		RESISTOR 383 1% .25W F TC=0+-100	24546	C5-1/4-T0-383R-F
A12A2R34	0699-1346	0		RESISTOR 12.1 1% .125W F TC=0+-100	28480	0699-1346
A12A2R35	0757-0418	9		RESISTOR 619 1% .125W F TC=0+-100	24546	C4-1/8-T0-619R-F
A12A2R36	0757-0399	5		RESISTOR 82.5 1% .125W F TC=0+-100	24546	C4-1/8-T0-82R5-F
A12A2R37	0699-0443	6	1	RESISTOR 21.5 1% .05W F TC=0+-100	28480	0699-0443
A12A2R38	0699-1423	4		RESISTOR 215 1% .125W F TC=0+-100	28480	0699-1423
A12A2R39	0698-0082	7		RESISTOR 464 1% .125W F TC=0+-100	24546	C4-1/8-T0-4640-F
A12A2R40	0699-1346	0		RESISTOR 12.1 1% .125W F TC=0+-100	28480	0699-1346

See introduction to this section for ordering information.

\* Indicates factory selected value

Table 6-2. Replaceable Parts

Reference Designation	HP Part Number	C D	Qty	Description	Mfr Code	Mfr Part Number
A12A2R41	0699-1346	0		RESISTOR 12.1 1% .125W F TC=0+-100	28480	0699-1346
A12A2R42	0699-1423	4		RESISTOR 215 1% .125W F TC=0+-100	28480	0699-1423
A12A2R43	0699-1346	0		RESISTOR 12.1 1% .125W F TC=0+-100	26654	3C120J
A12A2R44	0699-1372	2		RESISTOR 1.47K 1% .125W F TC=0+-100	28480	0699-1372
A12A2R45	0699-1372	2		RESISTOR 1.47K 1% .125W F TC=0+-100	28480	0699-1372
A12A2R46	0699-1372	2		RESISTOR 1.47K 1% .125W F TC=0+-100	28480	0699-1372
A12A2R47	0699-1372	2		RESISTOR 1.47K 1% .125W F TC=0+-100	28480	0699-1372
A12A2R48	0699-1372	2		RESISTOR 1.47K 1% .125W F TC=0+-100	28480	0699-1372
A12A2R49	0699-1372	2		RESISTOR 1.47K 1% .125W F TC=0+-100	28480	0699-1372
A12A2R50	0699-1432	5		RESISTOR 511 1% .125W F TC=0+-100	28480	0699-1432
A12A2R51	0698-7205	0		RESISTOR 51.1 1% .05W F TC=0+-100	24546	C3-1/8-TO-51R1-F
A12A2R52	0698-7205	0		RESISTOR 51.1 1% .05W F TC=0+-100	24546	C3-1/8-TO-51R1-F
A12A2R53	0698-7205	0		RESISTOR 51.1 1% .05W F TC=0+-100	24546	C3-1/8-TO-51R1-F
A12A2R54	0698-7205	0		RESISTOR 51.1 1% .05W F TC=0+-100	24546	C3-1/8-TO-51R1-F
A12A2R55	0698-7205	0		RESISTOR 51.1 1% .05W F TC=0+-100	24546	C3-1/8-TO-51R1-F
A12A2R56	0698-7205	0		RESISTOR 51.1 1% .05W F TC=0+-100	24546	C3-1/8-TO-51R1-F
A12A2R57	0699-1361	9		RESISTOR 51.1 1% .125W F TC=0+-100	28480	0699-1361
A12A2R58	0698-7191	3	1	RESISTOR 13.3 1% .05W F TC=0+-100	24546	C3-1/8-TO-16R3-F
A12A2T1	9100-4365	1		TRANSFORMER-RF INPUT Z:50 OHMS;Z RATIO:1	28480	9100-4365
A12A2VR1	1902-1428	3		DIODE-ZNR 4.6V DO-35 PD=.4W IR=1UA	28480	1902-1428
A12A2VR2	1902-1428	3		DIODE-ZNR 4.6V DO-35 PD=.4W IR=1UA	28480	1902-1428
A12A2VR3	1902-1428	3		DIODE-ZNR 4.6V DO-35 PD=.4W IR=1UA	28480	1902-1428
A12A2VR4	1902-1428	3		DIODE-ZNR 4.6V DO-35 PD=.4W IR=1UA	28480	1902-1428
A12A2VR5	1902-1428	3		DIODE-ZNR 4.6V DO-35 PD=.4W IR=1UA	28480	1902-1428
A12A2VR6	1902-1428	3		DIODE-ZNR 4.6V DO-35 PD=.4W IR=1UA	28480	1902-1428
A12A2VR7	1902-1428	3		DIODE-ZNR 4.6V DO-35 PD=.4W IR=1UA	28480	1902-1428
A12A2VR8	1902-1428	3		DIODE-ZNR 4.6V DO-35 PD=.4W IR=1UA	28480	1902-1428
A12A2Z1	0955-0212	1	1	MIXER-DOUBLE BALANCED FREQ RANGE: LO	28480	0955-0212
	1251-3172	7		CONNECTOR-SGL CONT SKT .03-IN-BSC-SZ RND	28480	1251-3172
A12A2Z2	0960-0682	0		POWER SPLITTER-RF PC MOUNT: 10-1500MHZ	28480	0960-0682
	1251-3172	7		CONNECTOR-SGL CONT SKT .03-IN-BSC-SZ RND	28480	1251-3172

See introduction to this section for ordering information.

\* Indicates factory selected value





Table 6-2. Replaceable Parts

Reference Designation	HP Part Number	C D	Qty	Description	Mfr Code	Mfr Part Number
2427A TO 2529A A12A3	08642-60111	8	1	SUM PHASE DETECTOR/DIVIDER ASSEMBLY	28480	08642-60111
2530A TO 2535A A12A3	08642-60211	9	1	SUM PHASE DETECTOR/DIVIDER ASSEMBLY	28480	08642-60211
2543A AND ABOVE A12A3	08642-60311	0	1	SUM PHASE DETECTOR/DIVIDER ASSEMBLY	28480	08642-60311
A12A3C1	0160-4389	6		CAPACITOR-FXD 100PF +-5PF 200VDC CER	28480	0160-4389
A12A3C2	0160-0576	5		CAPACITOR-FXD .1UF +-20% 50VDC CER	28480	0160-0576
A12A3C3	0160-4389	6		CAPACITOR-FXD 100PF +-5PF 200VDC CER	28480	0160-4389
A12A3C4	0160-0576	5		CAPACITOR-FXD .1UF +-20% 50VDC CER	28480	0160-0576
A12A3C5	0160-4040	6		CAPACITOR-FXD 1000PF +-5% 100VDC CER	28480	0160-4040
A12A3C6	0160-3879	7		CAPACITOR-FXD .01UF +-20% 100VDC CER	28480	0160-3879
A12A3C7	0160-3879	7		CAPACITOR-FXD .01UF +-20% 100VDC CER	28480	0160-3879
A12A3C8	0160-3879	7		CAPACITOR-FXD .01UF +-20% 100VDC CER	28480	0160-3879
A12A3C9	0160-4040	6		CAPACITOR-FXD 1000PF +-5% 100VDC CER	28480	0160-4040
A12A3C10	0160-0576	5		CAPACITOR-FXD .1UF +-20% 50VDC CER	28480	0160-0576
A12A3C11	0160-4040	6		CAPACITOR-FXD 1000PF +-5% 100VDC CER	28480	0160-4040
A12A3C12	0160-5957	6		CAPACITOR-FXD 47PF +-5% 50VDC CER 0+-30	28480	0160-5957
A12A3C13	0160-5957	6		CAPACITOR-FXD 47PF +-5% 50VDC CER 0+-30	28480	0160-5957
A12A3C14	0160-5965	6		CAPACITOR-FXD 150PF +-5% 50VDC CER 0+-30	28480	0160-5965
A12A3C15	0160-5968	9		CAPACITOR-FXD 82PF +-5% 50VDC CER 0+-30	28480	0160-5968
A12A3C16	0160-4767	4	6	CAPACITOR-FXD 20PF +-5% 200VDC CER 0+-30	28480	0160-4767
A12A3C17	0121-0449	9		CAPACITOR-V TRMR-CER 3.5-10PF 63V PC-MTG	28480	0121-0449
A12A3C18	0160-4385	2		CAPACITOR-FXD 15PF +-5% 200VDC CER 0+-30	28480	0160-4385
A12A3C19	0160-5939	4	2	CAPACITOR-FXD 100PF +-5% 100VDC CER	28480	0160-5939
A12A3C20	0160-5965	6		CAPACITOR-FXD 150PF +-5% 50VDC CER	28480	0160-5965
A12A3C21	0160-5939	4		CAPACITOR-FXD 100PF +-5% 100VDC CER	28480	0160-5939
A12A3C22	0160-5038	4		CAPACITOR-FXD 3300PF +-10% 100VDC CER	28480	0160-5038
A12A3C23	0160-0576	5		CAPACITOR-FXD .1UF +-20% 50VDC CER	28480	0160-0576
A12A3C24	0160-4535	4		CAPACITOR-FXD 1UF +-10% 50VDC CER	28480	0160-4535
A12A3C25	0160-4389	6		CAPACITOR-FXD 100PF +-5PF 200VDC CER	28480	0160-4389
A12A3C26	0160-4389	6		CAPACITOR-FXD 100PF +-5PF 200VDC CER	28480	0160-4389
A12A3C27	0160-4040	6		CAPACITOR-FXD 1000PF +-5% 100VDC CER	28480	0160-4040
A12A3C28	0160-3914	1	2	CAPACITOR-FXD .01UF +-10% 100VDC CER	28480	0160-3914
A12A3C29	0160-3875	3		CAPACITOR-FXD 22PF +-5% 200VDC CER 0+-30	28480	0160-3875
A12A3C30	0160-3914	1		CAPACITOR-FXD .01UF +-10% 100VDC CER	28480	0160-3914
A12A3C31	0160-0576	5		CAPACITOR-FXD .1UF +-20% 50VDC CER	28480	0160-0576
A12A3C32	0160-3879	7		CAPACITOR-FXD .01UF +-20% 100VDC CER	28480	0160-3879
A12A3C33	0160-0576	5		CAPACITOR-FXD .1UF +-20% 50VDC CER	28480	0160-0576
A12A3C34	0160-0576	5		CAPACITOR-FXD .1UF +-20% 50VDC CER	28480	0160-0576
A12A3C35	0180-0089	7		CAPACITOR-FXD 10UF+50-10% 150VDC AL	56289	30D106F150DD2
A12A3C36	0180-0491	5		CAPACITOR-FXD 10UF+-20% 25VDC TA	28480	0180-0491
A12A3C37	0180-0491	5		CAPACITOR-FXD 10UF+-20% 25VDC TA	28480	0180-0491
A12A3C38	0180-0491	5		CAPACITOR-FXD 10UF+-20% 25VDC TA	28480	0180-0491
A12A3C39	0180-0491	5		CAPACITOR-FXD 10UF+-20% 25VDC TA	28480	0180-0491
A12A3C40	0160-4535	4		CAPACITOR-FXD 1UF +-10% 50VDC CER	28480	0160-4535
A12A3C41	0160-0168	1		CAPACITOR-FXD .1UF +-10% 200VDC POLYE	28480	0160-0168
A12A3C42	0160-0576	5		CAPACITOR-FXD .1UF +-20% 50VDC CER	28480	0160-0576
A12A3C43	0160-4547	8		CAPACITOR-FXD 150PF +-5% 200VDC CER	28480	0160-4547
A12A3C44-C47				NOT ASSIGNED		
A12A3C48	0160-0576	5		CAPACITOR-FXD .1UF +-20% 50VDC CER	28480	0160-0576
A12A3C49	0160-0576	5		CAPACITOR-FXD .1UF +-20% 50VDC CER	28480	0160-0576
A12A3C50	0160-0576	5		CAPACITOR-FXD .1UF +-20% 50VDC CER	28480	0160-0576
A12A3C51	0160-0576	5		CAPACITOR-FXD .1UF +-20% 50VDC CER	28480	0160-0576
A12A3C52	0160-0576	5		CAPACITOR-FXD .1UF +-20% 50VDC CER	28480	0160-0576
A12A3C53	0160-3879	7		CAPACITOR-FXD .01UF +-20% 100VDC CER	28480	0160-3879
A12A3C54	0160-3879	7		CAPACITOR-FXD .01UF +-20% 100VDC CER	28480	0160-3879
A12A3C55	0160-0576	5		CAPACITOR-FXD .1UF +-20% 50VDC CER	28480	0160-0576
A12A3C56	0160-0576	5		CAPACITOR-FXD .1UF +-20% 50VDC CER	28480	0160-0576
A12A3C57-C100				NOT ASSIGNED		
A12A3C101	0160-4040	6		CAPACITOR-FXD 1000PF +-5% 100VDC CER	28480	0160-4040
A12A3C102	0160-4389	6		CAPACITOR-FXD 100PF +-5PF 200VDC CER	28480	0160-4389
A12A3C103	0160-4040	6		CAPACITOR-FXD 1000PF +-5% 100VDC CER	28480	0160-4040
A12A3C104	0160-4040	6		CAPACITOR-FXD 1000PF +-5% 100VDC CER	28480	0160-4040
A12A3C105	0160-4389	6		CAPACITOR-FXD 100PF +-5PF 200VDC CER	28480	0160-4389
A12A3C106	0160-4389	6		CAPACITOR-FXD 100PF +-5PF 200VDC CER	28480	0160-4389
A12A3C107	0160-4040	6		CAPACITOR-FXD 1000PF +-5% 100VDC CER	28480	0160-4040
A12A3C108	0160-4040	6		CAPACITOR-FXD 1000PF +-5% 100VDC CER	28480	0160-4040
A12A3C109	0160-4511	6		CAPACITOR-FXD 220PF +-5% 200VDC CER	28480	0160-4511
A12A3C110	0160-4511	6		CAPACITOR-FXD 220PF +-5% 200VDC CER	28480	0160-4511
A12A3C111	0160-4040	6		CAPACITOR-FXD 1000PF +-5% 100VDC CER	28480	0160-4040

See introduction to this section for ordering information.

\* Indicates factory selected value

Table 6-2. Replaceable Parts

Reference Designation	HP Part Number	C D	Qty	Description	Mfr Code	Mfr Part Number
A12A3C112	0160-4040	6		CAPACITOR-FXD 1000PF +-5% 100VDC CER	28480	0160-4040
A12A3C113	0160-4040	6		CAPACITOR-FXD 1000PF +-5% 100VDC CER	28480	0160-4040
A12A3C114	0160-4040	6		CAPACITOR-FXD 1000PF +-5% 100VDC CER	28480	0160-4040
A12A3C115	0160-4040	6		CAPACITOR-FXD 1000PF +-5% 100VDC CER	28480	0160-4040
A12A3C116	0160-4040	6		CAPACITOR-FXD 1000PF +-5% 100VDC CER	28480	0160-4040
A12A3C117	0160-4040	6		CAPACITOR-FXD 1000PF +-5% 100VDC CER	28480	0160-4040
A12A3C118	0160-4040	6		CAPACITOR-FXD 1000PF +-5% 100VDC CER	28480	0160-4040
A12A3C119	0160-4040	6		CAPACITOR-FXD 1000PF +-5% 100VDC CER	28480	0160-4040
A12A3C120	0160-0576	5		CAPACITOR-FXD .1UF +-20% 50VDC CER	28480	0160-0576
A12A3C121	0160-0576	5		CAPACITOR-FXD .1UF +-20% 50VDC CER	28480	0160-0576
A12A3C122	0160-0576	5		CAPACITOR-FXD .1UF +-20% 50VDC CER	28480	0160-0576
A12A3C123	0160-0576	5		CAPACITOR-FXD .1UF +-20% 50VDC CER	28480	0160-0576
A12A3C124	0160-0576	5		CAPACITOR-FXD .1UF +-20% 50VDC CER	28480	0160-0576
A12A3C125	0160-0576	5		CAPACITOR-FXD .1UF +-20% 50VDC CER	28480	0160-0576
A12A3C126	0160-0576	5		CAPACITOR-FXD .1UF +-20% 50VDC CER	28480	0160-0576
A12A3C127	0160-0576	5		CAPACITOR-FXD .1UF +-20% 50VDC CER	28480	0160-0576
A12A3C128	0160-0576	5		CAPACITOR-FXD .1UF +-20% 50VDC CER	28480	0160-0576
2427A TO 2529A A12A3C129	0160-0576	5		CAPACITOR-FXD .1UF +-20% 50VDC CER	28480	0160-0576
2530A AND ABOVE A12A3C129				NOT ASSIGNED		
A12A3C130	0160-0576	5		CAPACITOR-FXD .1UF +-20% 50VDC CER	28480	0160-0576
A12A3C131	0160-0576	5		CAPACITOR-FXD .1UF +-20% 50VDC CER	28480	0160-0576
A12A3C132	0160-4040	6		CAPACITOR-FXD 1000PF +-5% 100VDC CER	28480	0160-4040
2427A TO 2535A A12A3C133	0160-0576	5		CAPACITOR-FXD .1UF +-20% 50VDC CER	28480	0160-0576
2543A AND ABOVE A12A3C133	0180-2618	2		CAPACITOR-FXD 33UF +-10% 10 VDC TA	25088	D33GS1B10K
A12A3C134	0160-0576	5		CAPACITOR-FXD .1UF +-20% 50VDC CER	28480	0160-0576
2427A TO 2535A A12A3C135	0160-0576	5		CAPACITOR-FXD .1UF +-20% 50VDC CER	28480	0160-0576
2543A AND ABOVE A12A3C135	0180-2618	2		CAPACITOR-FXD 33UF +-10% 10 VDC TA	25088	D33GS1B10K
A12A3C136	0160-0576	5		CAPACITOR-FXD .1UF +-20% 50VDC CER	28480	0160-0576
A12A3C137	0160-0576	5		CAPACITOR-FXD .1UF +-20% 50VDC CER	28480	0160-0576
A12A3C138	0160-4389	6		CAPACITOR-FXD 100PF +-5PF 200VDC CER	28480	0160-4389
A12A3C139	0160-4511	6		CAPACITOR-FXD 220PF +-5% 200VDC CER	28480	0160-4511
2427A TO 2529A A12A3C140				NOT ASSIGNED		
A12A3C141				NOT ASSIGNED		
2530A TO 2535A A12A3C140	0160-4040	6		CAPACITOR-FXD 1000PF +-5% 100VDC CER	28480	0160-4040
A12A3C141	0160-4040	6		CAPACITOR-FXD 1000PF +-5% 100VDC CER	28480	0160-4040
2543A AND ABOVE A12A3C140				NOT ASSIGNED		
A12A3C141				NOT ASSIGNED		
2427A TO 2529A A12A3C142-C147				NOT ASSIGNED		
2530A AND ABOVE A12A3C142	0160-5975	8		CAPACITOR-FXD .22UF +80-20% 25VDC CER	28480	0160-5975
A12A3C143	0160-5975	8		CAPACITOR-FXD .22UF +80-20% 25VDC CER	28480	0160-5975
A12A3C144	0160-5975	8		CAPACITOR-FXD .22UF +80-20% 25VDC CER	28480	0160-5975
A12A3C145	0160-3874	2		CAPACITOR-FXD 10PF +- .5PF 200VDC CER	28480	0160-3874
A12A3C146	0160-3874	2		CAPACITOR-FXD 10PF +- .5PF 200VDC CER	28480	0160-3874
A12A3C147	0160-3874	2		CAPACITOR-FXD 10PF +- .5PF 200VDC CER	28480	0160-3874
A12A3CR1	1901-1085	6		DIODE-SM SIG SCHOTTKY	28480	1901-1085
A12A3CR2	1901-1085	6		DIODE-SM SIG SCHOTTKY	28480	1901-1085
A12A3CR3	1901-0050	3		DIODE-SWITCHING 80V 200MA 2NS DO-35	28480	1901-0050
A12A3CR4	1901-0050	3		DIODE-SWITCHING 80V 200MA 2NS DO-35	28480	1901-0050
A12A3CR5	1901-0050	3		DIODE-SWITCHING 80V 200MA 2NS DO-35	28480	1901-0050
A12A3CR6-CR101				NOT ASSIGNED		
A12A3CR102	1901-0639	4		DIODE-PIN	28480	5082-3080
A12A3CR103	1901-0639	4		DIODE-PIN	28480	5082-3080
A12A3CR104	1901-0639	4		DIODE-PIN	28480	5082-3080
A12A3CR105				NOT ASSIGNED		
A12A3CR106	1901-0639	4		DIODE-PIN	28480	5082-3080
A12A3DS1	1990-1110	5		LED-LAMP LUM-INT=1.5MCD IF=20MA-MAX	28480	1990-1110

See introduction to this section for ordering information.

\* Indicates factory selected value

Table 6-2. Replaceable Parts

Reference Designation	HP Part Number	C D	Qty	Description	Mfr Code	Mfr Part Number
A12A3FL1	9135-0214	4		FILTER-HIGH PASS PIN STYLE-TERMS	28480	9135-0214
A12A3FL2	9135-0214	4		FILTER-HIGH PASS PIN STYLE-TERMS	28480	9135-0214
A12A3FL3	9135-0214	4		FILTER-HIGH PASS PIN STYLE-TERMS	28480	9135-0214
A12A3FL4	9135-0214	4		FILTER-HIGH PASS PIN STYLE-TERMS	28480	9135-0214
A12A3FL5	9135-0214	4		FILTER-HIGH PASS PIN STYLE-TERMS	28480	9135-0214
A12A3FL6	9135-0214	4		FILTER-HIGH PASS PIN STYLE-TERMS	28480	9135-0214
A12A3FL7	9135-0214	4		FILTER-HIGH PASS PIN STYLE-TERMS	28480	9135-0214
A12A3FL8	9135-0214	4		FILTER-HIGH PASS PIN STYLE-TERMS	28480	9135-0214
A12A3FL9	9135-0214	4		FILTER-HIGH PASS PIN STYLE-TERMS	28480	9135-0214
A12A3FL10	9135-0214	4		FILTER-HIGH PASS PIN STYLE-TERMS	28480	9135-0214
A12A3FL11	9135-0214	4		FILTER-HIGH PASS PIN STYLE-TERMS	28480	9135-0214
A12A3FL12	9135-0214	4		FILTER-HIGH PASS PIN STYLE-TERMS	28480	9135-0214
A12A3FL13	9135-0214	4		FILTER-HIGH PASS PIN STYLE-TERMS	28480	9135-0214
A12A3FL14	9135-0214	4		FILTER-HIGH PASS PIN STYLE-TERMS	28480	9135-0214
A12A3J1	1251-8248	8		CONN-POST TYPE .100-PIN-SPCG 26-CONT	28480	1251-8248
	1251-5595	2		POLARIZING KEY-POST CONN	28480	1251-5595
A12A3J2	1250-2090	4		CONNECTOR-RF SMC M SGL-HOLE-RR 50-OHM	28480	1250-2090
	08642-20081	7		ELSTMR COND SMC	28480	08642-20081
A12A3J3	1250-2090	4		CONNECTOR-RF SMC M SGL-HOLE-RR 50-OHM	28480	1250-2090
	08642-20081	7		ELSTMR COND SMC	28480	08642-20081
A12A3J4	1250-2090	4		CONNECTOR-RF SMC M SGL-HOLE-RR 50-OHM	28480	1250-2090
	08642-20081	7		ELSTMR COND SMC	28480	08642-20081
A12A3J5	1250-2090	4		CONNECTOR-RF SMC M SGL-HOLE-RR 50-OHM	28480	1250-2090
	08642-20081	7		ELSTMR COND SMC	28480	08642-20081
A12A3J6	1250-2090	4		CONNECTOR-RF SMC M SGL-HOLE-RR 50-OHM	28480	1250-2090
	08642-20078	2		ELSTMR CON SMC C	28480	08642-20078
A12A3J7	1251-8759	6		CONN-POST TYPE .100-PIN-SPCG 11-CONT	28480	1251-8759
A12A3J8	1252-0318	9		CONN POST SKT 2	28480	1252-0318
A12A3L1	9140-1087	2		INDUCTOR-FIXED 120-1300 HZ	28480	9140-1087
A12A3L2	9140-0477	2	1	INDUCTOR RF-CH-MLD 270NH 1% .105DX.26LG	28480	9140-0477
A12A3L3	9100-0593	9	3	INDUCTOR RF-CH-MLD 470NH 5% .105DX.26LG	28480	9100-0593
A12A3L4	9100-0593	9		INDUCTOR RF-CH-MLD 470NH 5% .105DX.26LG	28480	9100-0593
A12A3L5	9100-1631	8		INDUCTOR RF-CH-MLD 56UH 5% .166DX.385LG	28480	9100-1631
A12A3L6	9140-0400	1		INDUCTOR RF-CH-MLD 8.2UH 5% .166DX.385LG	28480	9140-0400
A12A3L7	9140-1087	2		INDUCTOR-FIXED 120-1300 HZ	28480	9140-1087
A12A3L8	9140-0299	6		INDUCTOR RF-CH-MLD 820NH 5% .105DX.26LG	28480	9140-0299
A12A3L9	9140-0531	9		INDUCTOR RF-CH-MLD 1UH 5% .105DX.26LG	28480	9140-0531
A12A3L10	9140-0507	9		INDUCTOR RF-CH-MLD 56UH 5% .105DX.26LG	28480	9140-0507
A12A3L11-L100				NOT ASSIGNED		
A12A3L101	9135-0079	9		INDUCTOR RF-CH-MLD 100NH 5% .102DX.26LG	28480	9135-0079
2427A TO 2535A A12A3L102	9140-1087	4		INDUCTOR-FIXED 120-1300 HZ	28480	9140-1087
2543A AND ABOVE A12A3L102	9140-1088	3		INDUCTOR-FIXED 4 MHZ	28480	9140-1088
A12A3L103	9140-1087	2		INDUCTOR-FIXED 120-1300 HZ	28480	9140-1087
A12A3L104	9135-0079	9		INDUCTOR RF-CH-MLD 100NH 5% .102DX.26LG	28480	9135-0079
A12A3L105	9140-1087	2		INDUCTOR-FIXED 120-1300 HZ	28480	9140-1087
A12A3L106	9140-0507	9		INDUCTOR RF-CH-MLD 56UH 5% .105DX.26LG	28480	9140-0507
A12A3L107	9140-1087	2		INDUCTOR-FIXED 120-1300 HZ	28480	9140-1087
A12A3L108	9135-0079	9		INDUCTOR RF-CH-MLD 100NH 5% .102DX.26LG	28480	9135-0079
A12A3L109	9100-2254	3		INDUCTOR RF-CH-MLD 390NH 10% .105DX.26LG	28480	9100-2254
A12A3L110	9140-1087	2		INDUCTOR-FIXED 120-1300 HZ	28480	9140-1087
2427A TO 2535A A12A3L111	9100-3922	4		INDUCTOR-FIXED 120-1300 HZ	28480	9100-3922
2543A AND ABOVE A12A3L111	9140-0891	4		INDUCTOR FIXED INDUCTANCE 27UH +-15% @1	28480	9140-0891
2427A TO 2529A A12A3L112				NOT ASSIGNED		
2530A AND ABOVE A12A3L112	9140-0517	1		INDUCTOR RF-CH-MLD 180NH 5% .105DX-.26L	28480	9140-0517

See introduction to this section for ordering information.

\* Indicates factory selected value

Table 6-2. Replaceable Parts

Reference Designation	HP Part Number	C D	Qty	Description	Mfr Code	Mfr Part Number
A12A3Q1	1854-0637	1		TRANSISTOR NPN 2N2219A SI TO-5 PD=800Mw	01295	2N2219A
	1200-0173	5		INSULATOR-XSTR DAP-GL	28480	1200-0173
	1205-0011	0		HEAT SINK TO-5/TO-39-CS	28480	1205-0011
	1854-0720	3		TRANSISTOR NPN SI PD=500Mw FT=4GHZ	28480	1854-0720
A12A3Q2	1854-0720	3		TRANSISTOR NPN SI PD=500Mw FT=4GHZ	28480	1854-0720
A12A3Q3	1854-0720	3		TRANSISTOR NPN SI PD=500Mw FT=4GHZ	28480	1854-0720
A12A3Q4	1854-0637	1		TRANSISTOR NPN 2N2219A SI TO-5 PD=800Mw	01295	2N2219A
	1200-0173	5		INSULATOR-XSTR DAP-GL	28480	1200-0173
	1205-0011	0		HEAT SINK TO-5/TO-39-CS	28480	1205-0011
	1854-0720	3		TRANSISTOR NPN SI PD=500Mw FT=4GHZ	28480	1854-0720
A12A3Q5	1854-0813	5		TRANSISTOR NPN 2N3501S SI TO-39 PD=1W	28480	1854-0813
A12A3Q6	1200-0173	5		INSULATOR-XSTR DAP-GL	28480	1200-0173
	1205-0011	0		HEAT SINK TO-5/TO-39-CS	28480	1205-0011
A12A3Q7-Q100				NOT ASSIGNED		
A12A3Q101	1854-0810	2		TRANSISTOR NPN SI PD=625Mw FT=200MHZ	28480	1854-0810
2427A TO 2529A A12A3Q102-Q104 2530A AND ABOVE				NOT ASSIGNED		
A12A3Q102	1854-0810	2		TRANSISTOR NPN SI PD=625Mw FT=200MHZ	28480	1854-0810
A12A3Q103	1854-0810	2		TRANSISTOR NPN SI PD=625Mw FT=200MHZ	28480	1854-0810
A12A3Q104	1854-0810	2		TRANSISTOR NPN SI PD=625Mw FT=200MHZ	28480	1854-0810
A12A3R1	0698-7229	8		RESISTOR 511 1% .05W F TC=0+-100	24546	C3-1/8-TO-511R-F
A12A3R2	0698-7220	9		RESISTOR 215 1% .05W F TC=0+-100	24546	C3-1/8-TO-215R-F
A12A3R3	0698-7245	8		RESISTOR 2.37K 1% .05W F TC=0+-100	24546	C3-1/8-TO-2371-F
A12A3R4	0698-4588	6		RESISTOR 383 1% .25W F TC=0+-100	24546	C5-1/4-TO-383R-F
A12A3R5	0699-1346	0		RESISTOR 12.1 1% .125W F TC=0+-100	28480	0699-1346
A12A3R6	0698-7231	2		RESISTOR 619 1% .05W F TC=0+-100	24546	C3-1/8-TO-619R-F
A12A3R7	0699-1346	0		RESISTOR 12.1 1% .125W F TC=0+-100	28480	0699-1346
A12A3R8	0757-1090	5		RESISTOR 261 1% .5W F TC=0+-100	28480	0757-1090
A12A3R9	0698-7231	2		RESISTOR 619 1% .05W F TC=0+-100	24546	C3-1/8-TO-619R-F
A12A3R10	0757-1090	5		RESISTOR 261 1% .5W F TC=0+-100	28480	0757-1090
A12A3R11	0699-1346	0		RESISTOR 12.1 1% .125W F TC=0+-100	28480	0699-1346
A12A3R12	0699-1361	9		RESISTOR 51.1 1% .125W F TC=0+-100	28480	0699-1361
A12A3R13	0698-7205	0		RESISTOR 51.1 1% .05W F TC=0+-100	24546	C3-1/8-TO-51R1-F
A12A3R14	0698-7260	7		RESISTOR 10K 1% .05W F TC=0+-100	24546	C3-1/8-TO-1002-F
A12A3R15	0698-7188	8		RESISTOR 10 1% .05W F TC=0+-100	24546	C3-1/8-TO-10R-F
A12A3R16	0757-0399	5		RESISTOR 82.5 1% .125W F TC=0+-100	24546	C4-1/8-TO-82R5-F
A12A3R17	0757-0422	5		RESISTOR 909 1% .125W F TC=0+-100	24546	C4-1/8-TO-909R-F
A12A3R18	0698-7205	0		RESISTOR 51.1 1% .05W F TC=0+-100	24546	C3-1/8-TO-51R1-F
A12A3R19	0698-7238	9		RESISTOR 1.21K 1% .05W F TC=0+-100	24546	C3-1/8-TO-1211-F
A12A3R20	0698-7280	1		RESISTOR 68.1K 1% .05W F TC=0+-100	24546	C3-1/8-TO-6812-F
A12A3R21	0698-7238	9		RESISTOR 1.21K 1% .05W F TC=0+-100	24546	C3-1/8-TO-1211-F
A12A3R22	0698-7280	1		RESISTOR 68.1K 1% .05W F TC=0+-100	24546	C3-1/8-TO-6812-F
A12A3R23	0698-7236	7		RESISTOR 1K 1% .05W F TC=0+-100	24546	C3-1/8-TO-1001-F
A12A3R24	0757-0280	3		RESISTOR 1K 1% .125W F TC=0+-100	24546	C4-1/8-TO-1001-F
A12A3R25	0698-3400	9		RESISTOR 147 1% .5W F TC=0+-100	28480	0698-3400
A12A3R26	0698-7256	1		RESISTOR 6.81K 1% .05W F TC=0+-100	24546	C3-1/8-TO-6811-F
A12A3R27	0698-7243	6		RESISTOR 1.96K 1% .05W F TC=0+-100	24546	C3-1/8-TO-1961-F
A12A3R28	0698-7260	7		RESISTOR 10K 1% .05W F TC=0+-100	24546	C3-1/8-TO-1002-F
A12A3R29	0698-7248	1		RESISTOR 3.16K 1% .05W F TC=0+-100	24546	C3-1/8-TO-3161-F
A12A3R30	0698-7229	8		RESISTOR 511 1% .05W F TC=0+-100	24546	C3-1/8-TO-511R-F
A12A3R31				NOT ASSIGNED		
A12A3R32	2100-3090	0		RESISTOR-TRMR 500 10% C TOP-ADJ 17-TRN	32997	3292W-1-501
A12A3R33	0698-7264	1		RESISTOR 14.7K 1% .05W F TC=0+-100	24546	C3-1/8-TO-1472-F
A12A3R34	0698-8825	2		RESISTOR 681K 1% .125W F TC=0+-100	28480	0698-8825
A12A3R35	0698-8825	2		RESISTOR 681K 1% .125W F TC=0+-100	28480	0698-8825

See introduction to this section for ordering information.

\* Indicates factory selected value

Table 6-2. Replaceable Parts

Reference Designation	HP Part Number	C D	Qty	Description	Mfr Code	Mfr Part Number
A12A3R36	0757-0280	3		RESISTOR 1K 1% .125W F TC=0+-100	24546	C4-1/8-T0-1001-F
A12A3R37	0757-0280	3		RESISTOR 1K 1% .125W F TC=0+-100	24546	C4-1/8-T0-1001-F
A12A3R38	0698-7229	8		RESISTOR 511 1% .05W F TC=0+-100	24546	C3-1/8-T0-511R-F
A12A3R39	0757-0274	5		RESISTOR 1.21K 1% .125W F TC=0+-100	24546	C4-1/8-T0-1211-F
A12A3R40	0698-7284	5		RESISTOR 100K 1% .05W F TC=0+-100	24546	C3-1/8-T0-1003-F
A12A3R41	0757-0835	4		RESISTOR 6.81K 1% .5W F TC=0+-100	28480	0757-0835
A12A3R42	0757-0280	3		RESISTOR 1K 1% .125W F TC=0+-100	24546	C4-1/8-T0-1001-F
A12A3R43	0698-6364	0		RESISTOR 50 .1% .125W F TC=0+-25	28480	0698-6364
A12A3R44	0698-6323	1		RESISTOR 100 .1% .125W F TC=0+-25	28480	0698-6323
A12A3R45	0698-6377	5		RESISTOR 200 .1% .125W F TC=0+-25	28480	0698-6377
A12A3R46	0698-6355	9		RESISTOR 400 .1% .125W F TC=0+-25	28480	0698-6355
A12A3R47	0698-8028	7		RESISTOR 800 1% .125W F TC=0+-100	19701	MF4C1/8-T0-800R-F
A12A3R48	0698-6103	5		RESISTOR 1.6K .1% .125W F TC=0+-50	28480	0698-6103
A12A3R49	0698-6362	8		RESISTOR 1K .1% .125W F TC=0+-25	28480	0698-6362
A12A3R50	0698-6624	5		RESISTOR 2K .1% .125W F TC=0+-25	28480	0698-6624
A12A3R51	0698-5323	9		RESISTOR 4K .5% .125W F TC=0+-50	28480	0698-5323
A12A3R52	0698-3200	7		RESISTOR 8K 1% .125W F TC=0+-100	24546	C4-1/8-T0-8001-F
A12A3R53	0698-7884	1		RESISTOR 16K 1% .125W F TC=0+-50	19701	MF4C1/8-T2-1602-F
A12A3R54	0698-6900	0		RESISTOR 32K .5% .125W F TC=0+-50	28480	0698-6900
A12A3R55	0698-7284	5		RESISTOR 100K 1% .05W F TC=0+-100	24546	C3-1/8-T0-1003-F
A12A3R56	0698-8827	4		RESISTOR 1M 1% .125W F TC=0+-100	28480	0698-8827
A12A3R57	0698-3458	7		RESISTOR 348K 1% .125W F TC=0+-100	28480	0698-3458
A12A3R58	0698-8827	4		RESISTOR 1M 1% .125W F TC=0+-100	28480	0698-8827
A12A3R59	0698-7253	8		RESISTOR 5.11K 1% .05W F TC=0+-100	24546	C3-1/8-T0-5111-F
A12A3R60	0757-0465	6		RESISTOR 100K 1% .125W F TC=0+-100	24546	C4-1/8-T0-1003-F
A12A3R61	0757-0465	6		RESISTOR 100K 1% .125W F TC=0+-100	24546	C4-1/8-T0-1003-F
A12A3R62	0698-7205	0		RESISTOR 51.1 1% .05W F TC=0+-100	24546	C3-1/8-T0-51R1-F
A12A3R63	0698-7272	1		RESISTOR 31.6K 1% .05W F TC=0+-100	24546	C3-1/8-T0-3162-F
A12A3R64	0698-7272	1		RESISTOR 31.6K 1% .05W F TC=0+-100	24546	C3-1/8-T0-3162-F
A12A3R65	0698-7256	1		RESISTOR 6.81K 1% .05W F TC=0+-100	24546	C3-1/8-T0-6811-F
A12A3R66	0698-7256	1		RESISTOR 6.81K 1% .05W F TC=0+-100	24546	C3-1/8-T0-6811-F
A12A3R67	0698-7256	1		RESISTOR 6.81K 1% .05W F TC=0+-100	24546	C3-1/8-T0-6811-F
A12A3R68	0698-7205	0		RESISTOR 51.1 1% .05W F TC=0+-100	24546	C3-1/8-T0-51R1-F
A12A3R69	0698-7253	8		RESISTOR 5.11K 1% .05W F TC=0+-100	24546	C3-1/8-T0-5111-F
A12A3R70	0757-0280	3		RESISTOR 1K 1% .125W F TC=0+-100	24546	C4-1/8-T0-1001-F
A12A3R71	1810-0205	7	1	NETWORK-RES 8-SIP4.7K OHM X 7	01121	208A472
A12A3R72	0699-1242	5		RESISTOR 422 1% .2W C TC=0+-200	28480	0699-1242
A12A3R73	0699-1242	5		RESISTOR 422 1% .2W C TC=0+-200	28480	0699-1242
A12A3R74-R100				NOT ASSIGNED		
A12A3R101	0698-7188	8		RESISTOR 10 1% .05W F TC=0+-100	24546	C3-1/8-T0-10R-F
A12A3R102	0698-7212	9		RESISTOR 100 1% .05W F TC=0+-100	24546	C3-1/8-T0-100R-F
2427A TO 2529A A12A3R103	0698-7208	3		RESISTOR 68.1 1% .05W F TC=0+-100	24546	C3-1/8-T0-68R1-F
2530A TO 2535A A12A3R103	0698-7212	9		RESISTOR 100 1% .05W F TC=0+-100	24546	C3-1/8-T0-100R-F
2543A AND ABOVE A12A3R103	0698-7214	1		RESISTOR 121 1% .05W F TC=0+-100	24546	C3-1/8-T0-121R-F
A12A3R104	0698-7212	9		RESISTOR 100 1% .05W F TC=0+-100	24546	C3-1/8-T0-100R-F
A12A3R105				NOT ASSIGNED		
A12A3R106				NOT ASSIGNED		
A12A3R107	0698-3132	4	8	RESISTOR 261 1% .125W F TC=0+-100	24546	C4-1/8-T0-2610-F
2427A TO 2529A A12A3R108	0698-7227	6		RESISTOR 422 1% .05W F TC=0+-100	24546	C3-1/8-T0-422R-F
A12A3R109	0698-7227	6		RESISTOR 422 1% .05W F TC=0+-100	24546	C3-1/8-T0-422R-F
A12A3R110	0698-7260	7		RESISTOR 10K 1% .05W F TC=0+-100	24546	C3-1/8-T0-1002-F
2530A AND ABOVE A12A3R108	0698-3445	2		RESISTOR 348 1% .125W F TC=0+-100	24546	C4-1/8-T0-348R-F
A12A3R109	0698-3445	2		RESISTOR 348 1% .125W F TC=0+-100	24546	C4-1/8-T0-348R-F
A12A3R110	0698-7232	3		RESISTOR 681 1% .05W F TC=0+-100	24546	C3-1/8-T0-681R-F
A12A3R111				NOT ASSIGNED		
A12A3R112	0698-3132	4		RESISTOR 261 1% .125W F TC=0+-100	24546	C4-1/8-T0-2610-F
A12A3R113	0698-7222	1	5	RESISTOR 261 1% .05W F TC=0+-100	24546	C3-1/8-T0-261R-F
A12A3R114	0698-3132	4		RESISTOR 261 1% .125W F TC=0+-100	24546	C4-1/8-T0-2610-F
A12A3R115	0698-7188	8		RESISTOR 10 1% .05W F TC=0+-100	24546	C3-1/8-T0-10R-F
A12A3R116	0698-7212	9		RESISTOR 100 1% .05W F TC=0+-100	24546	C3-1/8-T0-100R-F
A12A3R117	0698-3132	4		RESISTOR 261 1% .125W F TC=0+-100	24546	C4-1/8-T0-2610-F

See introduction to this section for ordering information.

\* Indicates factory selected value

Table 6-2. Replaceable Parts

Reference Designation	HP Part Number	C D	Qty	Description	Mfr Code	Mfr Part Number
2427A TO 2529A A12A3R118	0698-7208	3		RESISTOR 68.1 1% .05W F TC=0+-100	24546	C3-1/8-TO-68R1-F
2530A TO 2535A A12A3R118	0698-7212	9		RESISTOR 100 1% .05W F TC=0+-100	24546	C3-1/8-TO-100R-F
2543A AND ABOVE A12A3R118	0698-7214	1		RESISTOR 121 1% .05W F TC=0+-100	24546	C3-1/8-TO-121R-F
A12A3R119	0698-3132	4		RESISTOR 261 1% .125W F TC=0+-100	24546	C4-1/8-TO-2610-F
A12A3R120	0698-3132	4		RESISTOR 261 1% .125W F TC=0+-100	24546	C4-1/8-TO-2610-F
A12A3R121	0698-7222	1		RESISTOR 261 1% .05W F TC=0+-100	24546	C3-1/8-TO-261R-F
A12A3R122	0698-3132	4		RESISTOR 261 1% .125W F TC=0+-100	24546	C4-1/8-TO-2610-F
A12A3R123	0698-3132	4		RESISTOR 261 1% .125W F TC=0+-100	24546	C4-1/8-TO-2610-F
A12A3R124	0698-3447	4		RESISTOR 422 1% .125W F TC=0+-100	24546	C4-1/8-TO-422R-F
A12A3R125	0757-0394	0		RESISTOR 51.1 1% .125W F TC=0+-100	24546	C4-1/8-TO-51R1-F
2427A TO 2529A A12A3R126	0698-7229	8		RESISTOR 511 1% .05W F TC=0+-100	24546	C3-1/8-TO-511R-F
A12A3R127	0698-7229	8		RESISTOR 511 1% .05W F TC=0+-100	24546	C3-1/8-TO-511R-F
A12A3R128	0698-7221	0	3	RESISTOR 237 1% .05W F TC=0+-100	24546	C3-1/8-TO-237R-F
2530A AND ABOVE A12A3R126-R128				NOT ASSIGNED		
A12A3R129	0698-7205	0		RESISTOR 51.1 1% .05W F TC=0+-100	24546	C3-1/8-TO-51R1-F
A12A3R130	0698-7236	7		RESISTOR 1K 1% .05W F TC=0+-100	24546	C3-1/8-TO-1001-F
2427A TO 2529A A12A3R131	0698-7222	1		RESISTOR 261 1% .05W F TC=0+-100	24546	C3-1/8-TO-261R-F
A12A3R132	0698-7229	8		RESISTOR 511 1% .05W F TC=0+-100	24546	C3-1/8-TO-511R-F
A12A3R133	0698-7229	8		RESISTOR 511 1% .05W F TC=0+-100	24546	C3-1/8-TO-511R-F
A12A3R134	0698-7229	8		RESISTOR 511 1% .05W F TC=0+-100	24546	C3-1/8-TO-511R-F
2530A AND ABOVE A12A3R131				NOT ASSIGNED		
A12A3R132	0699-1424	5		RESISTOR 237 1% .125W C TC=0+-125	28480	0699-1424
A12A3R133	0699-1424	5		RESISTOR 237 1% .125W C TC=0+-125	28480	0699-1424
A12A3R134	0699-1424	5		RESISTOR 237 1% .125W C TC=0+-125	28480	0699-1424
A12A3R135	0698-7243	6		RESISTOR 1.96K 1% .05W F TC=0+-100	24546	C3-1/8-TO-1961-F
A12A3R136	0698-7243	6		RESISTOR 1.96K 1% .05W F TC=0+-100	24546	C3-1/8-TO-1961-F
A12A3R137	0698-7236	7		RESISTOR 1K 1% .05W F TC=0+-100	24546	C3-1/8-TO-1001-F
2427A TO 2529A A12A3R138	0698-7230	1		RESISTOR 562 1% .05W F TC=0+-100	24546	C3-1/8-TO-562R-F
2530A AND ABOVE A12A3R138	0698-7226	5		RESISTOR 383 1% .05W F TC=0+-100	24546	C4-1/8-TO-383R-F
A12A3R139	0698-7205	0		RESISTOR 51.1 1% .05W F TC=0+-100	24546	C3-1/8-TO-51R1-F
2427A TO 2529A A12A3R140	0698-7205	0		RESISTOR 51.1 1% .05W F TC=0+-100	24546	C3-1/8-TO-51R1-F
A12A3R141	0698-7205	0		RESISTOR 51.1 1% .05W F TC=0+-100	24546	C3-1/8-TO-51R1-F
2530A TO 2535A A12A3R140	0699-1346	0		RESISTOR 12.1 1% .125W F TC=0+-100	28480	0699-1346
A12A3R141	0699-1346	0		RESISTOR 12.1 1% .125W F TC=0+-100	28480	0699-1346
2543A AND ABOVE A12A3R140	0699-1359	5		RESISTOR 42.2 1% .125W F TC=0+-100	28480	0699-1359
A12A3R141	0699-1359	5		RESISTOR 42.2 1% .125W F TC=0+-100	28480	0699-1359
2427A TO 2529A A12A3R142	0698-7208	3		RESISTOR 68.1 1% .05W F TC=0+-100	24546	C3-1/8-TO-68R1-F
A12A3R143	0698-7220	9		RESISTOR 215 1% .05W F TC=0+-100	24546	C3-1/8-TO-215R-F
2530A AND ABOVE A12A3R142	0699-1827	2		RESISTOR 130 1% .2W C TC=0+-200	28480	0699-1827
A12A3R143	0699-1430	3		RESISTOR 422 1% .125W F TC=0+-100	28480	0699-1430
A12A3R144	0698-7243	6		RESISTOR 1.96K 1% .05W F TC=0+-100	24546	C3-1/8-TO-1961-F
A12A3R145	0698-7205	0		RESISTOR 51.1 1% .05W F TC=0+-100	24546	C3-1/8-TO-51R1-F

See introduction to this section for ordering information.

\* Indicates factory selected value

Table 6-2. Replaceable Parts

Reference Designation	HP Part Number	C D	Qty	Description	Mfr Code	Mfr Part Number
2427A TO 2529A						
A12A3R146	0698-7199	1	2	RESISTOR 28.7 1% .05W F TC=0+-100	24546	C3-1/8-T0-28R7-F
A12A3R147	0698-7199	1		RESISTOR 28.7 1% .05W F TC=0+-100	24546	C3-1/8-T0-28R7-F
2530A AND ABOVE						
A12A3R146	0699-0938	4		RESISTOR 26.1 1% .05W F TC=0+-100	28480	0699-0938
2530A TO 2535A						
A12A3R147	0699-0938	4		RESISTOR 26.1 1% .05W F TC=0+-100	28480	0699-0938
2543A AND ABOVE						
A12A3R147*	0699-1947	7		RESISTOR 38.3 1% .05W F TC=0+-100	28480	0699-1947
2427A TO 2529A						
A12A3R148-R170				NOT ASSIGNED		
2530A AND ABOVE						
A12A3R148	0699-1435	8		RESISTOR 681 1% .125W F TC=0+-100	28480	0699-1435
2530A TO 2535A						
A12A3R149	0699-1430	3		RESISTOR 422 1% .125W F TC=0+-100	28480	0699-1430
A12A3R150	0699-1827	2		RESISTOR 130 1% .2W C TC=0+-200	28480	0699-1827
2543A AND ABOVE						
A12A3R149				NOT ASSIGNED		
A12A3R150				NOT ASSIGNED		
2530A AND ABOVE						
A12A3R151	0699-1435	8		RESISTOR 681 1% .125W F TC=0+-100	28480	0699-1435
A12A3R152	0699-1435	8		RESISTOR 681 1% .125W F TC=0+-100	28480	0699-1435
2530A TO 2535A						
A12A3R153	0699-1430	3		RESISTOR 422 1% .125W F TC=0+-100	28480	0699-1430
A12A3R154	0699-1827	2		RESISTOR 130 1% .2W C TC=0+-200	28480	0699-1827
2543A AND ABOVE						
A12A3R153				NOT ASSIGNED		
A12A3R154				NOT ASSIGNED		
2530A AND ABOVE						
A12A3R155	0699-1429	0		RESISTOR 383 1% .125W F TC=0+-100	28480	0699-1429
A12A3R156	0699-1429	0		RESISTOR 383 1% .125W F TC=0+-100	28480	0699-1429
A12A3R157	0699-1429	0		RESISTOR 383 1% .125W F TC=0+-100	28480	0699-1429
A12A3R158-R160				NOT ASSIGNED		
A12A3R161	0699-1498	3		RESISTOR 237 1% .125W C TC=0+-125	28480	0699-1498
A12A3R162	0699-1498	3		RESISTOR 237 1% .125W C TC=0+-125	28480	0699-1498
A12A3R163	0699-1498	3		RESISTOR 237 1% .125W C TC=0+-125	28480	0699-1498
A12A3R164	0699-1424	5		RESISTOR 237 1% .125W C TC=0+-125	28480	0699-1424
A12A3R165	0699-1424	5		RESISTOR 237 1% .125W C TC=0+-125	28480	0699-1424
A12A3R166	0699-1424	5		RESISTOR 237 1% .125W C TC=0+-125	28480	0699-1424
2427A TO 2535A						
A12A3R167-R170				NOT ASSIGNED		
2543A AND ABOVE						
A12A3R167	0699-1359	5		RESISTOR 42.2 1% .125W F TC=0+-100	28480	0699-1359
A12A3R168	0699-1503	1		RESISTOR-ZERO OHMS SMD ZERO OHM JUMPER	28480	0699-1503
A12A3R169	0699-1503	1		RESISTOR-ZERO OHMS SMD ZERO OHM JUMPER	28480	0699-1503
A12A3R170	0699-1503	1		RESISTOR-ZERO OHMS SMD ZERO OHM JUMPER	28480	0699-1503
A12A3S1	3101-2566	6		SWITCH-RKR DIP-RKR-ASSY DPDT .5A 30VDC	28480	3101-2566
A12A3T1	9100-4365	1		TRANSFORMER-RF INPUT Z:50 OHMS;Z RATIO:1	28480	9100-4365
A12A3T2	9100-4365	1		TRANSFORMER-RF INPUT Z:50 OHMS;Z RATIO:1	28480	9100-4365
A12A3TP1	0360-0535	0		TERMINAL TEST POINT PCB	00000	ORDER BY DESCRIPTION
A12A3TP2	1252-0216	6		CONNECTOR-SGL CONT SKT .04-IN-BSC-SZ RND	28480	1252-0216
A12A3TP3	1250-0835	1		CONNECTOR-RF SMC M PC 50-OHM	28480	1250-0835
A12A3TP4	0360-0535	0		TERMINAL TEST POINT PCB	00000	ORDER BY DESCRIPTION
A12A3U1	1820-0668	7		IC BFR TTL NON-INV HEX 1-INP	01295	SN7407N
A12A3U2	1820-1858	9		IC FF TTL LS D-TYPE OCTL	01295	SN74LS377N
A12A3U3	1820-0668	7		IC BFR TTL NON-INV HEX 1-INP	01295	SN7407N
A12A3U4	1820-0668	7		IC BFR TTL NON-INV HEX 1-INP	01295	SN7407N
A12A3U5	1820-1858	9		IC FF TTL LS D-TYPE OCTL	01295	SN74LS377N
A12A3U6	1820-1433	6		IC SHF-RGTR TTL LS R-S SERIAL-IN PRL-OUT	01295	SN74LS164N
A12A3U7	1820-1416	5		IC SCHMITT-TRIG TTL LS INV HEX 1-INP	01295	SN74LS14N
A12A3U8	1820-1433	6		IC SHF-RGTR TTL LS R-S SERIAL-IN PRL-OUT	01295	SN74LS164N
A12A3U9	1820-1433	6		IC SHF-RGTR TTL LS R-S SERIAL-IN PRL-OUT	01295	SN74LS164N
A12A3U10	1826-0605	4		IC MULTIPLXR 8-CHAN-ANLG 16-DIP-C PKG	17856	DG508BK

See introduction to this section for ordering information.

\* Indicates factory selected value

Table 6-2. Replaceable Parts

Reference Designation	HP Part Number	C D	Qty	Description	Mfr Code	Mfr Part Number
A12A3U11	1820-1212	9		IC FF TTL LS J-K NEG-EDGE-TRIG	01295	SN74LS112AN
A12A3U12	1826-0783	9		IC OP AMP LOW-NOISE 8-DIP-C PKG	52063	XR5534ACN
A12A3U13				NOT ASSIGNED		
A12A3U14	1826-0785	1		IC OP AMP LOW-BIAS-H-IMPED DUAL 8-DIP-C	01295	TL072ACJG
A12A3U15	1820-1858	9		IC FF TTL LS D-TYPE OCTL	01295	SN74LS377N
A12A3U16	1826-0606	5		IC SWITCH ANLG QUAD 16-DIP-C PKG	17856	DG201BK
A12A3U17	1820-1437	0		IC MV TTL LS MONOSTBL DUAL	01295	SN74LS221N
<b>2427A TO 2738A</b> A12A3U18	1826-0759	9		IC COMPARATOR GP QUAD 14-DIP-C PKG	04713	LM399J
<b>2809A AND ABOVE</b> A12A3U18	1826-0138	8		IC COMPARATOR GP QUAD 14-DIP-C PKG	01295	LM339N
A12A3U19	1826-0180	0		IC TIMER TTL MONO/ASTBL	01295	NE555P
A12A3U20-U100				NOT ASSIGNED		
A12A3U101	1826-0372	2		IC MISC 8-DIP-P PKG	28480	1826-0372
A12A3U102	1826-0372	2		IC MISC 8-DIP-P PKG	28480	1826-0372
A12A3U103	1820-0471	0	1	IC INV TTL HEX 1-INP	01295	SN7406N
A12A3U104	1820-1216	3		IC DCDR TTL LS 3-TO-8-LINE 3-INP	01295	SN74LS138N
A12A3U105	1820-1202	7	1	IC GATE TTL LS NAND TPL 3-INP	01295	SN74LS10N
A12A3U106	1820-2933	3	1	IC PRESCR ECL	28480	1820-2933
A12A3U107	1820-0796	2	1	IC GATE ECL NOR QUAD 2-INP	04713	MC1662L
A12A3U108	1820-1173	1	2	IC XLTR ECL TTL-TO-ECL QUAD 2-INP	04713	MC10124L
<b>2427A TO 2529A</b> A12A3U109	1820-1173	1		IC XLTR ECL TTL-TO-ECL QUAD 2-INP	04713	MC10124L
<b>2530A AND ABOVE</b> A12A3U109	1820-0471	0		IC INV TTL HEX 1-INP	01295	SN7406N
A12A3U110	1820-2634	1		IC INV TTL ALS HEX	01295	SN74ALS04N
A12A3U111	1820-2657	8		IC GATE TTL ALS OR QUAD 2-INP	01295	SN74ALS32N
A12A3U112	1820-0682	5	1	IC GATE TTL S NAND QUAD 2-INP	01295	SN74S03N
A12A3U113	1820-3485	2		IC PRESCR ECL	04713	MC12090
A12A3U114	1820-3485	2		IC PRESCR ECL	04713	MC12090
A12A3U115	1820-3485	2		IC PRESCR ECL	04713	MC12090
A12A3U116	1820-1052	5		IC XLTR ECL ECL-TO-TTL QUAD 2-INP	04713	MC10125L
A12A3U117	1820-2691	0		IC FF TTL F D-TYPE POS-EDGE-TRIG	07263	74F74PC
A12A3U118	1820-2691	0		IC FF TTL F D-TYPE POS-EDGE-TRIG	07263	74F74PC
A12A3VR1	1902-1428	3		DIODE-ZNR 4.6V DO-35 PD=.4W IR=1UA	28480	1902-1428
A12A3VR2	1902-1428	3		DIODE-ZNR 4.6V DO-35 PD=.4W IR=1UA	28480	1902-1428
A12A3VR3	1902-0680	7		DIODE-ZNR 1N827 6.2V 5% DO-7 PD=.4W	24046	1N827
A12A3VR4-VR100				NOT ASSIGNED		
A12A3VR101	1902-0953	7	2	DIODE-ZNR 6.2V 5% DO-35 PD=.4W TC=+.053%	28480	1902-0953
<b>2427A TO 2529A</b> A12A3VR102-VR104				NOT ASSIGNED		
<b>2530A AND ABOVE</b> A12A3VR102	1902-0953	7	2	DIODE-ZNR 6.2V 5% DO-35 PD=.4W TC=+.053%	28480	1902-0953
A12A3VR103	1902-0953	7	2	DIODE-ZNR 6.2V 5% DO-35 PD=.4W TC=+.053%	28480	1902-0953
A12A3VR104	1902-0953	7	2	DIODE-ZNR 6.2V 5% DO-35 PD=.4W TC=+.053%	28480	1902-0953
A12A3W1-W100				NOT ASSIGNED		
<b>2427A TO 2529A</b> A12A3W101	8159-0005	0		RESISTOR-ZERO OHMS 22 AWG LEAD DIA	28480	8159-0005
<b>2530A AND ABOVE</b> A12A3W101				NOT ASSIGNED		
A12A3Z1	0955-0219	8		MIXER-DOUBLE BALANCED RF: .5-500MHZ; IF	28480	0955-0219
	1251-3172	7		CONNECTOR-SGL CONT SKT .03-IN-BSC-SZ RND	28480	1251-3172

See introduction to this section for ordering information.

\* Indicates factory selected value



Table 6-2. Replaceable Parts

Reference Designation	HP Part Number	C D	Qty	Description	Mfr Code	Mfr Part Number
<b>A13</b>						
A13	08642-60898	8	1	OUTPUT FILTERS/ALC MODULE	28480	08642-60898
A13	08642-69898	6	1	OUTPUT FILTERS/ALC MODULE (RESTORED)	28480	08642-69898
A13FL1	08642-80047	1	1	FLTR LP 7POS BKT	28480	08642-80047
A13MP1	08642-20017	9	1	COVER LOW PASS FILTER	28480	08642-20017
A13MP2	08642-20029	3	3	HEATSINK XSTOR	28480	08642-20029
A13MP3	08642-20016	8	1	BASE OUTPUT UHF	28480	08642-20016
A13MP4	08642-00001	9	1	GASKET 7 P FILTR	28480	08642-00001
A13MP5	0515-1521	5	1	SCREW-MACH M3 X 0.5 5MM-LG 90-DEG-FLH-HD (ATTACH FILTER TO BASE)	28480	0515-1521
A13MP6	08642-20015	7	1	COVER OUTUHF ALC/POWER AMPLIFIER	28480	08642-20015
A13MP7	08642-40058	0	1	GASKET FEEDTHRU	28480	08642-40058
A13MP8	08642-00049	5	1	SLIDE-MDL469R56 (FRONT AND REAR)	28480	08642-00049
A13MP9	0515-1102	8	1	SCREW-MACH M3 X 0.5 8MM-LG 90-DEG-FLH-HD (ATTACH MODULE SLIDES TO BASE)	28480	0515-1102
A13MP10	0515-0684	9	1	SCREW-MACH M4 X 0.7 6MM-LG PAN-HD (ATTACH BOARDS TO BASE)	28480	0515-0684
A13MP11	0515-1101	7	2	SCREW-MACH M4 X 0.7 8MM-LG 90-DEG-FLH-HD (ATTACH A13A2 TO BASE)	28480	0515-1101
A13MP12	0515-0381	3	1	SCREW-MACH M4 X 0.7 10MM-LG PAN-HD (ATTACH COVERS TO BASE)	00000	ORDER BY DESCRIPTION
A13MP12	8160-0472	8	1	RFI ROUND STRIP BE-CU SN-PL .093-IN-OD (SPIRA SHIELD)	28480	8160-0472
A13MP13	08642-80069	7	1	LABEL-UHF 60006	28480	08642-80069
A13W1	5061-4807	8	1	CBL-COAX 926 (A13A1J1 TO A13A2J5)	28480	5061-4807
A13W2	5061-4808	9	1	CBL-COAX 924 (A13A1J2 TO A13A2J2)	28480	5061-4808

See introduction to this section for ordering information.

\* Indicates factory selected value



Table 6-2. Replaceable Parts

Reference Designation	HP Part Number	C D	Qty	Description	Mfr Code	Mfr Part Number
<b>A13A1</b>						
2427A TO 2510A A13A1	08642-60112	9	1	LOW PASS FILTER ASSEMBLY	28480	08642-60112
2511A TO 2550A A13A1	08642-60212	0	1	LOW PASS FILTER ASSEMBLY	28480	08642-60212
2551A AND ABOVE A13A1	08642-60312	1	1	LOW PASS FILTER ASSEMBLY	28480	08642-60212
A13A1C1	0121-0448	8	5	CAPACITOR-V TRMR-CER 2.5-5PF 63V PC-MTG	28480	0121-0448
A13A1C2	0121-0448	8		CAPACITOR-V TRMR-CER 2.5-5PF 63V PC-MTG	28480	0121-0448
A13A1C3	0121-0448	8		CAPACITOR-V TRMR-CER 2.5-5PF 63V PC-MTG	28480	0121-0448
2427A TO 2550A A13A1C4	0121-0448	8		CAPACITOR-V TRMR-CER 2.5-5PF 63V PC-MTG	28480	0121-0448
A13A1C5	0121-0448	8		CAPACITOR-V TRMR-CER 2.5-5PF 63V PC-MTG	28480	0121-0448
2551A AND ABOVE A13A1C4	0121-0565	0		CAPACITOR-V TRMR-CER 2.5-5PF 63V PC MTG	28480	0121-0565
A13A1C5	0121-0565	0		CAPACITOR-V TRMR-CER 2.5-5PF 63V PC MTG	28480	0121-0565
A13A1C6				NOT ASSIGNED		
A13A1C7	0160-6709	8		CAPACITOR-FXD 10PF 200VDC CER	28480	0160-6709
A13A1C8	0160-6706	5		CAPACITOR-FXD 13PF 200VDC CER	28480	0160-6706
A13A1C9	0160-6709	8		CAPACITOR-FXD 10PF 200VDC CER	28480	0160-6709
A13A1C10	0160-6707	6		CAPACITOR-FXD 12PF 200VDC CER	28480	0160-6707
A13A1C11	0160-6708	7		CAPACITOR-FXD 18PF 200VDC CER	28480	0160-6708
A13A1C12	0160-6707	6		CAPACITOR-FXD 12PF 200VDC CER	28480	0160-6707
A13A1C13	0160-4767	4		CAPACITOR-FXD 20PF +-5% 200VDC CER 0+-30	28480	0160-4767
2427A TO 2550A A13A1C14	0160-4493	3		CAPACITOR-FXD 27PF +-5% 200VDC CER 0+-30	28480	0160-4493
2551A AND ABOVE A13A1C14	0160-4524	1		CAPACITOR-FXD 24PF+-5% 200VDC CER 0+-30	51642	200-200-NPO-240J
A13A1C15	0160-4767	4		CAPACITOR-FXD 20PF +-5% 200VDC CER 0+-30	28480	0160-4767
A13A1C16	0160-4766	3		CAPACITOR-FXD 30PF +-5% 200VDC CER 0+-30	28480	0160-4766
A13A1C17	0160-4526	3		CAPACITOR-FXD 42PF +-5% 200VDC CER 0+-30	28480	0160-4526
A13A1C18	0160-4766	3		CAPACITOR-FXD 30PF +-5% 200VDC CER 0+-30	28480	0160-4766
A13A1C19	0160-4526	3		CAPACITOR-FXD 42PF +-5% 200VDC CER 0+-30	28480	0160-4526
A13A1C20	0160-4527	4		CAPACITOR-FXD 56PF +-5% 200VDC CER 0+-30	28480	0160-4527
A13A1C21	0160-4526	3		CAPACITOR-FXD 42PF +-5% 200VDC CER 0+-30	28480	0160-4526
A13A1C22	0160-4527	4		CAPACITOR-FXD 56PF +-5% 200VDC CER 0+-30	28480	0160-4527
A13A1C23	0160-5939	4		CAPACITOR-FXD 100PF +-5PF 100VDC CER	28480	0160-5939
A13A1C24	0160-4527	4		CAPACITOR-FXD 56PF +-5% 200VDC CER 0+-30	28480	0160-4527
2427A TO 2534A A13A1C25	0160-4350	1	2	CAPACITOR-FXD 68PF +-5% 200VDC CER 0+-30	28480	0160-4350
2535A AND ABOVE A13A1C25	0160-4387	4		CAPACITOR-FXD 47PF +-5% 200VDC CER 0+-30	28480	0160-4387
2427A TO 2510A A13A1C26	0160-4926	7	3	CAPACITOR-FXD 110PF +-5% 200VDC CER	28480	0160-4926
2511A TO 2534A A13A1C26	0160-4512	7	3	CAPACITOR-FXD 120PF +-5% 200VDC CER	28480	0160-4512
2535A AND ABOVE A13A1C26	0160-4389	6		CAPACITOR-FXD 100PF +-5PF 200VDC CER	28480	0160-4389
2427A TO 2534A A13A1C27	0160-4350	1		CAPACITOR-FXD 68PF +-5% 200VDC CER 0+-30	28480	0160-4350
A13A1C28	0160-4389	6		CAPACITOR-FXD 100PF +-5PF 200VDC CER	28480	0160-4389
2535A AND ABOVE A13A1C27	0160-4387	4		CAPACITOR-FXD 47PF +-5% 200VDC CER 0+-30	28480	0160-4387
A13A1C28	0160-4497	7		CAPACITOR-FXD 82 F +-5% 200VDC CER 0+-30	28480	0160-4497
A13A1C29	0160-5413	9	1	CAPACITOR-FXD 160PF +-5% 100VDC CER	28480	0160-5413
2427A TO 2534A A13A1C30	0160-4389	6		CAPACITOR-FXD 100PF +-5PF 200VDC CER	28480	0160-4389
2535A AND ABOVE A13A1C30	0160-4497	7		CAPACITOR-FXD 82 F +-5% 200VDC CER 0+-30	28480	0160-4497
A13A1C31	0160-4926	7		CAPACITOR-FXD 110PF +-5% 200VDC CER	28480	0160-4926
A13A1C32	0160-4617	3		CAPACITOR-FXD 180PF +-5% 200VDC CER	28480	0160-4617
A13A1C33	0160-4617	3		CAPACITOR-FXD 180PF +-5% 200VDC CER	28480	0160-4617
A13A1C34	0160-4926	7		CAPACITOR-FXD 110PF +-5% 200VDC CER	28480	0160-4926
A13A1C35	0160-4547	8		CAPACITOR-FXD 150PF +-5% 200VDC CER	28480	0160-4547
A13A1C36	0160-4588	7		CAPACITOR-FXD 270PF +-5% 100VDC CER	28480	0160-4588
A13A1C37	0160-4588	7		CAPACITOR-FXD 270PF +-5% 100VDC CER	28480	0160-4588
A13A1C38	0160-4547	8		CAPACITOR-FXD 150PF +-5% 200VDC CER	28480	0160-4547
A13A1C39	0160-4511	5		CAPACITOR-FXD 220PF +-5% 200VDC CER	28480	0160-4511
A13A1C40	0160-4502	5		CAPACITOR-FXD 390PF +-5% 100VDC CER	28480	0160-4502

See introduction to this section for ordering information.

\* Indicates factory selected value

Table 6-2. Replaceable Parts

Reference Designation	HP Part Number	C D	Qty	Description	Mfr Code	Mfr Part Number
A13A1C41	0160-4502	5	2	CAPACITOR-FXD 380PF +-5% 100VDC CER	28480	0160-4502
A13A1C42	0160-4511	6		CAPACITOR-FXD 220PF +-5% 200VDC CER	28480	0160-4511
A13A1C43	0160-4031	5		CAPACITOR-FXD 330PF +-5% 100VDC CER	28480	0160-4031
A13A1C44	0160-4616	2		CAPACITOR-FXD 560PF +-5% 200VDC CER	28480	0160-4616
A13A1C45	0160-4616	2		CAPACITOR-FXD 560PF +-5% 200VDC CER	28480	0160-4616
A13A1C46	0160-4031	5	2	CAPACITOR-FXD 330PF +-5% 100VDC CER	28480	0160-4031
A13A1C47	0160-4768	5		CAPACITOR-FXD 470PF +-5% 100VDC CER	28480	0160-4768
A13A1C48	0160-4030	4		CAPACITOR-FXD 820PF +-5% 100VDC CER	28480	0160-4030
A13A1C49	0160-4040	6		CAPACITOR-FXD 1000PF +-5% 100VDC CER	28480	0160-4040
A13A1C50	0160-4040	6		CAPACITOR-FXD 1000PF +-5% 100VDC CER	28480	0160-4040
A13A1C51	0160-4040	6		CAPACITOR-FXD 1000PF +-5% 100VDC CER	28480	0160-4040
A13A1C52	0160-4040	6		CAPACITOR-FXD 1000PF +-5% 100VDC CER	28480	0160-4040
A13A1C53	0160-3879	7		CAPACITOR-FXD .01UF +-20% 100VDC CER	28480	0160-3879
A13A1C54	0160-3879	7		CAPACITOR-FXD .01UF +-20% 100VDC CER	28480	0160-3879
A13A1C55	0160-3879	7		CAPACITOR-FXD .01UF +-20% 100VDC CER	28480	0160-3879
A13A1C56	0160-3879	7		CAPACITOR-FXD .01UF +-20% 100VDC CER	28480	0160-3879
A13A1C57	0160-0576	5		CAPACITOR-FXD .1UF +-20% 50VDC CER	28480	0160-0576
A13A1C58	0160-0576	5		CAPACITOR-FXD .1UF +-20% 50VDC CER	28480	0160-0576
A13A1C59	0160-0576	5		CAPACITOR-FXD .1UF +-20% 50VDC CER	28480	0160-0576
A13A1C60	0160-0576	5		CAPACITOR-FXD .1UF +-20% 50VDC CER	28480	0160-0576
A13A1C61	0160-0576	5		CAPACITOR-FXD .1UF +-20% 50VDC CER	28480	0160-0576
A13A1C62	0160-0576	5		CAPACITOR-FXD .1UF +-20% 50VDC CER	28480	0160-0576
A13A1C63	0160-0576	5		CAPACITOR-FXD .1UF +-20% 50VDC CER	28480	0160-0576
A13A1C64	0160-0576	5		CAPACITOR-FXD .1UF +-20% 50VDC CER	28480	0160-0576
A13A1C65	0160-3879	7		CAPACITOR-FXD .01UF +-20% 100VDC CER	28480	0160-3879
A13A1C66	0160-0576	5		28480	0160-0576	
2427A TO 2510A A13A1C67	0160-4077	9		51959	0805X103K2P	
2511A AND ABOVE A13A1C67	0160-5945	2		28480	0160-5945	
A13A1C68	0160-0576	5		28480	0160-0576	
2427A TO 2510A A13A1C69	0160-4077	9		51959	0805X103K2P	
2511A AND ABOVE A13A1C69	0160-5945	2		28480	0160-5945	
A13A1C70	0160-0576	5		28480	0160-0576	
A13A1C71	0160-3879	7		CAPACITOR-FXD .01UF +-20% 100VDC CER	28480	0160-3879
A13A1C72	0160-0576	5		CAPACITOR-FXD .1UF +-20% 50VDC CER	28480	0160-0576
2427A TO 2510A A13A1C73	0160-4106	5		51959	1209X104M2P	
2511A AND ABOVE A13A1C73	0160-6222	0		28480	0160-6222	
2427A TO 2511A A13A1C74	0160-0576	5		28480	0160-0576	
2512A AND ABOVE A13A1C74	0160-4040	6		28480	0160-4040	
2427A TO 2510A A13A1C75	0160-5978	1		CAPACITOR-FXD 2.2PF 50VDC CER	28480	0160-5978
A13A1C76	0160-0576	5		CAPACITOR-FXD .1UF +-20% 50VDC CER	28480	0160-0576
2511A AND ABOVE A13A1C75	0160-5969	0		CAPACITOR-FXD 3.3PF +.5PF 50VDC CER	28480	0160-5969
A13A1C76	0160-5945	2		CAPACITOR-FXD .01UF +-10% 50VDC CER	28480	0160-5945
A13A1C77	0160-3879	7		28480	0160-3879	
2427A TO 2510A A13A1C78	0160-4106	5		51959	1209X104M2P	
2511A AND ABOVE A13A1C78	0160-6222	0		28480	0160-6222	
A13A1C79	0160-0576	5		CAPACITOR-FXD .1UF +-20% 50VDC CER	28480	0160-0576
A13A1C80	0160-0576	5		CAPACITOR-FXD .1UF +-20% 50VDC CER	28480	0160-0576
A13A1C81	0160-0576	5	3	CAPACITOR-FXD .1UF +-20% 50VDC CER	28480	0160-0576
A13A1C82	0160-4030	4		CAPACITOR-FXD 820PF +-5% 100VDC CER	28480	0160-4030
A13A1C83	0160-4768	5		CAPACITOR-FXD 470PF +-5% 100VDC CER	28480	0160-4768
A13A1C84	0160-4371	6		CAPACITOR-FXD 680PF +-5% 100VDC CER	28480	0160-4371

See introduction to this section for ordering information.

\* Indicates factory selected value

Table 6-2. Replaceable Parts

Reference Designation	HP Part Number	C D	Qty	Description	Mfr Code	Mfr Part Number
2427A TO 2510A A13A1C85 A13A1C86	0160-4040 0160-4040	6 6		CAPACITOR-FXD 1000PF +-5% 100VDC CER CAPACITOR-FXD 1000PF +-5% 100VDC CER	28480 28480	0160-4040 0160-4040
2511A AND ABOVE A13A1C85 A13A1C86	0160-6308 0160-6308	3 3		CAPACITOR-FXD 1100PF +-5% 100VDC CER CAPACITOR-FXD 1100PF +-5% 100VDC CER	28480 28480	0160-6308 0160-6308
A13A1C87 A13A1C88 A13A1C89 A13A1C90	0160-4371 0160-0576 0160-0576	6 5 5		CAPACITOR-FXD 680PF +-5% 100VDC CER NOT ASSIGNED CAPACITOR-FXD .1UF +-20% 50VDC CER CAPACITOR-FXD .1UF +-20% 50VDC CER	28480 28480 28480	0160-4371 0160-0576 0160-0576
2427A TO 2510A A13A1C91	0160-4106	5		CAPACITOR-FXD .1UF +-20% 50VDC CER	51959	1209X104M2P
2511A AND ABOVE A13A1C91 A13A1C91	0160-6222 0160-4106	0 5		CAPACITOR-FXD .1UF +-10% 50VDC CER CAPACITOR-FXD .1UF +-20% 50VDC CER	28480 51959	0160-6222 1209X104M2P
2427A TO 2722A A13A1C92 A13A1C93	0160-4518 0160-3872	3 0		CAPACITOR-FXD 3.9PF +- .5PF 200VDC CER CAPACITOR-FXD 2.2PF +- .25PF 200VDC CER	28480 28480	0160-4518 0160-3872
2728A AND ABOVE A13A1C92 A13A1C93	0160-5973 0160-5975	6 8		CAPACITOR-FXD 6.0PF +-5% 50VDC CER CAPACITOR-FXD 10PF +-5% 50VDC CER 0+-30	28480 28480	0160-5973 0160-5975
A13A1C94				NOT ASSIGNED		
2427A TO 2510A A13A1C95 A13A1C96	0160-5049	7	2	CAPACITOR-FXD 3.3PF +- .25PF 100VDC CER NOT ASSIGNED	28480	0160-5049
2511A TO 2533A A13A1C95 A13A1C96	0160-5969 0160-0572	0 1	3 3	CAPACITOR-FXD 3.3PF +- .5PF 50VDC CER CAPACITOR-FXD 2200PF +-20% 100VDC CER	28480 28480	0160-5969 0160-0572
2534A AND ABOVE A13A1C95 A13A1C96	0160-5969	0	3	CAPACITOR-FXD 3.3PF +- .5PF 50VDC CER NOT ASSIGNED	28480	0160-5969
2427A TO 2511A A13A1C97				NOT ASSIGNED		
2512A TO 2550A A13A1C97	0160-5942	9		CAPACITOR-FXD 1PF +-5% 50VDC CER 0+-30	28480	0160-5942
2551A AND ABOVE A13A1C97	0160-4389	6		CAPACITOR-FXD 100PF +-5PF 200VDC CER	28480	0160-4389
2427A TO 2527A A13A1C98-C101 2529A TO 2550A A13A1C98 A13A1C99 A13A1C100 A13A1C101	0160-5954 0160-5954	3 3		NOT ASSIGNED NOT ASSIGNED CAPACITOR-FXD 220PF +-5% 50VDC CER 0+-30 CAPACITOR-FXD 220PF +-5% 50VDC CER 0+-30	28480 28480	0160-5954 0160-5954
2551A TO 2722A A13A1C98	0160-5969	0		CAPACITOR-FXD 3.3PF +- .5PF 50VDC CER	28480	0160-5969
2728A AND ABOVE A13A1C98				NOT ASSIGNED		
2551A AND ABOVE A13A1C99 A13A1C100 A13A1C101	0160-4030 0160-5954 0160-5954	4 3 3		CAPACITOR-FXD 820PF +-5% 100VDC CER CAPACITOR-FXD 220PF +-5% 50VDC CER 0+-30 CAPACITOR-FXD 220PF +-5% 50VDC CER 0+-30	28480 28480 28480	0160-4030 0160-5954 0160-5954
2427A TO 2722A A13A1CR1 A13A1CR2	1901-1096 1901-1096	9 9		DIODE-PIN DIODE-PIN	28480 28480	1901-1096 1901-1096
2728A AND ABOVE A13A1CR1 A13A1CR2	1901-0639 1901-0639	4 4		DIODE-PIN DIODE-PIN	28480 28480	1901-0639 1901-0639
A13A1CR3	1901-0639	4		DIODE-PIN	28480	5082-3080
2427A TO 2722A A13A1CR4 A13A1CR5	1901-1096 1901-1096	9 9		DIODE-PIN DIODE-PIN	28480 28480	1901-1096 1901-1096
2728A AND ABOVE A13A1CR4 A13A1CR5	1901-0639 1901-0639	4 4		DIODE-PIN DIODE-PIN	28480 28480	5082-3080 5082-3080
A13A1CR6	1901-0639	4		DIODE-PIN	28480	5082-3080
2427A TO 2722A A13A1CR7 A13A1CR8	1901-1096 1901-1096	9 9		DIODE-PIN DIODE-PIN	28480 28480	1901-1096 1901-1096
2728A AND ABOVE A13A1CR7 A13A1CR8	1901-0639 1901-0639	4 4		DIODE-PIN DIODE-PIN	28480 28480	1901-0639 1901-0639
A13A1CR9 A13A1CR10	1901-0639 1901-0639	4 4		DIODE-PIN DIODE-PIN	28480 28480	5082-3080 5082-3080

See introduction to this section for ordering information.

\* Indicates factory selected value

Table 6-2. Replaceable Parts

Reference Designation	HP Part Number	C D	Qty	Description	Mfr Code	Mfr Part Number
A13A1CR11	1901-0639	4		DIODE-PIN	28480	5082-3080
A13A1CR12	1901-0639	4		DIODE-PIN	28480	5082-3080
A13A1CR13	1901-0639	4		DIODE-PIN	28480	5082-3080
A13A1CR14	1901-0639	4		DIODE-PIN	28480	5082-3080
A13A1CR15	1901-0639	4		DIODE-PIN	28480	5082-3080
A13A1CR16	1901-0639	4		DIODE-PIN	28480	5082-3080
A13A1CR17	1901-0639	4		DIODE-PIN	28480	5082-3080
A13A1CR18	1901-0639	4		DIODE-PIN	28480	5082-3080
A13A1CR19	1901-0639	4		DIODE-PIN	28480	5082-3080
A13A1CR20	1901-0639	4		DIODE-PIN	28480	5082-3080
A13A1CR21	1901-0639	4		DIODE-PIN	28480	5082-3080
A13A1CR22	1901-0639	4		DIODE-PIN	28480	5082-3080
A13A1CR23	1901-0639	4		DIODE-PIN	28480	5082-3080
A13A1CR24	1901-0639	4		DIODE-PIN	28480	5082-3080
A13A1CR25	1901-0639	4		DIODE-PIN	28480	5082-3080
A13A1CR26	1901-0639	4		DIODE-PIN	28480	5082-3080
A13A1CR27	1901-0639	4		DIODE-PIN	28480	5082-3080
A13A1CR28	1901-0639	4		DIODE-PIN	28480	5082-3080
A13A1CR29	1901-0639	4		DIODE-PIN	28480	5082-3080
A13A1CR30	1901-0639	4		DIODE-PIN	28480	5082-3080
A13A1CR31	1901-0639	4		DIODE-PIN	28480	5082-3080
A13A1CR32	1901-0639	4		DIODE-PIN	28480	5082-3080
A13A1CR33	1901-0639	4		DIODE-PIN	28480	5082-3080
A13A1CR34	1901-0639	4		DIODE-PIN	28480	5082-3080
A13A1CR35	1901-0639	4		DIODE-PIN	28480	5082-3080
A13A1CR36	1901-0639	4		DIODE-PIN	28480	5082-3080
A13A1CR37	1901-0639	4		DIODE-PIN	28480	5082-3080
A13A1CR38	1901-0639	4		DIODE-PIN	28480	5082-3080
A13A1CR39	1901-0639	4		DIODE-PIN	28480	5082-3080
A13A1CR40	1901-0639	4		DIODE-PIN	28480	5082-3080
<b>2427A TO 2722A</b>						
A13A1CR41	1901-1096	9		DIODE-PIN	28480	1901-1096
<b>2828A AND ABOVE</b>						
A13A1CR41	1901-0639	4		DIODE-PIN	28480	1901-0639
A13A1CR42	1901-0639	4		DIODE-PIN	28480	5082-3080
A13A1CR43	1901-0639	4		DIODE-PIN	28480	5082-3080
<b>2427A TO 2722A</b>						
A13A1CR44	1901-1096	9		DIODE-PIN	28480	1901-1096
<b>2828A AND ABOVE</b>						
A13A1CR44	1901-0639	4		DIODE-PIN	28480	1901-0639
A13A1CR45	1901-0639	4		DIODE-PIN	28480	5082-3080
A13A1CR46	1901-0639	4		DIODE-PIN	28480	5082-3080
<b>2427A TO 2510A</b>						
A13A1CR47-CR50				NOT ASSIGNED		
<b>2511A AND ABOVE</b>						
A13A1CR47	1901-0050	3		DIODE-SWITCHING 80V 200MA 2NS D0-35	28480	1901-0050
A13A1CR48	1900-0047	6		DIODE-PIN	28480	1900-0047
A13A1CR49	1900-0047	6		DIODE-PIN	28480	1900-0047
A13A1CR50	1900-0047	6		DIODE-PIN	28480	1900-0047
A13A1CR51	1900-0639	4		DIODE-PIN	28480	5082-3080
A13A1CR52	1900-0639	4		DIODE-PIN	28480	5082-3080
A13A1J1	1250-2090	4		CONNECTOR-RF SMC M SGL-HOLE-RR 50-OHM	28480	1250-2090
	08642-20081	7		ELSTMR COND SMC	28480	08642-20081
A13A1J2	1250-2090	4		CONNECTOR-RF SMC M SGL-HOLE-RR 50-OHM	28480	1250-2090
	08642-20081	7		ELSTMR COND SMC	28480	08642-20081
A13A1J3	1251-8758	5		CONN-POST TYPE .100-PIN-SPCG 8-CONT	28480	1251-8758
A13A1L1				NOT ASSIGNED		
A13A1L2				NOT ASSIGNED		
<b>2427A TO 2722A</b>						
A13A1L3	9135-0080	2	4	INDUCTOR RF-CH-MLD 27NH 5% .102DX.26LG	28480	9135-0080
A13A1L4	9135-0080	2		INDUCTOR RF-CH-MLD 27NH 5% .102DX.26LG	28480	9135-0080
<b>2728A AND ABOVE</b>						
A13A1L3	8159-0005	0		RESISTOR-ZERO OHMS 22 AWG LEAD DIA	28480	8159-0005
A13A1L4	8159-0005	0		RESISTOR-ZERO OHMS 22 AWG LEAD DIA	28480	8159-0005
A13A1L5	9135-0080	2		INDUCTOR RF-CH-MLD 27NH 5% .102DX.26LG	28480	9135-0080
A13A1L6	9135-0080	2		INDUCTOR RF-CH-MLD 27NH 5% .102DX.26LG	28480	9135-0080
A13A1L7	9135-0077	7	2	INDUCTOR RF-CH-MLD 36NH 6% .102DX.26LG	28480	9135-0077
A13A1L8	9135-0077	7		INDUCTOR RF-CH-MLD 36NH 6% .102DX.26LG	28480	9135-0077
A13A1L9	9135-0074	4	2	INDUCTOR RF-CH-MLD 47NH 4% .102DX.26LG	28480	9135-0074
A13A1L10	9135-0074	4		INDUCTOR RF-CH-MLD 47NH 4% .102DX.26LG	28480	9135-0074

See introduction to this section for ordering information.

\* Indicates factory selected value

Table 6-2. Replaceable Parts

Reference Designation	HP Part Number	C D	Qty	Description	Mfr Code	Mfr Part Number
A13A1L11	9135-0072	2		INDUCTOR RF-CH-MLD 56NH 5% .102DX.26LG	28480	9135-0072
A13A1L12	9135-0072	2		INDUCTOR RF-CH-MLD 56NH 5% .102DX.26LG	28480	9135-0072
A13A1L13	9135-0078	8		INDUCTOR RF-CH-MLD 82NH 7% .102DX.26LG	28480	9135-0078
A13A1L14	9135-0078	8		INDUCTOR RF-CH-MLD 82NH 7% .102DX.26LG	28480	9135-0078
A13A1L15	9135-0079	9		INDUCTOR RF-CH-MLD 100NH 5% .102DX.26LG	28480	9135-0079
A13A1L16	9135-0079	9		INDUCTOR RF-CH-MLD 100NH 5% .102DX.26LG	28480	9135-0079
A13A1L17	9140-0530	8		INDUCTOR RF-CH-MLD 150NH 5% .105DX.26LG	28480	9140-0530
A13A1L18	9140-0530	8		INDUCTOR RF-CH-MLD 150NH 5% .105DX.26LG	28480	9140-0530
A13A1L19	9140-0519	3		INDUCTOR RF-CH-MLD 220NH 5% .105DX.26LG	28480	9140-0519
A13A1L20	9140-0519	3		INDUCTOR RF-CH-MLD 220NH 5% .105DX.26LG	28480	9140-0519
A13A1L21	9140-0352	2	2	INDUCTOR RF-CH-MLD 330NH 1% .105DX.26LG	28480	9140-0352
A13A1L22	9140-0310	2	1	INDUCTOR RF-CH-MLD 390NH 5% .105DX.26LG	28480	9140-0310
A13A1L23	9140-0352	2		INDUCTOR RF-CH-MLD 330NH 1% .105DX.26LG	28480	9140-0352
A13A1L24	9140-0353	3	2	INDUCTOR RF-CH-MLD 430NH 1% .105DX.26LG	28480	9140-0353
A13A1L25	9100-0593	9		INDUCTOR RF-CH-MLD 470NH 5% .105DX.26LG	28480	9100-0593
A13A1L26	9140-0353	3		INDUCTOR RF-CH-MLD 430NH 1% .105DX.26LG	28480	9140-0353
A13A1L27	9140-1095	2	2	INDUCTOR RF-CH-MLD 680NH 5% .105DX.26LG	28480	9140-1095
A13A1L28	9140-0526	2	1	INDUCTOR RF-CH-MLD 750NH 5% .105DX.26LG	28480	9140-0526
A13A1L29	9140-1095	2		INDUCTOR RF-CH-MLD 680NH 5% .105DX.26LG	28480	9140-1095
A13A1L30	9140-0333	9	2	INDUCTOR RF-CH-MLD 910NH 5% .105DX.26LG	28480	9140-0333
A13A1L31	9140-0531	9		INDUCTOR RF-CH-MLD 1UH 5% .105DX.26LG	28480	9140-0531
A13A1L32	9140-0333	9		INDUCTOR RF-CH-MLD 910NH 5% .105DX.26LG	28480	9140-0333
A13A1L33	9100-2249	6		INDUCTOR RF-CH-MLD 150NH 10% .105DX.26LG	28480	9100-2249
A13A1L34	9100-2249	6		INDUCTOR RF-CH-MLD 150NH 10% .105DX.26LG	28480	9100-2249
A13A1L35	9100-2250	9		INDUCTOR RF-CH-MLD 180NH 10% .105DX.26LG	28480	9100-2250
A13A1L36	9100-2251	0		INDUCTOR RF-CH-MLD 220NH 10% .105DX.26LG	28480	9100-2251
A13A1L37	9140-0158	6		INDUCTOR RF-CH-MLD 1UH 10% .105DX.26LG	28480	9140-0158
A13A1L38	9140-0158	6		INDUCTOR RF-CH-MLD 1UH 10% .105DX.26LG	28480	9140-0158
A13A1L39	9140-0158	6		INDUCTOR RF-CH-MLD 1UH 10% .105DX.26LG	28480	9140-0158
A13A1L40	9140-0158	6		INDUCTOR RF-CH-MLD 1UH 10% .105DX.26LG	28480	9140-0158
A13A1L41	9140-0144	0	4	INDUCTOR RF-CH-MLD 4.7UH 10% .105DX.26LG	28480	9140-0144
A13A1L42	9140-0144	0		INDUCTOR RF-CH-MLD 4.7UH 10% .105DX.26LG	28480	9140-0144
A13A1L43	9100-1619	2	1	INDUCTOR RF-CH-MLD 6.8UH 10%	28480	9100-1619
A13A1L44	9140-0105	3	4	INDUCTOR RF-CH-MLD 8.2UH 10%	28480	9140-0105
A13A1L45	9100-1627	2		INDUCTOR RF-CH-MLD 39UH 5% .166DX.385LG	28480	9100-1627
A13A1L46	9100-1631	8		INDUCTOR RF-CH-MLD 56UH 5% .166DX.385LG	28480	9100-1631
A13A1L47	9140-0210	1	5	INDUCTOR RF-CH-MLD 100UH 5% .166DX.385LG	28480	9140-0210
A13A1L48	9100-1637	4	1	INDUCTOR RF-CH-MLD 120UH 5% .166DX.385LG	28480	9100-1637
A13A1L49	9140-1087	2		INDUCTOR-FIXED 120-1300 HZ	28480	9140-1087
A13A1L50	9140-1087	2		INDUCTOR-FIXED 120-1300 HZ	28480	9140-1087
A13A1L51	9140-0210	1		INDUCTOR RF-CH-MLD 100UH 5% .166DX.385LG	28480	9140-0210
A13A1L52	9140-0210	1		INDUCTOR RF-CH-MLD 100UH 5% .166DX.385LG	28480	9140-0210
A13A1L53	9140-1088	3	2	INDUCTOR 15.4UH 25% .23D	28480	9140-1088
A13A1L54	9140-1087	2		INDUCTOR-FIXED 120-1300 HZ	28480	9140-1087
A13A1L55	9140-0114	4	2	INDUCTOR RF-CH-MLD 10UH 10% .166DX.385LG	28480	9140-0114
A13A1L56	9140-1088	3		INDUCTOR 15.4UH 25% .23D	28480	9140-1088
A13A1L57	9140-1087	2		INDUCTOR-FIXED 120-1300 HZ	28480	9140-1087
A13A1L58	9140-0114	4		INDUCTOR RF-CH-MLD 10UH 10% .166DX.385LG	28480	9140-0114
A13A1L59				NOT ASSIGNED		
A13A1L60	9140-1087	2		INDUCTOR-FIXED 120-1300 HZ	28480	9140-1087
A13A1L61	9100-1620	5		INDUCTOR RF-CH-MLD 15UH 10% .166DX.385LG	28480	9100-1620
A13A1L62	9140-1087	2		INDUCTOR-FIXED 120-1300 HZ	28480	9140-1087
A13A1L63	9140-0532	0		INDUCTOR RF-CH-MLD 1.2UH 5% .105DX.26LG	28480	9140-0532
A13A1L64	9140-0534	2	1	INDUCTOR RF-CH-MLD 1.5UH 5% .105DX.26LG	28480	9140-0534
A13A1L65	9140-0532	0		INDUCTOR RF-CH-MLD 1.2UH 5% .105DX.26LG	28480	9140-0532
A13A1L66	9140-0309	9	2	INDUCTOR RF-CH-MLD 1.8UH 5% .105DX.26LG	28480	9140-0309
A13A1L67	9140-0537	5	1	INDUCTOR RF-CH-MLD 2.2UH 5% .105DX.26LG	28480	9140-0537
A13A1L68	9140-0309	9		INDUCTOR RF-CH-MLD 1.8UH 5% .105DX.26LG	28480	9140-0309
2427A TO 2510A						
A13A1L69-L71				NOT ASSIGNED		
2511A TO 2533A						
A13A1L69	9140-1088	3		INDUCTOR 17.4UH	28480	9140-1088
A13A1L70	9140-1087	2		INDUCTOR-FXD 120-1300 HZ	28480	9140-1087
A13A1L71	9140-1088	3		INDUCTOR 17.4UH	28480	9140-1088
2534A AND ABOVE						
A13A1L69	9140-1088	3		INDUCTOR 17.4UH	28480	9140-1088
A13A1L70				NOT ASSIGNED		
A13A1L71	9140-1088	3		INDUCTOR 17.4UH	28480	9140-1088
A13A1MP1	0340-0840	8		INSULATOR SLBL-LAC-CMPD	28480	0340-0840

See introduction to this section for ordering information.

\* Indicates factory selected value

Table 6-2. Replaceable Parts

Reference Designation	HP Part Number	C D	Qty	Description	Mfr Code	Mfr Part Number
A13A1Q1	1854-0942	1	1	TRANSISTOR NPN SI PD=2.25W FT=3GHZ	28480	1854-0942
A13A1Q2	1853-0459	3		TRANSISTOR PNP SI PD=625MW FT=200MHZ	28480	1853-0459
A13A1Q3	1854-0720	3		TRANSISTOR NPN SI PD=500MW FT=4GHZ	28480	1854-0720
A13A1R1	0698-3446	3	4	RESISTOR 383 1% .125W F TC=0+-100	24546	C4-1/8-T0-383R-F
A13A1R2	0699-1318	6		RESISTOR 1K 1% .125W F TC=0+-100	28480	0699-1318
<i>2427A TO 2510A</i>						
<i>A13A1R3</i>	0757-0405	4		RESISTOR 162 1% .125W F TC=0+-100	24546	C4-1/8-T0-162R-F
<i>2511A AND ABOVE</i>						
<i>A13A1R3</i>	0698-3439	4		RESISTOR 178 1% .125W F TC=0+-100	24546	C4-1/8-T0-178R-F
A13A1R4	0757-0802	5	1	RESISTOR 162 1% .5W F TC=0+-100	28480	0757-0802
<i>2427A TO 2510A</i>						
<i>A13A1R5</i>	0699-0268	3	12	RESISTOR 45 5% .1W C TC=0+-200	28480	0699-0268
<i>A13A1R6</i>	0699-0268	3		RESISTOR 45 5% .1W C TC=0+-200	28480	0699-0268
<i>A13A1R7</i>	0699-0268	3		RESISTOR 45 5% .1W C TC=0+-200	28480	0699-0268
<i>2511A AND ABOVE</i>						
<i>A13A1R5</i>	0699-1359	5	12	RESISTOR CHIP 42.2	28480	0699-1359
<i>A13A1R6</i>	0699-1359	5	12	RESISTOR CHIP 42.2	28480	0699-1359
<i>A13A1R7</i>	0699-1359	5	12	RESISTOR CHIP 42.2	28480	0699-1359
A13A1R8	0757-0402	1	8	RESISTOR 110 1% .125W F TC=0+-100	24546	C4-1/8-T0-111-F
A13A1R9	0757-0402	1		RESISTOR 110 1% .125W F TC=0+-100	24546	C4-1/8-T0-111-F
A13A1R10	0757-0402	1		RESISTOR 110 1% .125W F TC=0+-100	24546	C4-1/8-T0-111-F
A13A1R11	0757-0402	1		RESISTOR 110 1% .125W F TC=0+-100	24546	C4-1/8-T0-111-F
A13A1R12	0757-0402	1		RESISTOR 110 1% .125W F TC=0+-100	24546	C4-1/8-T0-111-F
A13A1R13	0757-0402	1		RESISTOR 110 1% .125W F TC=0+-100	24546	C4-1/8-T0-111-F
A13A1R14				NOT ASSIGNED		
A13A1R15	0757-0402	1		RESISTOR 110 1% .125W F TC=0+-100	24546	C4-1/8-T0-111-F
A13A1R16	0757-0402	1		RESISTOR 110 1% .125W F TC=0+-100	24546	C4-1/8-T0-111-F
A13A1R17				NOT ASSIGNED		
A13A1R18				NOT ASSIGNED		
A13A1R19	0698-7248	1		RESISTOR 3.16K 1% .05W F TC=0+-100	24546	C3-1/8-T0-3161-F
A13A1R20	0698-7240	3		RESISTOR 1.47K 1% .05W F TC=0+-100	24546	C3-1/8-T0-1471-F
A13A1R21	0698-3397	3	1	RESISTOR 42.2 1% .5W F TC=0+-100	28480	0698-3397
<i>2427A TO 2510A</i>						
<i>A13A1R22</i>	0757-0280	3		RESISTOR 1K 1% .125W F TC=0+-100	24546	C4-1/8-T0-1001-F
<i>2511A AND ABOVE</i>						
<i>A13A1R22</i>	0699-1295	8		RESISTOR 1K 1% .125W F TC=0+-100	28480	0699-1295
A13A1R23	0699-0181	9	1	RESISTOR 178 5% .1W C TC=0+-200	28480	0699-0181
A13A1R24	0698-7248	1		RESISTOR 3.16K 1% .05W F TC=0+-100	24546	C3-1/8-T0-3161-F
A13A1R25	1810-0207	9	3	NETWORK-RES 8-SIP22.0K OHM X 7	01121	208A223
A13A1R26	1810-0207	9		NETWORK-RES 8-SIP22.0K OHM X 7	01121	208A223
A13A1R27	1810-0207	9		NETWORK-RES 8-SIP22.0K OHM X 7	01121	208A223
A13A1R28	1810-0204	6	2	NETWORK-RES 8-SIP1.0K OHM X 7	01121	208A102
A13A1R29	0698-7224	3		RESISTOR 316 1% .05W F TC=0+-100	24546	C3-1/8-T0-316R-F
<i>2427A TO 2510A</i>						
<i>A13A1R30</i>	0699-0268	3		RESISTOR 45 5% .1W C TC=0+-200	28480	0699-0268
<i>A13A1R31</i>	0699-0268	3		RESISTOR 45 5% .1W C TC=0+-200	28480	0699-0268
<i>A13A1R32</i>	0699-0268	3		RESISTOR 45 5% .1W C TC=0+-200	28480	0699-0268
<i>A13A1R33-R37</i>				NOT ASSIGNED		
<i>2511A AND ABOVE</i>						
<i>A13A1R30</i>	0699-1359	5	12	RESISTOR CHIP 42.2	28480	0699-1359
<i>A13A1R31</i>	0699-1359	5	12	RESISTOR CHIP 42.2	28480	0699-1359
<i>A13A1R32</i>	0699-1359	5	12	RESISTOR CHIP 42.2	28480	0699-1359
<i>A13A1R33</i>	0698-7243	6		RESISTOR 1.96K 1% .05W F TC=+-100	24546	C3-1/8-T0-1961-F
<i>2511A TO 2533A</i>						
<i>A13A1R34</i>	0698-7236	7		RESISTOR 1K 1% .05W F TC=+-100	24546	C3-1/8-T0-1001-F
<i>A13A1R35</i>	0698-3441	8		RESISTOR 215 1% .125W F TC=+-100	24546	C4-1/8-T0-215R-F
<i>2534A AND ABOVE</i>						
<i>A13A1R34</i>				NOT ASSIGNED		
<i>A13A1R35</i>				NOT ASSIGNED		
<i>2511A TO 2642A</i>						
<i>A13A1R36</i>	0698-3599	7		RESISTOR 2.15K 1% .25W F TC=+-100	24546	C5-1/4-T0-2151-F
<i>A13A1R37</i>	0757-0397	3		RESISTOR 68.1 1% .125W F TC=+-100	24546	C4-1/8-T0-68R1-F

See introduction to this section for ordering information.

\* Indicates factory selected value



Table 6-2. Replaceable Parts

Reference Designation	HP Part Number	C D	Qty	Description	Mfr Code	Mfr Part Number
2703A AND ABOVE A13A1R36 A13A1R37	0757-0338 0757-0276	2 7		RESISTOR 1K 1% .25W F TC=0+-100 RESISTOR 61.9 1% .125W F TC=0+-100	24546 24546	C5-1/4-TO-1001-F C4-1/8-TO-6192-F
2427A TO 2527A A13A1R38 2529A TO 2550A A13A1R38 2551A TO 2722A A13A1R38 2728A AND ABOVE A13A1R38	0699-1423	4		NOT ASSIGNED NOT ASSIGNED RESISTOR 215 1% .125W F TC=0+-100 NOT ASSIGNED	28480	0699-1423
2427A TO 2527A A13A1R39 2529A TO 2550A A13A1R39 2551A AND ABOVE A13A1R39	0699-1423 0699-1423	4 4		NOT ASSIGNED RESISTOR 215 1% .125W F TC=0+-100 RESISTOR 215 1% .125W F TC=0+-100	28480 28480	0699-1423 0699-1423
A13A1TP1 A13A1TP2 A13A1TP3	0360-0535 0360-0535 1251-2194	0 0 1		TERMINAL TEST POINT PCB TERMINAL TEST POINT PCB CONNECTOR-SGL CONT SKT .021-IN-BSC-SZ	00000 00000 28480	ORDER BY DESCRIPTION ORDER BY DESCRIPTION 1251-2194
2427A TO 2828A A13A1U1 2814A AND ABOVE A13A1U1	1826-0047 1826-0138	8 8		IC PL LOOP 16-DIP-P PKG IC COMPARATOR GP QUAD 14-DIP-P PKG	18324 01295	NE562B LM339N
A13A1U2 A13A1U3 A13A1U4 A13A1U5	1820-1729 1858-0047 1820-1729 1858-0047	3 5 3 5	2	IC LCH TTL LS COM CLEAR 8-BIT TRANSISTOR ARRAY 16-PIN PLSTC DIP IC LCH TTL LS COM CLEAR 8-BIT TRANSISTOR ARRAY 16-PIN PLSTC DIP	01295 13606 01295 13606	SN74LS259N ULN-2003A SN74LS259N ULN-2003A
2427A TO 2809A A13A1U6 2814A AND ABOVE A13A1U6	1826-0759 1826-0138	9 8		IC COMPARATOR GP QUAD 14-DIP-C IC COMPARATOR GP QUAD 14-DIP-C PKG	04713 01295	LM339J LM339N
A13A1W1 A13A1Z1	8159-0005 08642-00062	0 2	1	RESISTOR-ZERO OHMS 22 AWG LEAD DIA G STRP UHF XSTR	28480 28480	8159-0005 08642-00062

See introduction to this section for ordering information.

\* Indicates factory selected value

Table 6-2. Replaceable Parts

Reference Designation	HP Part Number	C D	Qty	Description	Mfr Code	Mfr Part Number
<b>A13A2</b>						
2427A TO 2510A A13A2	08642-60113	0	1	ALC/POWER AMPLIFIER ASSEMBLY	28480	08642-60113
2511A TO 2640A A13A2	08642-60213	0	1	ALC/POWER AMPLIFIER ASSEMBLY	28480	08642-60213
2642A ATO 2728A A13A2	08642-60313	2	1	ALC/POWER AMPLIFIER ASSEMBLY	28480	08642-60313
2801A AND ABOVE A13A2	08642-60413	3	1	ALC/POWER AMPLIFIER ASSEMBLY	28480	08642-60413
A13A2C1	0160-4387	4		CAPACITOR-FXD 47PF +-5% 200VDC CER 0+-30	28480	0160-4387
A13A2C2	0160-4389	6		CAPACITOR-FXD 100PF +-5PF 200VDC CER	28480	0160-4389
A13A2C3	0160-4387	4		CAPACITOR-FXD 47PF +-5% 200VDC CER 0+-30	28480	0160-4387
A13A2C4	0160-4822	2		CAPACITOR-FXD 1000PF +-5% 100VDC CER	28480	0160-4822
A13A2C5	0160-4832	4		CAPACITOR-FXD .01UF +-10% 100VDC CER	28480	0160-4832
A13A2C6	0160-3531	8		CAPACITOR-FXD 2UF +-5% 50VDC MET-POLYC NOT ASSIGNED	28480	0160-3531
A13A2C7	0180-0491	5		CAPACITOR-FXD 10UF+-20% 25VDC TA	28480	0180-0491
A13A2C8						
2427A TO 2728A A13A2C9	0160-0576	5		CAPACITOR-FXD .1UF +-20% 50VDC CER	28480	0160-0576
2801A AND ABOVE A13A2C9				NOT ASSIGNED		
A13A2C10	0160-0576	5		CAPACITOR-FXD .1UF +-20% 50VDC CER	28480	0160-0576
A13A2C11	0160-0576	5		CAPACITOR-FXD .1UF +-20% 50VDC CER	28480	0160-0576
A13A2C12	0160-0576	5		CAPACITOR-FXD .1UF +-20% 50VDC CER	28480	0160-0576
A13A2C13	0160-4524	1		CAPACITOR-FXD 24PF +-5% 200VDC CER 0+-30	51642	200-200-NP0-240J
A13A2C14	0160-0576	5		CAPACITOR-FXD .1UF +-20% 50VDC CER	28480	0160-0576
A13A2C15	0160-0576	5		CAPACITOR-FXD .1UF +-20% 50VDC CER	28480	0160-0576
A13A2C16	0160-0576	5		CAPACITOR-FXD .1UF +-20% 50VDC CER	28480	0160-0576
A13A2C17	0160-0576	5		CAPACITOR-FXD .1UF +-20% 50VDC CER	28480	0160-0576
A13A2C18	0160-0576	5		CAPACITOR-FXD .1UF +-20% 50VDC CER	28480	0160-0576
A13A2C19	0160-0576	5		CAPACITOR-FXD .1UF +-20% 50VDC CER	28480	0160-0576
A13A2C20	0160-0576	5		CAPACITOR-FXD .1UF +-20% 50VDC CER	28480	0160-0576
A13A2C21				NOT ASSIGNED		
2427A TO 2510A A13A2C22	0160-4106	5		CAPACITOR-FXD .1UF +-20% 50VDC CER	51959	1209X104M2P
2511A AND ABOVE A13A2C22	0160-6222	0		CAPACITOR-FXD .1UF +-10% 50VDC CER	28480	0160-6222
A13A2C23	0160-0576	5		CAPACITOR-FXD .1UF +-20% 50VDC CER	28480	0160-0576
2427A TO 2510A A13A2C24	0160-4106	5		CAPACITOR-FXD .1UF +-20% 50VDC CER	51959	1209X104M2P
2511A AND ABOVE A13A2C24	0160-6222	0		CAPACITOR-FXD .1UF +-10% 50VDC CER	28480	0160-6222
A13A2C25	0160-0576	5		CAPACITOR-FXD .1UF +-20% 50VDC CER	28480	0160-0576
A13A2C26				NOT ASSIGNED		
2427A TO 2510A A13A2C27	0160-4106	5		CAPACITOR-FXD .1UF +-20% 50VDC CER	51959	1209X104M2P
2511A AND ABOVE A13A2C27	0160-6222	0		CAPACITOR-FXD .1UF +-10% 50VDC CER	28480	0160-6222
A13A2C28	0160-0576	5		CAPACITOR-FXD .1UF +-20% 50VDC CER	28480	0160-0576
A13A2C29	0160-3873	1		CAPACITOR-FXD 4.7PF +- .5PF 200VDC CER	28480	0160-3873
A13A2C30	0160-0576	5		CAPACITOR-FXD .1UF +-20% 50VDC CER	28480	0160-0576
2427A TO 2510A A13A2C31	0160-4077	9		CAPACITOR-FXD .01UF +-20% 50VDC CER	51959	0805X103K2P
A13A2C32	0160-4077	9		CAPACITOR-FXD .01UF +-20% 50VDC CER	51959	0805X103K2P
A13A2C33	0160-3641	1	2	CAPACITOR-FXD 4700PF +-10% 50VDC CER	26654	1BX050S472K(D)
A13A2C34	0160-3641	1	1	CAPACITOR-FXD 4700PF +-10% 50VDC CER	26654	1BX050S472K(D)
2511A AND ABOVE A13A2C31	0160-5945	2		CAPACITOR-FXD .01UF +-10% 50VDC CER	28480	0160-5945
A13A2C32	0160-5945	2		CAPACITOR-FXD .01UF +-10% 50VDC CER	28480	0160-5945
A13A2C33	0160-6218	4		CAPACITOR-FXD 4700PF +-10% 50VDC CER	28480	0160-6218
A13A2C34	0160-6218	4	2	CAPACITOR-FXD 4700PF +-10% 50VDC CER	28480	0160-6218
A13A2C35	0160-0576	5		CAPACITOR-FXD .1UF +-20% 50VDC CER	28480	0160-0576
A13A2C36	0160-0576	5		CAPACITOR-FXD .1UF +-20% 50VDC CER	28480	0160-0576
A13A2C37	0160-0576	5		CAPACITOR-FXD .1UF +-20% 50VDC CER	28480	0160-0576

See introduction to this section for ordering information.

\* Indicates factory selected value

Table 6-2. Replaceable Parts

Reference Designation	HP Part Number	C D	Qty	Description	Mfr Code	Mfr Part Number
A13A2C38	0160-4386	3	1	CAPACITOR-FXD 33PF +-5% 200VDC CER 0+-30	28480	0160-4386
A13A2C39	0160-5954	3		CAPACITOR-FXD 220PF +-5% 50VDC CER 0+-30	28480	0160-5954
A13A2C40	0180-0491	5		CAPACITOR-FXD 10UF+-20% 25VDC TA	28480	0180-0491
A13A2C41	0180-0491	5		CAPACITOR-FXD 10UF+-20% 25VDC TA	28480	0180-0491
A13A2C42	0160-0576	5		CAPACITOR-FXD .1UF +-20% 50VDC CER	28480	0160-0576
A13A2C43	0160-3878	6		CAPACITOR-FXD 1000PF +-20% 100VDC CER	28480	0160-3878
A13A2C44	0160-3878	6		CAPACITOR-FXD 1000PF +-20% 100VDC CER	28480	0160-3878
A13A2C45	0160-3878	6		CAPACITOR-FXD 1000PF +-20% 100VDC CER	28480	0160-3878
A13A2C46	0160-3878	6		CAPACITOR-FXD 1000PF +-20% 100VDC CER	28480	0160-3878
A13A2C47	0160-0576	5		CAPACITOR-FXD .1UF +-20% 50VDC CER	28480	0160-0576
A13A2C48	0180-0491	5		CAPACITOR-FXD 10UF+-20% 25VDC TA	28480	0180-0491
A13A2C49	0180-0491	5		CAPACITOR-FXD 10UF+-20% 25VDC TA	28480	0180-0491
A13A2C50	0160-5216	0	2	CAPACITOR-FXD .1UF +-10% 100VDC CER	28480	0160-5216
A13A2C51	0160-0576	5		CAPACITOR-FXD .1UF +-20% 50VDC CER	28480	0160-0576
A13A2C52	0160-5216	0		CAPACITOR-FXD .1UF +-10% 100VDC CER	28480	0160-5216
A13A2C53	0160-0576	5		CAPACITOR-FXD .1UF +-20% 50VDC CER	28480	0160-0576
A13A2C54	0160-0576	5		CAPACITOR-FXD .1UF +-20% 50VDC CER	28480	0160-0576
A13A2C55	0160-0576	5		CAPACITOR-FXD .1UF +-20% 50VDC CER	28480	0160-0576
A13A2C56	0160-0576	5		CAPACITOR-FXD .1UF +-20% 50VDC CER	28480	0160-0576
A13A2C57	0160-0576	5		CAPACITOR-FXD .1UF +-20% 50VDC CER	28480	0160-0576
A13A2C58				NOT ASSIGNED		
A13A2C59	0160-0576	5		CAPACITOR-FXD .1UF +-20% 50VDC CER	28480	0160-0576
A13A2C60	0160-4832	4		CAPACITOR-FXD .01UF +-10% 100VDC CER	28480	0160-4832
A13A2CR1	1901-0539	3		DIODE-SM SIG SCHOTTKY	28480	1901-0539
A13A2CR2	1901-0539	3		DIODE-SM SIG SCHOTTKY	28480	1901-0539
A13A2CR3	1901-0886	3	1	DIODE-SCHOTTKY 20V 1A	28480	1901-0886
A13A2CR4	1901-0050	3		DIODE-SWITCHING 80V 200MA 2NS DO-35	28480	1901-0050
A13A2CR5	1901-0050	3		DIODE-SWITCHING 80V 200MA 2NS DO-35	28480	1901-0050
2427A TO 2622A A13A2CR6	1901-0539	3		DIODE-SM SIG SCHOTTKY	28480	1901-0539
2630A TO 2703A A13A2CR6				NOT ASSIGNED		
2709A AND ABOVE A13A2CR6	1901-0539	3		DIODE-SM SIG SCHOTTKY	28480	1901-0539
A13A2CR7	1901-0050	3		DIODE-SWITCHING 80V 200MA 2NS DO-35	28480	1901-0050
A13A2CR8	1901-0050	3		DIODE-SWITCHING 80V 200MA 2NS DO-35	28480	1901-0050
A13A2CR9				NOT ASSIGNED		
A13A2CR10				NOT ASSIGNED		
A13A2CR11	1901-0050	3		DIODE-SWITCHING 80V 200MA 2NS DO-35	28480	1901-0050
A13A2CR12	1901-0050	3		DIODE-SWITCHING 80V 200MA 2NS DO-35	28480	1901-0050
A13A2CR13				NOT ASSIGNED		
A13A2CR14	1901-0050	3		DIODE-SWITCHING 80V 200MA 2NS DO-35	28480	1901-0050
2427A TO 2640A A13A2CR15				NOT ASSIGNED		
2642A AND ABOVE A13A2CR15	1901-0050	3		DIODE-SWITCHING 80V 200MA 2NS DO-35	28480	1901-0050
A13A2E1	9170-0029	3		CORE-SHIELDING BEAD	28480	9170-0029
A13A2FL1	9135-0214	4		FILTER-HIGH PASS PIN STYLE-TERMS	28480	9135-0214
A13A2FL2	9135-0214	4		FILTER-HIGH PASS PIN STYLE-TERMS	28480	9135-0214
A13A2FL3	9135-0214	4		FILTER-HIGH PASS PIN STYLE-TERMS	28480	9135-0214
A13A2FL4	9135-0214	4		FILTER-HIGH PASS PIN STYLE-TERMS	28480	9135-0214
A13A2FL5	9135-0214	4		FILTER-HIGH PASS PIN STYLE-TERMS	28480	9135-0214
A13A2FL6	9135-0214	4		FILTER-HIGH PASS PIN STYLE-TERMS	28480	9135-0214
A13A2FL7	9135-0214	4		FILTER-HIGH PASS PIN STYLE-TERMS	28480	9135-0214
A13A2FL8	9135-0214	4		FILTER-HIGH PASS PIN STYLE-TERMS	28480	9135-0214
A13A2FL9	9135-0226	8	1	FILTER-LOW PASS WIRE-LEAD-TERMS	28480	9135-0226
A13A2FL10	9135-0214	4		FILTER-HIGH PASS PIN STYLE-TERMS	28480	9135-0214
A13A2FL11	9135-0214	4		FILTER-HIGH PASS PIN STYLE-TERMS	28480	9135-0214

See introduction to this section for ordering information.

\* Indicates factory selected value

Table 6-2. Replaceable Parts

Reference Designation	HP Part Number	C D	Qty	Description	Mfr Code	Mfr Part Number
A13A2J1	1251-8105	6	3	CONN-POST TYPE .100-PIN-SPCG 16-CONT	28480	1251-8105
	1251-5595	2		POLARIZING KEY-POST CONN	28480	1251-5595
A13A2J2	1250-2090	4		CONNECTOR-RF SMC M SGL-HOLE-RR 50-OHM	28480	1250-2090
	08642-20081	7		ELSTMR COND SMC	28480	08642-20081
A13A2J3	08642-80018	6		CONNECTOR-RF	28480	08642-80018
	08642-20079	3		ELSTMR CNDCT SMA	28480	08642-20079
A13A2J4	1250-2090	4		CONNECTOR-RF SMC M SGL-HOLE-RR 50-OHM	28480	1250-2090
	08642-20081	7		ELSTMR COND SMC	28480	08642-20081
A13A2J5	1250-2090	4		CONNECTOR-RF SMC M SGL-HOLE-RR 50-OHM	28480	1250-2090
	08642-20081	7		ELSTMR COND SMC	28480	08642-20081
A13A2J6	1250-2090	4		CONNECTOR-RF SMC M SGL-HOLE-RR 50-OHM	28480	1250-2090
	08642-20081	7		ELSTMR COND SMC	28480	08642-20081
A13A2J7	1251-8758	5		CONN-POST TYPE .100-PIN-SPCG 8-CONT	28480	1251-8758
A13A2L1	9140-0105	3		INDUCTOR RF-CH-MLD 8.2UH 10%	28480	9140-0105
A13A2L2	9140-0105	3		INDUCTOR RF-CH-MLD 8.2UH 10%	28480	9140-0105
A13A2L3	9140-1087	2	INDUCTOR-FIXED 120-1300 HZ	28480	9140-1087	
A13A2L4	9140-1087	2	INDUCTOR-FIXED 120-1300 HZ	28480	9140-1087	
A13A2L5			NOT ASSIGNED			
A13A2L6			NOT ASSIGNED			
A13A2L7			NOT ASSIGNED			
A13A2L8	9140-1087	2	INDUCTOR-FIXED 120-1300 HZ	28480	9140-1087	
A13A2L9	9140-1087	2	INDUCTOR-FIXED 120-1300 HZ	28480	9140-1087	
A13A2L10	9140-1087	2	INDUCTOR-FIXED 120-1300 HZ	28480	9140-1087	
A13A2L11	9140-1087	2	INDUCTOR-FIXED 120-1300 HZ	28480	9140-1087	
A13A2L12	9140-1087	2	INDUCTOR-FIXED 120-1300 HZ	28480	9140-1087	
A13A2L13	9140-1087	2	INDUCTOR-FIXED 120-1300 HZ	28480	9140-1087	
A13A2L14	9140-1087	2	INDUCTOR-FIXED 120-1300 HZ	28480	9140-1087	
A13A2L15	9140-1087	2	INDUCTOR-FIXED 120-1300 HZ	28480	9140-1087	
A13A2L16			NOT ASSIGNED			
A13A2L17			NOT ASSIGNED			
A13A2L18			NOT ASSIGNED			
A13A2L19	9140-1087	2	INDUCTOR-FIXED 120-1300 HZ	28480	9140-1087	
A13A2MP1	08642-20088	4	1	CONTACT-FINGER	28480	08642-20088
A13A2Q1	1854-1009	3	TRANSISTOR NPN SI PD=580MW	28480	1854-1009	
A13A2Q2	1853-0405	9	TRANSISTOR PNP SI PD=300MW FT=850MHZ	04713	2N4209	
A13A2Q3	1855-0420	2	TRANSISTOR J-FET 2N4391 N-CHAN D-MODE	01295	2N4391	
A13A2Q4	1855-0420	2	TRANSISTOR J-FET 2N4391 N-CHAN D-MODE	01295	2N4391	
A13A2Q5	1854-0720	3	TRANSISTOR NPN SI PD=500MW FT=4GHZ	28480	1854-0720	
A13A2Q6			NOT ASSIGNED			
A13A2Q7	1855-0560	1	3	TRANSISTOR MOSFET N-CHAN E-MODE TO-52 SI	28480	1855-0560
A13A2Q8	1853-0459	3	TRANSISTOR PNP SI PD=625MW FT=200MHZ	28480	1853-0459	
A13A2Q9	1855-0560	1	TRANSISTOR MOSFET N-CHAN E-MODE TO-52 SI	28480	1855-0560	
A13A2Q10	1853-0459	3	TRANSISTOR PNP SI PD=625MW FT=200MHZ	28480	1853-0459	
2427A TO 2703A A13A2Q11				NOT ASSIGNED		
2709A AND ABOVE A13A2Q11	1853-0459	3	TRANSISTOR PNP SI PD=625MW FT=200MHZ	28480	1853-0459	
A13A2R1	0698-8625	0	2	RESISTOR 1K .1% .1W F TC=0+-5	28480	0698-8625
A13A2R2	0698-7236	7	RESISTOR 1K 1% .05W F TC=0+-100	24546	C3-1/8-T0-1001-F	
A13A2R3	0698-7260	7	RESISTOR 10K 1% .05W F TC=0+-100	24546	C3-1/8-T0-1002-F	
A13A2R4			NOT ASSIGNED			
A13A2R5	0698-7260	7	RESISTOR 10K 1% .05W F TC=0+-100	24546	C3-1/8-T0-1002-F	
A13A2R6	0698-7236	7	RESISTOR 1K 1% .05W F TC=0+-100	24546	C3-1/8-T0-1001-F	
A13A2R7	0698-7236	7	RESISTOR 1K 1% .05W F TC=0+-100	24546	C3-1/8-T0-1001-F	
A13A2R8	0698-7252	7	RESISTOR 4.64K 1% .05W F TC=0+-100	24546	C3-1/8-T0-4641-F	
A13A2R9	0757-1002	9	RESISTOR 61.9 1% .5W F TC=0+-100	28480	0757-1002	
A13A2R10	0699-1419	8	RESISTOR 147 1% .125W F TC=0+-100	28480	0699-1419	
A13A2R11	0698-7260	7	RESISTOR 10K 1% .05W F TC=0+-100	24546	C3-1/8-T0-1002-F	
A13A2R12	0699-1419	8	RESISTOR 147 1% .125W F TC=0+-100	28480	0699-1419	
A13A2R13	0698-7212	9	RESISTOR 100 1% .05W F TC=0+-100	24546	C3-1/8-T0-100R-F	
A13A2R14	0698-7244	7	RESISTOR 2.15K 1% .05W F TC=0+-100	24546	C3-1/8-T0-2151-F	
A13A2R15	0698-7247	0	RESISTOR 2.87K 1% .05W F TC=0+-100	24546	C3-1/8-T0-2871-F	
A13A2R16	0698-7188	8	RESISTOR 10 1% .05W F TC=0+-100	24546	C3-1/8-T0-10R-F	
A13A2R17	0698-7247	0	RESISTOR 2.87K 1% .05W F TC=0+-100	24546	C3-1/8-T0-2871-F	
A13A2R18	0698-7229	8	RESISTOR 511 1% .05W F TC=0+-100	24546	C3-1/8-T0-511R-F	
A13A2R19	0698-7252	7	RESISTOR 4.64K 1% .05W F TC=0+-100	24546	C3-1/8-T0-4641-F	
A13A2R20	0698-7250	5	RESISTOR 3.83K 1% .05W F TC=0+-100	24546	C3-1/8-T0-3831-F	
A13A2R21	0698-7240	3	RESISTOR 1.47K 1% .05W F TC=0+-100	24546	C3-1/8-T0-1471-F	
2427A TO 2510A A13A2R22	0698-7268	5	RESISTOR 21.5K 1% .05W F TC=0+-100	24546	C3-1/8-T0-2152-F	
2511A AND ABOVE A13A2R22	0698-7269	6	RESISTOR 23.7K 1% .05W F TC=0+-100	24546	C3-1/8-T0-2372-F	

See introduction to this section for ordering information.

\* Indicates factory selected value

Table 6-2. Replaceable Parts

Reference Designation	HP Part Number	C D	Qty	Description	Mfr Code	Mfr Part Number
A13A2R23	0698-8615	8		RESISTOR 75K 1% .05W F TC=0+-100	28480	0698-8615
A13A2R24	0698-7260	7		RESISTOR 10K 1% .05W F TC=0+-100	24546	C3-1/8-T0-1002-F
A13A2R25				NOT ASSIGNED		
A13A2R26	0698-7237	8	1	RESISTOR 1.1K 1% .05W F TC=0+-100	24546	C3-1/8-T0-1101-F
A13A2R27	0698-7276	5	3	RESISTOR 46.4K 1% .05W F TC=0+-100	24546	C3-1/8-T0-4642-F
A13A2R28	0698-7247	0		RESISTOR 2.87K 1% .05W F TC=0+-100	24546	C3-1/8-T0-2871-F
A13A2R29	0698-7220	9		RESISTOR 215 1% .05W F TC=0+-100	24546	C3-1/8-T0-215R-F
A13A2R30	0757-0420	3		RESISTOR 750 1% .125W F TC=0+-100	24546	C4-1/8-T0-751-F
A13A2R31	0699-1423	4		RESISTOR 215 1% .125W F TC=0+-100	28480	0699-1423
A13A2R32	0698-3442	9	2	RESISTOR 237 1% .125W F TC=0+-100	24546	C4-1/8-T0-237R-F
A13A2R33	0699-1360	8		RESISTOR 46.4 1% .125W F TC=0+-100	28480	0699-1360
A13A2R34	0699-1360	8		RESISTOR 46.4 1% .125W F TC=0+-100	28480	0699-1360
A13A2R35	0698-8827	4		RESISTOR 1M 1% .125W F TC=0+-100	28480	0698-8827
A13A2R36	0757-0416	7		RESISTOR 511 1% .125W F TC=0+-100	24546	C4-1/8-T0-511R-F
A13A2R37	0699-1423	4		RESISTOR 215 1% .125W F TC=0+-100	28480	0699-1423
A13A2R38	0698-3442	9		RESISTOR 237 1% .125W F TC=0+-100	24546	C4-1/8-T0-237R-F
2427A TO 2640A						
A13A2R39	0699-1360	8		RESISTOR 46.4 1% .125W F TC=0+-100	28480	0699-1360
A13A2R40	0699-1360	8		RESISTOR 46.4 1% .125W F TC=0+-100	28480	0699-1360
A13A2R41	0699-1360	8		RESISTOR 46.4 1% .125W F TC=0+-100	28480	0699-1360
2642A AND ABOVE						
A13A2R39	0699-1359	5		RESISTOR 42.2 1% .125W F TC=0+-100	28480	0699-1359
A13A2R40	0699-1359	5		RESISTOR 42.2 1% .125W F TC=0+-100	28480	0699-1359
A13A2R41	0699-1359	5		RESISTOR 42.2 1% .125W F TC=0+-100	28480	0699-1359
A13A2R42	0698-3400	9		RESISTOR 147 1% .5W F TC=0+-100	28480	0698-3400
A13A2R43	0757-0179	9	3	RESISTOR 196 1% .25W F TC=0+-100	24546	C5-1/4-T0-196R-F
A13A2R44	0757-0179	9		RESISTOR 196 1% .25W F TC=0+-100	24546	C5-1/4-T0-196R-F
A13A2R45	0698-7236	7		RESISTOR 1K 1% .05W F TC=0+-100	24546	C3-1/8-T0-1001-F
A13A2R46	0699-1360	8		RESISTOR 46.4 1% .125W F TC=0+-100	28480	0699-1360
A13A2R47				NOT ASSIGNED		
A13A2R48	0698-7254	9		RESISTOR 5.62K 1% .05W F TC=0+-100	24546	C3-1/8-T0-5621-F
A13A2R49	0698-7256	1		RESISTOR 6.81K 1% .05W F TC=0+-100	24546	C3-1/8-T0-6811-F
A13A2R50	0698-3102	8		RESISTOR 237 1% .5W F TC=0+-100	28480	0698-3102
A13A2R51	0698-3102	8		RESISTOR 237 1% .5W F TC=0+-100	28480	0698-3102
2427A TO 2709A						
A13A2R52	0699-1206	1	1	RESISTOR 127 1% 2W MO TC=0+-200	28480	0699-1206
2722A AND ABOVE						
A13A2R52	0699-2301	9		RESISTOR 107 1% 2W MO TC=0+-200	28480	0699-2301
A13A2R53	0698-7255	0		RESISTOR 6.19K 1% .05W F TC=0+-100	24546	C3-1/8-T0-6191-F
A13A2R54	0698-7259	4		RESISTOR 9.09K 1% .05W F TC=0+-100	24546	C3-1/8-T0-9091-F
A13A2R55	0698-7271	0	5	RESISTOR 28.7K 1% .05W F TC=0+-100	24546	C3-1/8-T0-2872-F
A13A2R56	0698-3260	9	4	RESISTOR 464K 1% .125W F TC=0+-100	28480	0698-3260
A13A2R57	0698-3260	9		RESISTOR 464K 1% .125W F TC=0+-100	28480	0698-3260
A13A2R58	0757-1090	5		RESISTOR 261 1% .5W F TC=0+-100	28480	0757-1090
A13A2R59	0698-7271	0		RESISTOR 28.7K 1% .05W F TC=0+-100	24546	C3-1/8-T0-2872-F
A13A2R60	0699-0303	7	2	RESISTOR 1.33K 1% .1W F TC=0+-5	28480	0699-0303
2427A TO 2510A						
A13A2R61	0698-7244	7		RESISTOR 2.15K 1% .05W F TC=0+-100	24546	C3-1/8-T0-2151-F
2511A AND ABOVE						
A13A2R61				NOT ASSIGNED		
A13A2R62	0698-7203	8		RESISTOR 42.2 1% .05W F TC=0+-100	24546	C3-1/8-T0-42R2-F
A13A2R63	0698-8625	0		RESISTOR 1K .1% .1W F TC=0+-5	28480	0698-8625
A13A2R64	0698-7236	7		RESISTOR 1K 1% .05W F TC=0+-100	24546	C3-1/8-T0-1001-F
A13A2R65				NOT ASSIGNED		
A13A2R66	0698-7236	7		RESISTOR 1K 1% .05W F TC=0+-100	24546	C3-1/8-T0-1001-F
A13A2R67	0698-7236	7		RESISTOR 1K 1% .05W F TC=0+-100	24546	C3-1/8-T0-1001-F
A13A2R68	0698-7188	8		RESISTOR 10 1% .05W F TC=0+-100	24546	C3-1/8-T0-10R-F
A13A2R69	0698-8827	4		RESISTOR 1M 1% .125W F TC=0+-100	28480	0698-8827
A13A2R70	0698-7265	2		RESISTOR 16.2K 1% .05W F TC=0+-100	24546	C3-1/8-T0-1622-F

See introduction to this section for ordering information.

\* Indicates factory selected value

Table 6-2. Replaceable Parts

Reference Designation	HP Part Number	C D	Qty	Description	Mfr Code	Mfr Part Number
A13A2R71	0698-7238	9	4	RESISTOR 1.21K 1% .05W F TC=0+-100	24546	C3-1/8-T0-1211-F
A13A2R72	0698-8958	2		RESISTOR 511K 1% .125W F TC=0+-100	28480	0698-8958
A13A2R73	0698-8958	2		RESISTOR 511K 1% .125W F TC=0+-100	28480	0698-8958
A13A2R74				NOT ASSIGNED		
A13A2R75	0698-7188	8		RESISTOR 10 1% .05W F TC=0+-100	24546	C3-1/8-T0-10R-F
A13A2R76				NOT ASSIGNED		
A13A2R77	2100-1986	9	1	RESISTOR-TRMR 1K 10% C TOP-ADJ 1-TRN	73138	82PR1K
A13A2R78	0698-7230	1			RESISTOR 562 1% .05W F TC=0+-100	24546
<i>2427A TO 2703A</i>				NOT ASSIGNED		
<i>A13A2R79</i>				NOT ASSIGNED		
<i>A13A2R80</i>				NOT ASSIGNED		
<i>A13A2R81</i>				NOT ASSIGNED		
<i>2709A AND ABOVE</i>						
<i>A13A2R79</i>	0698-7276	5		RESISTOR 46.4K 1% .05W F TC=0+-100	24546	C3-1/8-T0-4642-F
<i>A13A2R80</i>	0698-7260	7		RESISTOR 10K 1% .05W F TC=0+-100	24546	C3-1/8-T0-1002-F
<i>A13A2R81</i>	0698-7271	0		RESISTOR 28.7K 1% .05W F TC=0+-100	24546	C3-1/8-T0-2872-F
A13A2TP1	0360-0535	0		TERMINAL TEST POINT PCB	00000	ORDER BY DESCRIPTION
A13A2TP2	0360-0535	0		TERMINAL TEST POINT PCB	00000	ORDER BY DESCRIPTION
A13A2TP3	0360-0535	0		TERMINAL TEST POINT PCB	00000	ORDER BY DESCRIPTION
A13A2TP4	0360-0535	0		TERMINAL TEST POINT PCB	00000	ORDER BY DESCRIPTION
A13A2TP5	0360-0535	0		TERMINAL TEST POINT PCB	00000	ORDER BY DESCRIPTION
A13A2TP6	0360-0535	0		TERMINAL TEST POINT PCB	00000	ORDER BY DESCRIPTION
A13A2TP7	0360-0535	0		TERMINAL TEST POINT PCB	00000	ORDER BY DESCRIPTION
A13A2TP8	0360-0535	0		TERMINAL TEST POINT PCB	00000	ORDER BY DESCRIPTION
A13A2TP9	0360-0535	0		TERMINAL TEST POINT PCB	00000	ORDER BY DESCRIPTION
A13A2TP10	0360-0535	0		TERMINAL TEST POINT PCB	00000	ORDER BY DESCRIPTION
A13A2TP11	1251-2194	1		CONNECTOR-SGL CONT SKT .021-IN-BSC-SZ	28480	1251-2194
A13A2U1	1826-0605	4	4	IC MULTIPLXR 8-CHAN-ANLG 16-DIP-C PKG	17856	DG508BK
A13A2U2	1826-0412	1			IC COMPARATOR PRCN DUAL 8-DIP-P PKG	27014
<i>2427A TO 2709</i>						
<i>A13A2U3</i>	08642-67001	9	1	UHF POWER AMP	28480	08642-67001
<i>2722A AND ABOVE</i>						
<i>A13A2U3</i>	08642-67013	3	1	UHF POWER AMP	28480	08642-67013
A13A2U4	1251-3172	7		CONNECTOR-SGL CONT SKT .03-IN-BSC-SZ RND	28480	1251-3172
	1820-1416	5		IC SCHMITT-TRIG TTL LS INV HEX 1-INP	01295	SN74LS14N
A13A2U5	1820-1212	9		IC FF TTL LS J-K NEG-EDGE-TRIG	01295	SN74LS112AN
A13A2U6	1820-1433	6		IC SHF-RGTR TTL LS R-S SERIAL-IN PRL-OUT	01295	SN74LS164N
A13A2U7	1820-1858	9		IC FF TTL LS D-TYPE OCTL	01295	SN74LS377N
<i>2427A TO 2801A</i>						
<i>A13A2U8</i>	1826-0759	9		IC COMPARATOR GP QUAD 14-DIP-C PKG	04713	LM339J
<i>2809A AND ABOVE</i>						
<i>A13A2U8</i>	1826-0138	8		IC COMPARATOR GP QUAD 14-DIP-C PKG	01295	LM339N
A13A2U9	1826-0783	9		IC OP AMP LOW-NOISE 8-DIP-C PKG	52063	XR5534ACN
A13A2U10	1820-1858	9		IC FF TTL LS D-TYPE OCTL	01295	SN74LS377N
A13A2U11	1820-1433	6		IC SHF-RGTR TTL LS R-S SERIAL-IN PRL-OUT	01295	SN74LS164N
A13A2U12	1820-1433	6		IC SHF-RGTR TTL LS R-S SERIAL-IN PRL-OUT	01295	SN74LS164N
A13A2U13	1820-1858	9		IC FF TTL LS D-TYPE OCTL	01295	SN74LS377N
A13A2U14	1826-0896	5	2	D/A 12-BIT 24-CBRZ/SDR BPLR	28480	1826-0896
A13A2U15	1826-0889	6	2	IC OP AMP LOW-NOISE DUAL 14-DIP-C PKG	52063	XR5533AN(PER HP DWG)
A13A2U16	1826-0889	6		IC OP AMP LOW-NOISE DUAL 14-DIP-C PKG	52063	XR5533AN(PER HP DWG)
A13A2U17	1820-0224	1		IC OP AMP SPCL TO-99 PKG	27014	LH0002CH
	1205-0011	0		HEAT SINK TO-5/TO-39-CS	28480	1205-0011
A13A2VR1	1902-0962	8	1	DIODE-ZNR 15V 5% DO-35 PD=.4w TC=+.087%	28480	1902-0962
A13A2Z1	1906-0279	8	2	DIODE-BM LD QUAD RINGS	28480	1906-0279
A13A2Z2	1906-0279	8			DIODE-BM LD QUAD RINGS	28480
A13A2Z3	9100-4393	5	2	XFMR BALUN 36AWG	28480	9100-4393
A13A2Z4	9100-4393	5			XFMR BALUN 36AWG	28480

See introduction to this section for ordering information.

\* Indicates factory selected value

Table 6-2. Replaceable Parts

Reference Designation	HP Part Number	C D	Qty	Description	Mfr Code	Mfr Part Number
<b>A14</b>						
A14	08642-60899	9	1	HETERODYNE MODULE	28480	08642-60899
A14	08642-69899	7	1	HETERODYNE MODULE (RESTORED)		
A14FL1	08642-80012	0		FILTER-EMI 7 POS	28480	08642-80012
A14MP1	08642-20019	1	1	COVER HET LO	28480	08642-20019
A14MP2	08642-40052	4	3	GASKET FD/THRU 2	28480	08642-40052
A14MP3	08642-00058	6	1	COV MXR ACS HET	28480	08642-00058
A14MP4	0515-1101	7		SCREW-MACH M4 X 0.7 8MM-LG 90-DEG-FLH-HD (ATTACH ACCESS COVER TO COVER)	28480	0515-1101
A14MP5	08642-20029	3		HEATSINK XSTOR	28480	08642-20029
A14MP6	3050-0891	7	6	WASHER-FL MTL C 3.0 MM 3.3-MM-ID	28480	3050-0891
A14MP7	2190-0584	0	12	WASHER-LK HLCL 3.0 MM 3.1-MM-ID	28480	2190-0584
A14MP8	0515-0680	5	8	SCREW-MACH M3 X 0.5 6MM-LG PAN-HD (ATTACH SWITCH TO BOARD)	28480	0515-0680
A14MP9	08642-20020	4	1	BASE OUTPUT HET	28480	08642-20020
A14MP10	08642-00001	9		GASKET 7 P FILTR	28480	08642-00001
A14MP11	0515-1521	5		SCREW-MACH M3 X 0.5 5MM-LG 90-DEG-FLH-HD (ATTACH FILTER TO BASE)	28480	0515-1521
A14MP12	08642-00121	4		FOAM-COND SAW GD	28480	08642-00121
A14MP13	0515-0684	9		SCREW-MACH M4 X 0.7 6MM-LG PAN-HD (ATTACH BOARDS TO BASE)	28480	0515-0684
A14MP14	08642-20021	5	1	COVER HET	28480	08642-20001
A14MP15	0515-0381	3		SCREW-MACH M4 X 0.7 10MM-LG PAN-HD (ATTACH COVERS TO BASE)	00000	ORDER BY DESCRIPTION
A14MP16	08642-40057	9		GASKET FEEDTHRU	28480	08642-40057
A14MP17	8160-0472	8		RFI ROUND STRIP BE-CU SN-PL .093-IN-OD (SPIRA SHIELD)	28480	8160-0472
A14MP18	08642-00050	8		SLIDE-MODUL 57R4 (FRONT)	28480	08642-00050
A14MP19	08642-00054	2	1	SLIDE-MODULE R7 (REAR)	28480	08642-00054
A14MP20	0515-1102	8		SCREW-MACH M3 X 0.5 8MM-LG 90-DEG-FLH-HD (ATTACH MODULE SLIDE TO BASE)	28480	0515-1102
A14MP21	08642-80070	0	1	LABEL-HET 60007	28480	08642-80070
A14MP22	1400-0249	0	1	CABLE TIE .062-.625-DIA .091-WD NYL	06383	PLT1M-8
2427A TO 2509A A14U1	08642-60098	1	1	ASSY HET SWITCH	28480	08642-60098
2510A AND ABOVE A14U1	08642-60958	5	1	ASSY HET SWITCH	28480	08642-60958
A14W1	08642-60070	8	1	CBL-COAX 916 (A14A2J4 TO A14A3J2)	28480	08642-60070
A14W2	08642-60091	3	1	CBL COAX 912 (A14A3J3 TO A14U1J1)	28480	08642-60091
A14W3	08642-60090	2	1	CBL COAX 914 (A14A3J1 TO A14U1J4)	28480	08642-60090
A14W4	08642-60085	5	1	CBL-RY HET-SWTCH (A14U1 TO A14A3J5)	28480	08642-60085

See introduction to this section for ordering information.

\* Indicates factory selected value





Table 6-2. Replaceable Parts

Reference Designation	HP Part Number	C D	Qty	Description	Mfr Code	Mfr Part Number
<b>A14A1</b>				NOT ASSIGNED		
<i>2427A TO 2507A</i> <b>A14A2</b>	08642-60115	2	1	HETERODYNE LOCAL OSCILLATOR ASSEMBLY	28480	08642-60115
<i>2509A TO 2527A</i> <b>A14A2</b>	08642-60215	3	1	HETERODYNE LOCAL OSCILLATOR ASSEMBLY	28480	08642-60215
<i>2526A AND ABOVE</i> <b>A14A2</b>	08642-60315	4	1	HETERODYNE LOCAL OSCILLATOR ASSEMBLY	28480	08642-60215
A14A2C1	0160-4040	6		CAPACITOR-FXD 1000PF +-5% 100VDC CER	28480	0160-4040
A14A2C2	0160-3879	7		CAPACITOR-FXD .01UF +-20% 100VDC CER	28480	0160-3879
A14A2C3	0160-4512	7	1	CAPACITOR-FXD 120PF +-5% 200VDC CER	28480	0160-4512
A14A2C4	0160-4768	5		CAPACITOR-FXD 470PF +-5% 100VDC CER	28480	0160-4768
A14A2C5	0160-0574	3	1	CAPACITOR-FXD .022UF +-20% 100VDC CER	28480	0160-0574
A14A2C6	0160-3879	7		CAPACITOR-FXD .01UF +-20% 100VDC CER	28480	0160-3879
A14A2C7	0160-3874	2		CAPACITOR-FXD 10PF +-5PF 200VDC CER	28480	0160-3874
A14A2C8	0160-3874	2		CAPACITOR-FXD 10PF +-5PF 200VDC CER	28480	0160-3874
A14A2C9	0160-4385	2		CAPACITOR-FXD 15PF +-5% 200VDC CER 0+-30	28480	0160-4385
A14A2C10	0160-3879	7		CAPACITOR-FXD .01UF +-20% 100VDC CER	28480	0160-3879
A14A2C11	0160-3879	7		CAPACITOR-FXD .01UF +-20% 100VDC CER	28480	0160-3879
A14A2C12	0160-5971	4		CAPACITOR-FXD 4.7PF +-5PF 50VDC CER	28480	0160-5971
A14A2C13	0160-3879	7		CAPACITOR-FXD .01UF +-20% 100VDC CER	28480	0160-3879
A14A2C14	0160-5971	4		CAPACITOR-FXD 4.7PF +-5PF 50VDC CER	28480	0160-5971
A14A2C15	0160-3879	7		CAPACITOR-FXD .01UF +-20% 100VDC CER	28480	0160-3879
A14A2C16	0160-4389	6		CAPACITOR-FXD 100PF +-5PF 200VDC CER	28480	0160-4389
A14A2C17	0160-3875	3		CAPACITOR-FXD 22PF +-5% 200VDC CER 0+-30	28480	0160-3875
A14A2C18	0160-3875	3		CAPACITOR-FXD 22PF +-5% 200VDC CER 0+-30	28480	0160-3875
A14A2C19	0160-3879	7		CAPACITOR-FXD .01UF +-20% 100VDC CER	28480	0160-3879
A14A2C20	0160-3879	7		CAPACITOR-FXD .01UF +-20% 100VDC CER	28480	0160-3879
A14A2C21	0160-4441	1	3	CAPACITOR-FXD .47UF +-10% 50VDC CER	28480	0160-4441
A14A2C22	0160-0573	2		CAPACITOR-FXD 4700PF +-20% 100VDC CER	28480	0160-0573
A14A2C23	0160-3875	3		CAPACITOR-FXD 22PF +-5% 200VDC CER 0+-30	28480	0160-3875
A14A2C24	0160-3879	7		CAPACITOR-FXD .01UF +-20% 100VDC CER	28480	0160-3879
A14A2C25	0160-3879	7		CAPACITOR-FXD .01UF +-20% 100VDC CER	28480	0160-3879
A14A2C26				NOT ASSIGNED		
A14A2C27	0160-4441	1		CAPACITOR-FXD .47UF +-10% 50VDC CER	28480	0160-4441
A14A2C28	0160-3879	7		CAPACITOR-FXD .01UF +-20% 100VDC CER	28480	0160-3879
A14A2C29	0160-3879	7		CAPACITOR-FXD .01UF +-20% 100VDC CER	28480	0160-3879
A14A2C30				NOT ASSIGNED		
A14A2C31	0160-3879	7		CAPACITOR-FXD .01UF +-20% 100VDC CER	28480	0160-3879
A14A2C32	0160-3879	7		CAPACITOR-FXD .01UF +-20% 100VDC CER	28480	0160-3879
A14A2C33	0160-5957	6		CAPACITOR-FXD 47PF +-5% 50VDC CER 0+-30	28480	0160-5957
A14A2C34	0160-5957	6		CAPACITOR-FXD 47PF +-5% 50VDC CER 0+-30	28480	0160-5957
A14A2C35	0160-5957	6		CAPACITOR-FXD 47PF +-5% 50VDC CER 0+-30	28480	0160-5957
A14A2C36	0160-3875	3		CAPACITOR-FXD 22PF +-5% 200VDC CER 0+-30	28480	0160-3875
A14A2C37	0160-3875	3		CAPACITOR-FXD 22PF +-5% 200VDC CER 0+-30	28480	0160-3875
A14A2C38	0160-3879	7		CAPACITOR-FXD .01UF +-20% 100VDC CER	28480	0160-3879
A14A2C39	0160-4389	6		CAPACITOR-FXD 100PF +-5PF 200VDC CER	28480	0160-4389
A14A2C40	0160-4389	6		CAPACITOR-FXD 100PF +-5PF 200VDC CER	28480	0160-4389
A14A2C41	0160-3879	7		CAPACITOR-FXD .01UF +-20% 100VDC CER	28480	0160-3879
A14A2C42				NOT ASSIGNED		
A14A2C43	0160-5971	4		CAPACITOR-FXD 4.7PF +-5PF 50VDC CER	28480	0160-5971
A14A2C44	0160-3879	7		CAPACITOR-FXD .01UF +-20% 100VDC CER	28480	0160-3879
A14A2C45	0160-5971	4		CAPACITOR-FXD 4.7PF +-5PF 50VDC CER	28480	0160-5971
A14A2C46	0160-3879	7		CAPACITOR-FXD .01UF +-20% 100VDC CER	28480	0160-3879
A14A2C47	0160-5971	4		CAPACITOR-FXD 4.7PF +-5PF 50VDC CER	28480	0160-5971
A14A2C48	0160-3879	7		CAPACITOR-FXD .01UF +-20% 100VDC CER	28480	0160-3879
A14A2C49	0160-3879	7		CAPACITOR-FXD .01UF +-20% 100VDC CER	28480	0160-3879
A14A2C50	0160-5971	4		CAPACITOR-FXD 4.7PF +-5PF 50VDC CER	28480	0160-5971

See introduction to this section for ordering information.

\* Indicates factory selected value

Table 6-2. Replaceable Parts

Reference Designation	HP Part Number	C D	Qty	Description	Mfr Code	Mfr Part Number
A14A2C51	0160-3879	7		CAPACITOR-FXD .01UF +-20% 100VDC CER	28480	0160-3879
A14A2C52	0160-3879	7		CAPACITOR-FXD .01UF +-20% 100VDC CER	28480	0160-3879
A14A2C53				NOT ASSIGNED		
A14A2C54	0160-5978	1		CAPACITOR-FXD 2.2F 50VDC CER	28480	0160-5978
A14A2C55	0160-4521	8		CAPACITOR-FXD 12PF +-5% 200VDC CER 0+-30	28480	0160-4521
A14A2C56				NOT ASSIGNED		
A14A2C57	0160-3879	7		CAPACITOR-FXD .01UF +-20% 100VDC CER	28480	0160-3879
A14A2C58	0160-3879	7		CAPACITOR-FXD .01UF +-20% 100VDC CER	28480	0160-3879
A14A2C59	0160-3879	7		CAPACITOR-FXD .01UF +-20% 100VDC CER	28480	0160-3879
A14A2C60				NOT ASSIGNED		
A14A2C61	0160-3879	7		CAPACITOR-FXD .01UF +-20% 100VDC CER	28480	0160-3879
A14A2C62	0160-3879	7		CAPACITOR-FXD .01UF +-20% 100VDC CER	28480	0160-3879
A14A2C63	0160-3879	7		CAPACITOR-FXD .01UF +-20% 100VDC CER	28480	0160-3879
A14A2C64				NOT ASSIGNED		
A14A2C65	0160-3879	7		CAPACITOR-FXD .01UF +-20% 100VDC CER	28480	0160-3879
A14A2C66	0160-3879	7		CAPACITOR-FXD .01UF +-20% 100VDC CER	28480	0160-3879
A14A2C67	0160-5978	1		CAPACITOR-FXD 2.2PF 50VDC CER	28480	0160-5978
A14A2C68	0160-5957	6		CAPACITOR-FXD 47PF +-5% 50VDC CER 0+-30	28480	0160-5957
A14A2C69	0160-3879	7		CAPACITOR-FXD .01UF +-20% 100VDC CER	28480	0160-3879
A14A2C70	0160-5957	6		CAPACITOR-FXD 47PF +-5% 50VDC CER 0+-30	28480	0160-5957
A14A2C71	0160-5975	8		CAPACITOR-FXD 10PF +-5% 50VDC CER 0+-30	28480	0160-5975
A14A2C72	0160-3879	7		CAPACITOR-FXD .01UF +-20% 100VDC CER	28480	0160-3879
A14A2C73	0160-5945	2		CAPACITOR-FXD .01UF +-10% 50VDC CER	28480	0160-5945
A14A2C74	0160-3879	7		CAPACITOR-FXD .01UF +-20% 100VDC CER	28480	0160-3879
A14A2C75	0160-3879	7		CAPACITOR-FXD .01UF +-20% 100VDC CER	28480	0160-3879
A14A2C76	0160-3879	7		CAPACITOR-FXD .01UF +-20% 100VDC CER	28480	0160-3879
A14A2C77	0160-3879	7		CAPACITOR-FXD .01UF +-20% 100VDC CER	28480	0160-3879
A14A2C78	0160-3879	7		CAPACITOR-FXD .01UF +-20% 100VDC CER	28480	0160-3879
A14A2C79	0160-3873	1		CAPACITOR-FXD 4.7PF +-5% 200VDC CER	28480	0160-3873
A14A2C80	0160-3875	3		CAPACITOR-FXD 22PF +-5% 200VDC CER 0+-30	28480	0160-3875
A14A2C81	0160-3879	7		CAPACITOR-FXD .01UF +-20% 100VDC CER	28480	0160-3879
A14A2C82	0160-4493	3		CAPACITOR-FXD 27PF +-5% 200VDC CER 0+-30	28480	0160-4493
A14A2C83	0160-3879	7		CAPACITOR-FXD .01UF +-20% 100VDC CER	28480	0160-3879
A14A2C84	0160-5957	6		CAPACITOR-FXD 47PF +-5% 50VDC CER 0+-30	28480	0160-5957
A14A2C85	0160-5975	8		CAPACITOR-FXD 10PF +-5% 50VDC CER 0+-30	28480	0160-5975
A14A2C86	0160-0576	5		CAPACITOR-FXD .1UF +-20% 50VDC CER	28480	0160-0576
A14A2C87	0160-0576	5		CAPACITOR-FXD .1UF +-20% 50VDC CER	28480	0160-0576
2427A TO 2521A A14A2C88	0160-5945	2		CAPACITOR-FXD .01UF +-10% 50VDC CER	28480	0160-5945
A14A2C89	0160-5945	2		CAPACITOR-FXD .01UF +-10% 50VDC CER	28480	0160-5945
A14A2C90	0160-5945	2		CAPACITOR-FXD .01UF +-10% 50VDC CER	28480	0160-5945
2526A AND ABOVE						
A14A2C88	0160-6222	0		CAPACITOR-FXD .1U 50 VDC CER	28480	0160-6222
A14A2C89	0160-6222	0		CAPACITOR-FXD .1U 50 VDC CER	28480	0160-6222
A14A2C90	0160-6222	0		CAPACITOR-FXD .1U 50 VDC CER	28480	0160-6222
A14A2C91	0180-2661	5		CAPACITOR-FXD 1UF+-10% 50VDC TA	25088	D1R0GS1A50K
2427A TO 2521A A14A2C92	0160-5945	2		CAPACITOR-FXD .01UF +-10% 50VDC CER	28480	0160-5945
2526A AND ABOVE A14A2C92	0160-6222	0		CAPACITOR-FXD .1U 50 VDC CER	28480	0160-6222
2427A TO 2507A A14A2C93	0160-4877	7		CAPACITOR-FXD 3.9PF +- .25PF 50VDC CER	28480	0160-4877
2509A TO 2521A A14A2C93				NOT ASSIGNED		
2526A AND ABOVE A14A2C93	0160-6222	0		CAPACITOR-FXD .1U 50 VDC CER	28480	0160-6222
2427A TO 2521A A14A2C94				NOT ASSIGNED		
2526A AND ABOVE A14A2C94	0160-6222	0		CAPACITOR-FXD .1U 50 VDC CER	28480	0160-6222

See introduction to this section for ordering information.

\* Indicates factory selected value

Table 6-2. Replaceable Parts

Reference Designation	HP Part Number	C D	Qty	Description	Mfr Code	Mfr Part Number
A14A2CR1	1901-0457	4		DIODE-STEP RECOVERY	28480	1901-0457
A14A2CR2	1906-0098	9		DIODE-MATCHED 1V	28480	1906-0098
A14A2CR3	1906-0098	9		DIODE-MATCHED 1V	28480	1906-0098
A14A2CR4	1906-0098	9		DIODE-MATCHED 1V	28480	1906-0098
A14A2CR5	1906-0098	9		DIODE-MATCHED 1V	28480	1906-0098
A14A2CR6				NOT ASSIGNED		
A14A2CR7				NOT ASSIGNED		
A14A2CR8	1901-0518	8		DIODE-SM SIG SCHOTTKY	28480	1901-0518
A14A2CR9	1901-0518	8		DIODE-SM SIG SCHOTTKY	28480	1901-0518
A14A2CR10				NOT ASSIGNED		
A14A2CR11	0122-0161	4	2	DVVC 2.2PF 5.0CR	28480	0122-0161
A14A2CR12	0122-0161	4		DVVC 2.2PF 5.0CR	28480	0122-0161
A14A2CR13	1901-1134	6	2	DIODE PIN	28480	1901-1134
A14A2CR14	1901-1134	6		DIODE PIN	28480	1901-1134
A14A2CR15	1901-0050	3		DIODE-SWITCHING 80V 200MA 2NS DO-35	28480	1901-0050
A14A2CR16-CR23				NOT ASSIGNED		
A14A2CR24	1901-0050	3		DIODE-SWITCHING 80V 200MA 2NS DO-35	28480	1901-0050
A14A2CR25	1901-0050	3		DIODE-SWITCHING 80V 200MA 2NS DO-35	28480	1901-0050
A14A2FL1	9135-0214	4		FILTER-HIGH PASS PIN STYLE-TERMS	28480	9135-0214
A14A2FL2	9135-0214	4		FILTER-HIGH PASS PIN STYLE-TERMS	28480	9135-0214
A14A2FL3	9135-0214	4		FILTER-HIGH PASS PIN STYLE-TERMS	28480	9135-0214
A14A2FL4	9135-0214	4		FILTER-HIGH PASS PIN STYLE-TERMS	28480	9135-0214
A14A2FL5	9135-0214	4		FILTER-HIGH PASS PIN STYLE-TERMS	28480	9135-0214
A14A2FL6	9135-0214	4		FILTER-HIGH PASS PIN STYLE-TERMS	28480	9135-0214
A14A2FL7	9135-0214	4		FILTER-HIGH PASS PIN STYLE-TERMS	28480	9135-0214
A14A2J1	1250-2090	4		CONNECTOR-RF SMC M SGL-HOLE-RR 50-OHM	28480	1250-2090
	08642-20081	7		ELSTMR COND SMC	28480	08642-20081
A14A2J2	1251-8105	6		CONN-POST TYPE .100-PIN-SPCG 16-CONT	28480	1251-8105
	1251-5595	2		POLARIZING KEY-POST CONN	28480	1251-5595
A14A2J3	1251-8758	5		CONN-POST TYPE .100-PIN-SPCG 8-CONT	28480	1251-8758
A14A2J4	1250-2090	4		CONNECTOR-RF SMC M SGL-HOLE-RR 50-OHM	28480	1250-2090
	08642-20081	7		ELSTMR COND SMC	28480	08642-20081
A14A2L1				NOT ASSIGNED		
<i>2427A TO 2714A</i>						
<i>A14A2L2</i>	9100-2254	3		INDUCTOR RF-CH-MLD 390NH 10% .105DX.26LG	28480	9100-2254
<i>2731A ONLY</i>						
<i>A14A2L2</i>	9140-0353	3		INDUCTOR RF-CH-MLD 430NH 1% .105DX.26LG	28480	9140-0353
<i>2744A AND ABOVE</i>						
<i>A14A2L2</i>	9140-0477	2		INDUCTOR RF-CH-MLD 270NH 1% .105DX.26LG	28480	9140-0477
A14A2L3				NOT ASSIGNED		
A14A2L4				NOT ASSIGNED		
A14A2L5	9100-2251	0		INDUCTOR RF-CH-MLD 220NH 10% .105DX.26LG	28480	9100-2251
A14A2L6	9100-2251	0		INDUCTOR RF-CH-MLD 220NH 10% .105DX.26LG	28480	9100-2251
A14A2L7	9140-0210	1		INDUCTOR RF-CH-MLD 100UH 5% .166DX.385LG	28480	9140-0210
A14A2L8	9100-2247	4		INDUCTOR RF-CH-MLD 100NH 10% .105DX.26LG	28480	9100-2247
A14A2L9	9100-2247	4		INDUCTOR RF-CH-MLD 100NH 10% .105DX.26LG	28480	9100-2247
A14A2L10	9140-1087	2		INDUCTOR-FIXED 120-1300 HZ	28480	9140-1087
A14A2L11	9140-1087	2		INDUCTOR-FIXED 120-1300 HZ	28480	9140-1087
A14A2L12	9100-2251	0		INDUCTOR RF-CH-MLD 220NH 10% .105DX.26LG	28480	9100-2251
A14A2L13	9100-2251	0		INDUCTOR RF-CH-MLD 220NH 10% .105DX.26LG	28480	9100-2251
A14A2L14	9100-2247	4		INDUCTOR RF-CH-MLD 100NH 10% .105DX.26LG	28480	9100-2247
A14A2L15	9140-0531	9		INDUCTOR RF-CH-MLD 1UH 5% .105DX.26LG	28480	9140-0531
<i>2447A TO 2521A</i>						
<i>A14A2L16</i>	9100-3922	4		INDUCTOR-FIXED 120-1300 HZ	28480	9100-3922
<i>2526A AND ABOVE</i>						
<i>A14A2L16</i>				NOT ASSIGNED		
A14A2L17	9140-1087	2		INDUCTOR-FIXED 120-1300 HZ	28480	9140-1087
A14A2L18	9140-1087	2		INDUCTOR-FIXED 120-1300 HZ	28480	9140-1087
A14A2L19	9140-0144	0		INDUCTOR RF-CH-MLD 4.7UH 10% .105DX.26LG	28480	9140-0144
A14A2L20	9140-1087	2		INDUCTOR-FIXED 120-1300 HZ	28480	9140-1087
A14A2L21	9140-1087	2		INDUCTOR-FIXED 120-1300 HZ	28480	9140-1087
A14A2L22	9140-1087	2		INDUCTOR-FIXED 120-1300 HZ	28480	9140-1087
A14A2L23	9140-1087	2		INDUCTOR-FIXED 120-1300 HZ	28480	9140-1087
A14A2L24	9140-1087	2		INDUCTOR-FIXED 120-1300 HZ	28480	9140-1087
A14A2L25	9140-1087	2		INDUCTOR-FIXED 120-1300 HZ	28480	9140-1087

See introduction to this section for ordering information.

\* Indicates factory selected value

Table 6-2. Replaceable Parts

Reference Designation	HP Part Number	C D	Qty	Description	Mfr Code	Mfr Part Number
A14A2L26	9140-1087	2		INDUCTOR-FIXED 120-1300 HZ	28480	9140-1087
A14A2L27	9140-1087	2		INDUCTOR-FIXED 120-1300 HZ	28480	9140-1087
A14A2L28	9140-1087	2		INDUCTOR-FIXED 120-1300 HZ	28480	9140-1087
A14A2L29	9140-1087	2		INDUCTOR-FIXED 120-1300 HZ	28480	9140-1087
A14A2L30	9140-1087	2		INDUCTOR-FIXED 120-1300 HZ	28480	9140-1087
A14A2L31	9140-1087	2		INDUCTOR-FIXED 120-1300 HZ	28480	9140-1087
A14A2L32	9140-1087	2		INDUCTOR-FIXED 120-1300 HZ	28480	9140-1087
A14A2L33	9140-1087	2		INDUCTOR-FIXED 120-1300 HZ	28480	9140-1087
A14A2L34	9140-1087	2		INDUCTOR-FIXED 120-1300 HZ	28480	9140-1087
A14A2L35	9140-1087	2		INDUCTOR-FIXED 120-1300 HZ	28480	9140-1087
2447A TO 2521A A14A2L36	9100-3548	0	2	INDUCTOR RF-CH-MLD 470NH 5% .166DX.385LG	28480	9100-3548
2526A AND ABOVE A14A2L36	9100-0593	9		INDUCTOR-RF-CH-MLD 470NH 5% .105DX.26LG	28480	9100-0593
A14A2MP1	5021-3273	6	7	CABLE HOLDER	28480	5021-3273
A14A2MP2	0340-0840	8		INSULATOR SLBL-LAC-CMPD	28480	0340-0840
A14A2Q1	1854-0946	5		TRANSISTOR NPN SI PD=290MW	28480	1854-0946
A14A2Q2	1854-0946	5		TRANSISTOR NPN SI PD=290MW	28480	1854-0946
A14A2Q3	1853-0264	8	1	TRANSISTOR NPN SI PD=310MW FT=100MHZ	04713	2N5401
A14A2Q4	1854-0946	5		TRANSISTOR NPN SI PD=290MW	28480	1854-0946
A14A2Q5	1854-1008	2		TRANSISTOR NPN SI PD=600MW FT=2GHZ	28480	1854-1008
A14A2Q6	1854-0946	5		TRANSISTOR NPN SI PD=290MW	28480	1854-0946
A14A2Q7	1854-0946	5		TRANSISTOR NPN SI PD=290MW	28480	1854-0946
A14A2Q8	1854-0946	5		TRANSISTOR NPN SI PD=290MW	28480	1854-0946
A14A2Q9	1854-0946	5		TRANSISTOR NPN SI PD=290MW	28480	1854-0946
A14A2Q10	1854-0946	5		TRANSISTOR NPN SI PD=290MW	28480	1854-0946
A14A2Q11				NOT ASSIGNED		
A14A2Q12	1854-0946	5		TRANSISTOR NPN SI PD=290MW	28480	1854-0946
A14A2Q13	1854-1036	6	2	TRANSISTOR NPN SI PD=2.5W	28480	1854-1036
A14A2R1	0698-7205	0		RESISTOR 51.1 1% .05W F TC=0+-100	24546	C3-1/8-T0-51R1-F
A14A2R2	0698-7236	7		RESISTOR 1K 1% .05W F TC=0+-100	24546	C3-1/8-T0-1001-F
2427A TO 2521A A14A2R3	0698-0090	7		RESISTOR 464 1% .5W F TC=0+-100	28480	0698-0090
2526A AND ABOVE A14A2R3	0757-1092	7		RESISTOR 287 1% .5W F TC=0+-100	28480	0757-1092
A14A2R4	0698-7212	9		RESISTOR 100 1% .05W F TC=0+-100	24546	C3-1/8-T0-100R-F
A14A2R5	0698-7272	1		RESISTOR 31.6K 1% .05W F TC=0+-100	24546	C3-1/8-T0-3162-F
A14A2R6	0757-0416	7		RESISTOR 511 1% .125W F TC=0+-100	24546	C4-1/8-T0-511R-F
A14A2R7	0699-1241	4		RESISTOR 1.47K 1% .2W C TC=0+-200	28480	0699-1241
A14A2R8	0698-7200	5	2	RESISTOR 31.6 1% .05W F TC=0+-100	24546	C3-1/8-T0-316R-F
A14A2R9	0757-0419	0		RESISTOR 681 1% .125W F TC=0+-100	24546	C4-1/8-T0-681R-F
A14A2R10	0699-1241	4		RESISTOR 1.47K 1% .2W C TC=0+-200	28480	0699-1241
A14A2R11	0698-7212	9		RESISTOR 100 1% .05W F TC=0+-100	24546	C3-1/8-T0-100R-F
A14A2R12	0698-3446	3		RESISTOR 383 1% .125W F TC=0+-100	24546	C4-1/8-T0-383R-F
A14A2R13	0698-3440	7		RESISTOR 196 1% .125W F TC=0+-100	24546	C4-1/8-T0-196R-F
A14A2R14	0698-7269	6	1	RESISTOR 23.7K 1% .05W F TC=0+-100	24546	C3-1/8-T0-2372-F
A14A2R15	0698-3456	5	2	RESISTOR 287K 1% .125W F TC=0+-100	24546	C4-1/8-T0-2873-F
A14A2R16	0757-0417	8		RESISTOR 562 1% .125W F TC=0+-100	24546	C4-1/8-T0-562R-F
A14A2R17	0698-7254	9		RESISTOR 5.62K 1% .05W F TC=0+-100	24546	C3-1/8-T0-5621-F
A14A2R18	0698-3260	9		RESISTOR 464K 1% .125W F TC=0+-100	28480	0698-3260
A14A2R19	0698-7246	9		RESISTOR 2.61K 1% .05W F TC=0+-100	24546	C3-1/8-T0-2611-F
A14A2R20	0698-7211	8		RESISTOR 90.9 1% .05W F TC=0+-100	24546	C3-1/8-T0-909R-F
A14A2R21	0757-0438	3		RESISTOR 5.11K 1% .125W F TC=0+-100	24546	C4-1/8-T0-5111-F
A14A2R22	0757-0280	3		RESISTOR 1K 1% .125W F TC=0+-100	24546	C4-1/8-T0-1001-F
A14A2R23				NOT ASSIGNED		
2427A TO 2642A A14A2R24	0698-7268	5		RESISTOR 21.5K 1% .05W F TC=0+-100	24546	C3-1/8-T0-2152-F
2714A AND ABOVE A14A2R24	0698-7271	0		RESISTOR 28.7K 1% .05W F TC=0+-100	24546	C3-1/8-T0-2872-F
A14A2R25	0698-7272	1		RESISTOR 31.6K 1% .05W F TC=0+-100	24546	C3-1/8-T0-3162-F
A14A2R26	0698-7282	3		RESISTOR 82.5K 1% .05W F TC=0+-100	24546	C3-1/8-T0-8252-F
A14A2R27	0698-7252	7		RESISTOR 4.64K 1% .05W F TC=0+-100	24546	C3-1/8-T0-4641-F
A14A2R28	0698-7282	3		RESISTOR 82.5K 1% .05W F TC=0+-100	24546	C3-1/8-T0-8252-F
A14A2R29	0698-7252	7		RESISTOR 4.64K 1% .05W F TC=0+-100	24546	C3-1/8-T0-4641-F
A14A2R30	0698-8615	8		RESISTOR 75K 1% .05W F TC=0+-100	28480	0698-8615

See introduction to this section for ordering information.

\* Indicates factory selected value

Table 6-2. Replaceable Parts

Reference Designation	HP Part Number	C D	Qty	Description	Mfr Code	Mfr Part Number
A14A2R31	0698-7236	7		RESISTOR 1K 1% .05W F TC=0+-100	24546	C3-1/8-T0-1001-F
2427A TO 2521A A14A2R32	0698-3157	3		RESISTOR 19.6K 1% .125W F TC=0+-100	24546	C4-1/8-T0-1962-F
2526A AND ABOVE A14A2R32	0757-0747	7		RESISTOR 5.11K 1% .25W F TC=0+-100	24546	C4-1/8-T0-5111-
A14A2R33	0698-7236	7		RESISTOR 1K 1% .05W F TC=0+-100	24546	C3-1/8-T0-1001-F
A14A2R34	0698-3447	4		RESISTOR 422 1% .125W F TC=0+-100	24546	C4-1/8-T0-422R-F
A14A2R35	0699-1241	4		RESISTOR 1.47K 1% .2W C TC=0+-200	28480	0699-1241
A14A2R36	0698-1391	5		RESISTOR 10K 1% .125W F TC=0+-100	28480	0699-1391
A14A2R37	0698-7243	6		RESISTOR 1.96K 1% .05W F TC=0+-100	24546	C3-1/8-T0-1961-F
A14A2R38	0698-7253	8		RESISTOR 5.11K 1% .05W F TC=0+-100	24546	C3-1/8-T0-5111-F
A14A2R39	0757-0416	7		RESISTOR 511 1% .125W F TC=0+-100	24546	C4-1/8-T0-511R-F
A14A2R40	0757-0279	0		RESISTOR 3.16K 1% .125W F TC=0+-100	24546	C4-1/8-T0-3161-F
A14A2R41	0757-0280	3		RESISTOR 1K 1% .125W F TC=0+-100	24546	C4-1/8-T0-1001-F
A14A2R42	0698-7203	8		RESISTOR 42.2 1% .05W F TC=0+-100	24546	C3-1/8-T0-42R2-F
A14A2R43	0757-0428	1		RESISTOR 1.62K 1% .125W F TC=0+-100	24546	C4-1/8-T0-1621-F
2447A TO 2521A A14A2R44	0699-1241	4		RESISTOR 1.47K 1% .2W C TC=0+-200	28480	0699-1241
2526A AND ABOVE A14A2R44	0699-1423	4		RESISTOR 215 1% .125W F TC=0+-100	28480	0699-1423
A14A2R45	0757-0419	0		RESISTOR 681 1% .125W F TC=0+-100	24546	C4-1/8-T0-681R-F
A14A2R46	0699-1966	0		RESISTOR 90.1 1% .05W	28480	0699-1966
A14A2R47	0699-1423	4		RESISTOR 215 1% .125W F TC=0+-100	28480	0699-1423
A14A2R48	0757-0419	0		RESISTOR 681 1% .125W F TC=0+-100	24546	C4-1/8-T0-681R-F
A14A2R49	0699-1969	3		RESISTOR 26.1 1% .05W	28480	0699-1969
A14A2R50	0698-7212	9		RESISTOR 100 1% .05W F TC=0+-100	24546	C3-1/8-T0-100R-F
A14A2R51	0699-1241	4		RESISTOR 1.47K 1% .2W C TC=0+-200	28480	0699-1241
A14A2R52	0757-0419	0		RESISTOR 681 1% .125W F TC=0+-100	24546	C4-1/8-T0-681R-F
A14A2R53	0698-7212	9		RESISTOR 100 1% .05W F TC=0+-100	24546	C3-1/8-T0-100R-F
A14A2R54	0699-1241	4		RESISTOR 1.47K 1% .2W C TC=0+-200	28480	0699-1241
A14A2R55	0757-0419	0		RESISTOR 681 1% .125W F TC=0+-100	24546	C4-1/8-T0-681R-F
A14A2R56	0698-7203	8		RESISTOR 42.2 1% .05W F TC=0+-100	24546	C3-1/8-T0-42R2-F
A14A2R57	0699-1423	4		RESISTOR 215 1% .125W F TC=0+-100	28480	0699-1423
A14A2R58	0757-0419	0		RESISTOR 681 1% .125W F TC=0+-100	24546	C4-1/8-T0-681R-F
A14A2R59	0698-7203	8		RESISTOR 42.2 1% .05W F TC=0+-100	24546	C3-1/8-T0-42R2-F
A14A2R60				NOT ASSIGNED		
A14A2R61	0699-1423	4		RESISTOR 215 1% .125W F TC=0+-100	28480	0699-1423
A14A2R62	0698-3447	4		RESISTOR 422 1% .125W F TC=0+-100	24546	C4-1/8-T0-422R-F
A14A2R63				NOT ASSIGNED		
A14A2R64				NOT ASSIGNED		
A14A2R65	0698-7260	7		RESISTOR 10K 1% .05W F TC=0+-100	24546	C3-1/8-T0-1002-F
A14A2R66				NOT ASSIGNED		
A14A2R67				NOT ASSIGNED		
A14A2R68	0698-7260	7		RESISTOR 10K 1% .05W F TC=0+-100	24546	C3-1/8-T0-1002-F
A14A2R69				NOT ASSIGNED		
A14A2R70	0698-7275	4	3	RESISTOR 42.2K 1% .05W F TC=0+-100	24546	C3-1/8-T0-4222-F
A14A2R71	0698-7252	7		RESISTOR 4.64K 1% .05W F TC=0+-100	24546	C3-1/8-T0-4641-F
A14A2R72	0699-1423	4		RESISTOR 215 1% .125W F TC=0+-100	28480	0699-1423
A14A2R73	0699-1350	6		RESISTOR 17.8 1% .125W F TC=0+-100	28480	0699-1350
A14A2R74	0699-1350	6		RESISTOR 17.8 1% .125W F TC=0+-100	28480	0699-1350
A14A2R75				NOT ASSIGNED		
A14A2R76				NOT ASSIGNED		
A14A2R77	0757-1090	5		RESISTOR 261 1% .5W F TC=0+-100	28480	0757-1090
A14A2R78	0699-1423	4		RESISTOR 215 1% .125W F TC=0+-100	28480	0699-1423
A14A2R79	0699-1346	0		RESISTOR 12.1 1% .125W F TC=0+-100	28480	0699-1346
A14A2R80	0699-1346	0		RESISTOR 12.1 1% .125W F TC=0+-100	28480	0699-1346
A14A2R81				NOT ASSIGNED		
A14A2R82				NOT ASSIGNED		
A14A2R83	0698-3399	5		RESISTOR 133 1% .5W F TC=0+-100	28480	0698-3399
A14A2R84	0698-7219	6		RESISTOR 196 1% .05W F TC=0+-100	24546	C3-1/8-T0-196R-F
A14A2R85	0698-7253	8		RESISTOR 5.11K 1% .05W F TC=0+-100	24546	C3-1/8-T0-5111-F
A14A2R86	0698-7221	0		RESISTOR 237 1% .05W F TC=0+-100	24546	C3-1/8-T0-237R-F
A14A2R87				NOT ASSIGNED		
A14A2R88				NOT ASSIGNED		
A14A2R89	0698-7236	7		RESISTOR 1K 1% .05W F TC=0+-100	24546	C3-1/8-T0-1001-F
A14A2R90	0698-7258	3		RESISTOR 8.25K 1% .05W F TC=0+-100	24546	C3-1/8-T0-8251-F

See introduction to this section for ordering information.

\* Indicates factory selected value

Table 6-2. Replaceable Parts

Reference Designation	HP Part Number	C D	Qty	Description	Mfr Code	Mfr Part Number
R14A2R91	0698-7284	5		RESISTOR 100K 1% .05W F TC=0+-100	24546	C3-1/8-T0-1003-F
2427A TO 2513A A14A2R92 2514A AND ABOVE A14A2R92	0698-8827	4		NOT ASSIGNED RESISTOR 1M 1% .125W F TC=0+-100	28480	0698-8827
2427A TO 2521A A14A2R93-R98 2526A AND ABOVE				NOT ASSIGNED		
A14A2R93	0699-1372	2		RESISTOR 1.47K 1% .125W F TC=0+-100	28480	0699-1372
A14A2R94	0699-1372	2		RESISTOR 1.47K 1% .125W F TC=0+-100	28480	0699-1372
A14A2R95	0699-1372	2		RESISTOR 1.47K 1% .125W F TC=0+-100	28480	0699-1372
A14A2R96	0699-1432	5		RESISTOR 511 1% .125W F TC=0+-100	28480	0699-1432
A14A2R97	0699-0182	0		RESISTOR 220 5% .1W C TC=0+-200	28480	0699-0182
A14A2R98	0699-1372	2		RESISTOR 1.47K 1% .125W F TC=0+-100	28480	0699-1372
R14A2TP1	0360-0535	0		TERMINAL TEST POINT PCB	00000	ORDER BY DESCRIPTION
R14A2TP2	0360-0535	0		TERMINAL TEST POINT PCB	00000	ORDER BY DESCRIPTION
R14A2TP3	1251-4670	2	2	CONNECTOR 3-PIN M POST TYPE	28480	1251-4670
R14A2TP4	0360-0535	0		TERMINAL TEST POINT PCB	00000	ORDER BY DESCRIPTION
R14A2U1	1820-2684	1		IC GATE TTL F NAND QUAD 2-INP	07263	74F00PC
R14A2U2	1820-2691	0		IC FF TTL F D-TYPE POS-EDGE-TRIG	07263	74F74PC
R14A2U3	1826-0371	1		IC OP AMP LOW-BIAS-H-IMPD T0-99 PKG	27014	LF256H
R14A2U4	1826-1796	6		IC OP AMP LOW-BIAS-H-IMPD DUAL 8-DIP-C	28480	1826-1796
R14A2U5	1826-0606	5		IC SWITCH ANLG QUAD 16-DIP-C PKG	17856	DG201BK
2427A TO 2744A A14A2U6	1826-0759	9		IC COMPARATOR GP QUAD 14-DIP-C PKG 04713	LM339J	
2807A AND ABOVE A14A2U6	1826-0138	8		IC COMPARATOR GP QUAD 14-DIP-C PKG	01295	LM339N
R14A2U7	1820-1423	4		IC MV TTL LS MONOSTBL RETRIG DUAL	01295	SN74LS123N
R14A2U8	1826-0605	4		IC MULTIPLXR 8-CHAN-ANLG 16-DIP-C PKG	17856	DG508BK
R14A2U9				NOT ASSIGNED		
R14A2U10	08642-80061	9		IC DRVR TTL AND DUAL 2-INP	28480	08642-80061
R14A2VR1	1902-1428	3		DIODE-ZNR 4.6V DO-35 PD=.4W IR=1UA	28480	1902-1428
R14A2VR2	1902-1428	3		DIODE-ZNR 4.6V DO-35 PD=.4W IR=1UA	28480	1902-1428
R14A2VR3	1902-1428	3		DIODE-ZNR 4.6V DO-35 PD=.4W IR=1UA	28480	1902-1428
R14A2VR4	1902-1428	3		DIODE-ZNR 4.6V DO-35 PD=.4W IR=1UA	28480	1902-1428
R14A2VR5	1902-1428	3		DIODE-ZNR 4.6V DO-35 PD=.4W IR=1UA	28480	1902-1428
R14A2VR6	1902-1428	3		DIODE-ZNR 4.6V DO-35 PD=.4W IR=1UA	28480	1902-1428
R14A2VR7	1902-1428	3		DIODE-ZNR 4.6V DO-35 PD=.4W IR=1UA	28480	1902-1428
R14A2VR8	1902-1428	3		DIODE-ZNR 4.6V DO-35 PD=.4W IR=1UA	28480	1902-1428
R14A2VR9	1902-1428	3		DIODE-ZNR 4.6V DO-35 PD=.4W IR=1UA	28480	1902-1428
R14A2VR10	1902-1428	3		DIODE-ZNR 4.6V DO-35 PD=.4W IR=1UA	28480	1902-1428
R14A2VR11	1902-1428	3		DIODE-ZNR 4.6V DO-35 PD=.4W IR=1UA	28480	1902-1428
2427A TO 2521A A14A2VR12 2526A AND ABOVE A15A2VR12	1902-1428	3		NOT ASSIGNED DIODE-ZNR 4.6V DO-35 PD=.4W IR=1UA	28480	1902-1428
R14A2W1	1258-0209	9		JUMPER-REMOVABLE 2 POSITION; .200 IN	28480	1258-0209
R14A2W2	08642-20062	4	1	SEMI-RIGID 50Z	28480	08642-20062
2427A TO 2507A A14A2W3				PART IS ETCHED TRACE ON CIRCUIT BOARD		
2509A AND ABOVE A14A2W3				NOT ASSIGNED		
R14A2W4				PART IS ETCHED TRACE ON CIRCUIT BOARD		
R14A2W5				PART IS ETCHED TRACE ON CIRCUIT BOARD		
R14A2Y1	1GA1-8004	6		SAW CMPNT 832.5	28480	1GA1-8004

See introduction to this section for ordering information.

\* Indicates factory selected value

Table 6-2. Replaceable Parts

Reference Designation	HP Part Number	C D	Qty	Description	Mfr Code	Mfr Part Number
<b>A14A3</b>						
2427A TO 2807A A14A3	08642-60116	3	1	HETERODYNE ASSEMBLY	28480	08642-60116
2825A AND ABOVE A14A3	08642-60216	4	1	HETERODYNE ASSEMBLY	28480	08642-60216
A14A3C1	0160-0576	5		CAPACITOR-FXD .1UF +-20% 50VDC CER	28480	0160-0576
A14A3C2	0180-2620	6		CAPACITOR-FXD 2.2UF+-10% 50VDC TA	25088	D2R2GS1B50K
A14A3C3	0160-4835	7		CAPACITOR-FXD .1UF +-10% 50VDC CER	28480	0160-4835
A14A3C4	0160-4535	4		CAPACITOR-FXD .1UF +-10% 50VDC CER	28480	0160-4535
A14A3C5	0180-0491	5		CAPACITOR-FXD 10UF+-20% 25VDC TA	28480	0180-0491
A14A3C6	0160-0576	5		CAPACITOR-FXD .1UF +-20% 50VDC CER	28480	0160-0576
2427A TO 2807A A14A3C7	0160-3874	2		CAPACITOR-FXD 10PF +- .5PF 200VDC CER	28480	0160-3874
2825A AND ABOVE A14A3C7	0160-4766	3	1	CAPACITOR-FXD 30PF +-5% 200VDC CER 0+-30	28480	0160-4766
A14A3C8	0160-0576	5		CAPACITOR-FXD .1UF +-20% 50VDC CER	28480	0160-0576
A14A3C9	0180-2620	6		CAPACITOR-FXD 2.2UF+-10% 50VDC TA	25088	D2R2GS1B50K
A14A3C10				NOT ASSIGNED		
A14A3C11			2	NOT ASSIGNED		
A14A3C12	0160-3789	8		CAPACITOR-FXD 560PF +-20% 50VDC CER	28480	0160-3789
A14A3C13	0160-4767	4		CAPACITOR-FXD 20PF +-5% 200VDC CER 0+-30	28480	0160-4767
A14A3C14	0160-4768	5		CAPACITOR-FXD 470PF +-5% 100VDC CER	28480	0160-4768
A14A3C15	0160-4768	5		CAPACITOR-FXD 470PF +-5% 100VDC CER	28480	0160-4768
A14A3C16	0160-3789	8		CAPACITOR-FXD 560PF +-20% 50VDC CER	28480	0160-3789
A14A3C17	0160-4767	4		CAPACITOR-FXD 20PF +-5% 200VDC CER 0+-30	28480	0160-4767
A14A3C18				NOT ASSIGNED		
A14A3C19	0160-5961	2		CAPACITOR-FXD 22PF +-5% 50VDC CER 0+-30	28480	0160-5961
A14A3C20	0160-5961	2		CAPACITOR-FXD 22PF +-5% 50VDC CER 0+-30	28480	0160-5961
A14A3C21-C24				NOT ASSIGNED		
2427A TO 2807A A14A3C25	0160-4835	7		CAPACITOR-FXD .1UF +-10% 50VDC CER	28480	0160-4835
A14A3C26	0160-4835	7		CAPACITOR-FXD .1UF +-10% 50VDC CER	28480	0160-4835
2825A AND ABOVE A14A3C25	0160-0576	5		CAPACITOR-FXD .1UF +-20% 50VDC CER	28480	0160-0576
A14A3C26	0160-0576	5		CAPACITOR-FXD .1UF +-20% 50VDC CER	28480	0160-0576
A14A3C27	0160-0576	5		CAPACITOR-FXD .1UF +-20% 50VDC CER	28480	0160-0576
A14A3C28	0160-0576	5		CAPACITOR-FXD .1UF +-20% 50VDC CER	28480	0160-0576
A14A3C29	0180-2620	6		CAPACITOR-FXD 2.2UF+-10% 50VDC TA	25088	D2R2GS1B50K
A14A3C30	0160-0576	5		CAPACITOR-FXD .1UF +-20% 50VDC CER	28480	0160-0576
A14A3C31	0160-0576	5		CAPACITOR-FXD .1UF +-20% 50VDC CER	28480	0160-0576
A14A3C32	0160-4535	4		CAPACITOR-FXD .1UF +-10% 50VDC CER	28480	0160-4535
A14A3C33	0180-0491	5		CAPACITOR-FXD 10UF+-20% 25VDC TA	28480	0180-0491
A14A3C34	0160-0576	5		CAPACITOR-FXD .1UF +-20% 50VDC CER	28480	0160-0576
2427A TO 2807A A14A3C35	0160-4767	4		CAPACITOR-FXD 20PF +-5% 200VDC CER 0+-30	28480	0160-4767
2825A AND ABOVE A14A3C35				NOT ASSIGNED		
A14A3C36	0180-2620	6		CAPACITOR-FXD 2.2UF+-10% 50VDC TA	25088	D2R2GS1B50K
A14A3C37	0160-0576	5		CAPACITOR-FXD .1UF +-20% 50VDC CER	28480	0160-0576
A14A3C38	0160-5961	2		CAPACITOR-FXD 22PF +-5% 50VDC CER 0+-30	28480	0160-5961
A14A3C39	0160-5961	2		CAPACITOR-FXD 22PF +-5% 50VDC CER 0+-30	28480	0160-5961
A14A3C40				NOT ASSIGNED		
A14A3C41				NOT ASSIGNED		
A14A3C42	0160-4835	7		CAPACITOR-FXD .1UF +-10% 50VDC CER	28480	0160-4835
A14A3C43	0160-4535	4		CAPACITOR-FXD .1UF +-10% 50VDC CER	28480	0160-4535
A14A3C44	0160-6222	0		CAPACITOR-FXD .1UF +-10% 50VDC CER	28480	0160-6222
A14A3C45	0180-0491	5		CAPACITOR-FXD 10UF+-20% 25VDC TA	28480	0180-0491
A14A3C46				NOT ASSIGNED		
A14A3C47	0180-2620	6		CAPACITOR-FXD 2.2UF+-10% 50VDC TA	25088	D2R2GS1B50K
A14A3C48	0160-0576	5		CAPACITOR-FXD .1UF +-20% 50VDC CER	28480	0160-0576
A14A3C49	0160-4835	7		CAPACITOR-FXD .1UF +-10% 50VDC CER	28480	0160-4835
A14A3C50	0160-0576	5		CAPACITOR-FXD .1UF +-20% 50VDC CER	28480	0160-0576
A14A3C51	0160-4835	7		CAPACITOR-FXD .1UF +-10% 50VDC CER	28480	0160-4835
A14A3C52	0160-0576	5		CAPACITOR-FXD .1UF +-20% 50VDC CER	28480	0160-0576
A14A3C53	0160-0576	5		CAPACITOR-FXD .1UF +-20% 50VDC CER	28480	0160-0576
A14A3C54	0160-0576	5		CAPACITOR-FXD .1UF +-20% 50VDC CER	28480	0160-0576
A14A3C55	0160-4527	4		CAPACITOR-FXD 56PF +-5% 200VDC CER 0+-30	28480	0160-4527
A14A3C56	0160-0576	5		CAPACITOR-FXD .1UF +-20% 50VDC CER	28480	0160-0576
A14A3C57	0160-0576	5		CAPACITOR-FXD .1UF +-20% 50VDC CER	28480	0160-0576
A14A3C58	0160-0576	5		CAPACITOR-FXD .1UF +-20% 50VDC CER	28480	0160-0576

See introduction to this section for ordering information.

\* Indicates factory selected value

Table 6-2. Replaceable Parts

Reference Designation	HP Part Number	C D	Qty	Description	Mfr Code	Mfr Part Number
A14A3C59	0160-4835	7		CAPACITOR-FXD .1UF +-10% 50VDC CER	28480	0160-4835
A14A3C60	0160-4835	7		CAPACITOR-FXD .1UF +-10% 50VDC CER	28480	0160-4835
A14A3C61	0160-5969	0		CAPACITOR-FXD 3.3PF +- .5PF 50VDC CER	28480	0160-5969
A14A3C62	0160-0576	5		CAPACITOR-FXD .1UF +-20% 50VDC CER	28480	0160-0576
A14A3C63	0160-5961	2		CAPACITOR-FXD 22PF +-5% 50VDC CER 0+-30	28480	0160-5961
A14A3C64	0160-0576	5		CAPACITOR-FXD .1UF +-20% 50VDC CER	28480	0160-0576
A14A3C65	0160-0576	5		CAPACITOR-FXD .1UF +-20% 50VDC CER	28480	0160-0576
A14A3C66	0160-5942	9		CAPACITOR-FXD 1PF +- .5PF 50VDC CER 0+-30	28480	0160-5942
2427A TO 2807A						
A14A3C67				NOT ASSIGNED		
A14A3C68				NOT ASSIGNED		
2825A AND ABOVE						
A14A3C67	0160-0576	5		CAPACITOR-FXD .1UF +-20% 50VDC CER	28480	0160-0576
A14A3C68	0160-0576	5		CAPACITOR-FXD .1UF +-20% 50VDC CER	28480	0160-0576
A14A3CR1	1900-0045	4	12	DIODE-PIN	28480	1900-0045
A14A3CR2	1900-0045	4		DIODE-PIN	28480	1900-0045
A14A3CR3	1900-0045	4		DIODE-PIN	28480	1900-0045
A14A3CR4	1900-0045	4		DIODE-PIN	28480	1900-0045
A14A3CR5	1900-0045	4		DIODE-PIN	28480	1900-0045
A14A3CR6	1900-0045	4		DIODE-PIN	28480	1900-0045
A14A3CR7	1900-0045	4		DIODE-PIN	28480	1900-0045
A14A3CR8	1900-0045	4		DIODE-PIN	28480	1900-0045
A14A3CR9	1900-0045	4		DIODE-PIN	28480	1900-0045
A14A3CR10	1900-0045	4		DIODE-PIN	28480	1900-0045
A14A3CR11	1900-0045	4		DIODE-PIN	28480	1900-0045
A14A3CR12	1900-0045	4		DIODE-PIN	28480	1900-0045
2427A TO 2640A						
A14A3CR13				NOT ASSIGNED		
A14A3CR14				NOT ASSIGNED		
A14A3CR15				NOT ASSIGNED		
2642A AND ABOVE						
A14A3CR13	1901-0179	7	3	DIODE-SWITCHING 15V 50MA 750PS DO-7	28480	1901-0179
A14A3CR14	1901-0179	7	3	DIODE-SWITCHING 15V 50MA 750PS DO-7	28480	1901-0179
A14A3CR15	1901-0179	7	3	DIODE-SWITCHING 15V 50MA 750PS DO-7	28480	1901-0179
A14A3FL1	9135-0214	4		FILTER-HIGH PASS PIN STYLE-TERMS	28480	9135-0214
A14A3FL2	9135-0214	4		FILTER-HIGH PASS PIN STYLE-TERMS	28480	9135-0214
A14A3FL3	9135-0214	4		FILTER-HIGH PASS PIN STYLE-TERMS	28480	9135-0214
A14A3FL4	9135-0214	4		FILTER-HIGH PASS PIN STYLE-TERMS	28480	9135-0214
A14A3FL5	9135-0214	4		FILTER-HIGH PASS PIN STYLE-TERMS	28480	9135-0214
	08642-20086	2	2	ELSTMR FEEDTHRU	28480	08642-20086
A14A3J1	1250-2090	4		CONNECTOR-RF SMC M SGL-HOLE-RR 50-OHM	28480	1250-2090
	08642-20081	7		ELSTMR COND SMC	28480	08642-20081
A14A3J2	1250-2090	4		CONNECTOR-RF SMC M SGL-HOLE-RR 50-OHM	28480	1250-2090
	08642-20081	7		ELSTMR COND SMC	28480	08642-20081
A14A3J3	1250-2090	4		CONNECTOR-RF SMC M SGL-HOLE-RR 50-OHM	28480	1250-2090
	08642-20081	7		ELSTMR COND SMC	28480	08642-20081
A14A3J4	1251-8758	5		CONN-POST TYPE .100-PIN-SPCG 8-CONT	28480	1251-8758
A14A3J5	1251-8948	5	2	CONN POST TYPE 2.5-PIN-SPCG 2-CONT	28480	1251-8948
A14A3J6	1252-0153	0	1	CONN POST TYPE .100-PIN-SPCG 10-CONT	28480	1252-0153
	1251-5595	2	23	POLARIZING KEY-POST CONN	28480	1251-5595
A14A3L1	9135-0079	9		INDUCTOR RF-CH-MLD 100NH 5% .102DX.26LG	28480	9135-0079
A14A3L2	9100-2256	5		INDUCTOR RF-CH-MLD 560NH 10% .105DX.26LG	28480	9100-2256
A14A3L3	9140-0142	8		INDUCTOR RF-CH-MLD 2.2UH 10% .105DX.26LG	28480	9140-0142
A14A3L4	9140-0142	8		INDUCTOR RF-CH-MLD 2.2UH 10% .105DX.26LG	28480	9140-0142
A14A3L5	9100-2256	5		INDUCTOR RF-CH-MLD 560NH 10% .105DX.26LG	28480	9100-2256
A14A3L6	9135-0078	8		INDUCTOR RF-CH-MLD 82NH 7% .102DX.26LG	28480	9135-0078
A14A3L7	9140-1087	2		INDUCTOR-FIXED 120-1300 HZ	28480	9140-1087
A14A3L8	9140-1087	2		INDUCTOR-FIXED 120-1300 HZ	28480	9140-1087
A14A3L9	9135-0079	9		INDUCTOR RF-CH-MLD 100NH 5% .102DX.26LG	28480	9135-0079
A14A3L10	9100-1650	1	1	INDUCTOR RF-CH-MLD 680UH 5% .2DX.45LG	28480	9100-1650
A14A3L11	9135-0078	8		INDUCTOR RF-CH-MLD 82NH 7% .102DX.26LG	28480	9135-0078
A14A3L12	9135-0079	9		INDUCTOR RF-CH-MLD 100NH 5% .102DX.26LG	28480	9135-0079
A14A3L13	9140-0245	2	1	INDUCTOR RF-CH-MLD 445UH 5% .29DX.924LG	28480	9140-0245
A14A3L14	9140-1087	2		INDUCTOR-FIXED 120-1300 HZ	28480	9140-1087
A14A3L15	9140-1087	2		INDUCTOR-FIXED 120-1300 HZ	28480	9140-1087
A14A3L16	9140-1087	2		INDUCTOR-FIXED 120-1300 HZ	28480	9140-1087
A14A3L17	9135-0073	3	4	INDUCTOR RF-CH-MLD 51NH 6% .102DX.26LG	28480	9135-0073
A14A3L18	9135-0073	3		INDUCTOR RF-CH-MLD 51NH 6% .102DX.26LG	28480	9135-0073
A14A3L19	9135-0073	3		INDUCTOR RF-CH-MLD 51NH 6% .102DX.26LG	28480	9135-0073
A14A3L20	9135-0073	3		INDUCTOR RF-CH-MLD 51NH 6% .102DX.26LG	28480	9135-0073

See introduction to this section for ordering information.

\* Indicates factory selected value



Table 6-2. Replaceable Parts

Reference Designation	HP Part Number	C D	Qty	Description	Mfr Code	Mfr Part Number
A14A3L21	9100-2249	6		INDUCTOR RF-CH-MLD 150NH 10% .105DX.26LG	28480	9100-2249
A14A3L22	9100-2249	6		INDUCTOR RF-CH-MLD 150NH 10% .105DX.26LG	28480	9100-2249
A14A3L23	9140-1087	2		INDUCTOR-FIXED 120-1300 HZ	28480	9140-1087
A14A3Q1	1853-0459	3		TRANSISTOR PNP SI PD=625Mw FT=200MHZ	28480	1853-0459
A14A3Q2	1854-1008	2		TRANSISTOR NPN SI PD=600Mw FT=2GHZ	28480	1854-1008
A14A3Q3	1853-0459	3		TRANSISTOR PNP SI PD=625Mw FT=200MHZ	28480	1853-0459
A14A3Q4	1854-1008	2		TRANSISTOR NPN SI PD=600Mw FT=2GHZ	28480	1854-1008
A14A3Q5	1853-0459	3		TRANSISTOR PNP SI PD=625Mw FT=200MHZ	28480	1853-0459
A14A3Q6	1854-1036	6		TRANSISTOR NPN SI PD=2.5w	28480	1854-1036
2427A TO 2807A A14A3Q7-Q10				NOT ASSIGNED		
2825A AND ABOVE A14A3Q7	1854-1202	8		TRANSISTOR NPN SI DARL TO-92 PD=625 Mw	02307	MPSA27
A14A3Q8	1853-0459	3		TRANSISTOR PNP SI PD=625Mw FT=200MHZ	28480	1853-0459
A14A3Q9	1854-1202	8		TRANSISTOR NPN SI DARL TO-92 PD=625Mw	02307	MPSA27
A14A3Q10	1853-0459	3		TRANSISTOR PNP SI PD=625Mw FT=200MHZ	28480	1853-0459
A14A3R1	0699-2196	0	2	RESISTOR 78.8 2% .125w C T=0+-125	28480	0699-2196
A14A3R2	0699-1828	3	1	RESISTOR 106 2% .125w C TC=0+-125	28480	0699-1828
A14A3R3	0699-2196	0		RESISTOR 78.8 2% .125w C T=0+-125	28480	0699-2196
A14A3R4	0698-7236	7		RESISTOR 1K 1% .05w F TC=0+-100	24546	C3-1/8-T0-1001-F
A14A3R5	0698-7257	2		RESISTOR 7.5K 1% .05w F TC=0+-100	24546	C3-1/8-T0-7501-F
A14A3R6	0698-7248	1		RESISTOR 3.16K 1% .05w F TC=0+-100	24546	C3-1/8-T0-3161-F
A14A3R7	0757-0394	0		RESISTOR 51.1 1% .125w F TC=0+-100	24546	C4-1/8-T0-51R1-F
A14A3R8	0698-3444	1		RESISTOR 316 1% .125w F TC=0+-100	24546	C4-1/8-T0-316R-F
A14A3R9	0698-7222	1		RESISTOR 261 1% .05w F TC=0+-100	24546	C3-1/8-T0-261R-F
2427A TO 2807A A14A3R10	0698-7212	9		RESISTOR 100 1% .05w F TC=0+-100	24546	C3-1/8-T0-100R-F
2825A AND ABOVE A14A3R10	0698-7196	8		RESISTOR 21.5 1% .05w F TC=0+-100	24546	C3-1/8-T0-21R5-F
A14A3R11	0699-1346	0	3	RESISTOR 15.4 1% .125w C TC=0+-125	28480	0699-1346
A14A3R12	0699-1352	8		RESISTOR 15.4 1% .125w C TC=0+-125	28480	0699-1352
A14A3R13				NOT ASSIGNED		
A14A3R14				NOT ASSIGNED		
A14A3R15	0757-0338	2	6	RESISTOR 1K 1% .25w F TC=0+-100	24546	C5-1/4-T0-1001-F
A14A3R16	0757-1022	3	2	RESISTOR 1.78K 1% .25w F TC=0+-100	24546	C5-1/4-T0-1781-F
A14A3R17	0757-1022	3		RESISTOR 1.78K 1% .25w F TC=0+-100	24546	C5-1/4-T0-1781-F
A14A3R18	0757-0338	2		RESISTOR 1K 1% .25w F TC=0+-100	24546	C5-1/4-T0-1001-F
A14A3R19	0757-0338	2		RESISTOR 1K 1% .25w F TC=0+-100	24546	C5-1/4-T0-1001-F
A14A3R20	0757-0338	2		RESISTOR 1K 1% .25w F TC=0+-100	24546	C5-1/4-T0-1001-F
A14A3R21	0698-7201	6		RESISTOR 34.8 1% .05w F TC=0+-100	24546	C3-1/8-T0-34R8-F
A14A3R22	0757-0179	9		RESISTOR 196 1% .25w F TC=0+-100	24546	C5-1/4-T0-196R-F
A14A3R23	0698-7236	7		RESISTOR 1K 1% .05w F TC=0+-100	24546	C3-1/8-T0-1001-F
A14A3R24	0698-7257	2		RESISTOR 7.5K 1% .05w F TC=0+-100	24546	C3-1/8-T0-7501-F
A14A3R25	0698-7248	1		RESISTOR 3.16K 1% .05w F TC=0+-100	24546	C3-1/8-T0-3161-F
A14A3R26	0698-7222	1		RESISTOR 261 1% .05w F TC=0+-100	24546	C3-1/8-T0-261R-F
2427A TO 2807A A14A3R27	0698-7205	0		RESISTOR 51.1 1% .05w F TC=0+-100	24546	C3-1/8-T0-51R1-F
2825A AND ABOVE A14A3R27				NOT ASSIGNED		
A14A3R28	0699-1350	6	2	RESISTOR 17.8 1% .125w C TC=0+-125	28480	0699-1350
A14A3R29	0699-1350	6		RESISTOR 17.8 1% .125w C TC=0+-125	28480	0699-1350
A14A3R30				NOT ASSIGNED		
A14A3R31				NOT ASSIGNED		
A14A3R32	0698-7236	7		RESISTOR 1K 1% .05w F TC=0+-100	24546	C3-1/8-T0-1001-F
A14A3R33	0698-7257	2		RESISTOR 7.5K 1% .05w F TC=0+-100	24546	C3-1/8-T0-7501-F
A14A3R34	0698-7248	1		RESISTOR 3.16K 1% .05w F TC=0+-100	24546	C3-1/8-T0-3161-F
A14A3R35	0699-1424	5	1	RESISTOR 237 1% .125w C TC=0+-125	28480	0699-1424
A14A3R36	0757-0379	1	1	RESISTOR 12.1 1% .125w F TC=0+-100	19701	MF4C1/8-T0-12R1-F
A14A3R37				NOT ASSIGNED		
A14A3R38	0699-1348	2	2	RESISTOR 14.7 1% .125w C TC=0+-125	28480	0699-1348
A14A3R39	0699-1348	2		RESISTOR 14.7 1% .125w C TC=0+-125	28480	0699-1348
A14A3R40				NOT ASSIGNED		
A14A3R41	0757-0420	3		RESISTOR 750 1% .125w F TC=0+-100	24546	C4-1/8-T0-751-F
A14A3R42	0757-0420	3		RESISTOR 750 1% .125w F TC=0+-100	24546	C4-1/8-T0-751-F
A14A3R43	0757-0420	3		RESISTOR 750 1% .125w F TC=0+-100	24546	C4-1/8-T0-751-F
A14A3R44	0757-0420	3		RESISTOR 750 1% .125w F TC=0+-100	24546	C4-1/8-T0-751-F
A14A3R45	0698-3446	3		RESISTOR 383 1% .125w F TC=0+-100	24546	C4-1/8-T0-383R-F

See introduction to this section for ordering information.

\* Indicates factory selected value

Table 6-2. Replaceable Parts

Reference Designation	HP Part Number	C D	Qty	Description	Mfr Code	Mfr Part Number
A14A3R46	0699-1361	9		RESISTOR 51.1 1% .125W F TC=0+-100	28480	0699-1361
2427A TO 2530A A14A3R47	0698-7215	2	3	RESISTOR 133 1% .05W F TC=0+-100	24546	C3-1/8-TO-133R-F
A14A3R48	2100-3091	1	1	RESISTOR-TRMR 2K 10% C TOP-ADJ 17-TRN	32997	3292W-1-202
A14A3R49	0698-7215	2		RESISTOR 133 1% .05W F TC=0+-100	24546	C3-1/8-TO-133R-F
2537A AND ABOVE A14A3R47	0698-7215	2		RESISTOR 196 1% .05W F TC=0+-100	24546	C3-1/8-TO-196R-F
A14A3R48	2100-3090	0		RESISTOR-TRMR 500 10% C TOP-ADJ 17-TRN	32997	3292W-1-501
A14A4R49	0698-7209	4		RESISTOR 75 1% .05W F TC=0+-100	24546	C3-1/8-TO-75R0-F
A14A3R50	8159-0005	0	1	RESISTOR-ZERO OHMS 22 AWG LEAD DIA	28480	8159-0005
2427A TO 2807A A14A3R51	0698-7195	7		RESISTOR 19.6 1% .05W F TC=0+-100	24546	C3-1/8-TO-19R6-F
2825A AND ABOVE A14A3R51	0698-7188	8		RESISTOR 10 1% .05W F TC=0+-100	24546	C3-1/8-TO-10R-F
2427A TO 2530A A14A3R52	0699-1354	6		RESISTOR 26.1 1% .125W F TC=0+-100	28480	0699-1354
2537A AND ABOVE A14A3R52*	0699-1503	1		RESISTOR -ZERO OHMS SMD ZERO OHM JUMPER	00746	9C1206
A14A3R53	0698-7260	7		RESISTOR 10K 1% .05W F TC=0+-100	24546	C3-1/8-TO-1002-F
2427A TO 2807A A14A3R54-R65				NOT ASSIGNED		
2825A AND ABOVE A14A3R54	0698-7260	7		RESISTOR 10K 1% .05W F TC=0+-100	24546	C3-1/8-TO-1002-F
A14A3R55	0698-7250	5		RESISTOR 3.83K 1% .05W F TC=0+-100	24546	C3-1/8-TO-3831-F
A14A3R56	0698-7243	6		RESISTOR 1.96K 1% .05W F TC=0+-100	24546	C3-1/8-TO-1961-F
A14A3R57	0698-7243	6		RESISTOR 1.96K 1% .05W F TC=0+-100	24546	C3-1/8-TO-1961-F
A14A3R58				NOT ASSIGNED		
A14A3R59				NOT ASSIGNED		
A14A3R60	0757-0442	9		RESISTOR 10K 1% .125W F TC=0+-100	24546	C4-1/8-TO-1002-F
A14A3R61	0757-0442	9		RESISTOR 10K 1% .125W F TC=0+-100	24546	C4-1/8-TO-1002-F
A14A3R62	0699-1415	4		RESISTOR 100 1% .125W TKF TC=0+-100	04935	9C12063AFKRT
A14A3R63	0699-1415	4		RESISTOR 100 1% .125W TKF TC=0+-100	04935	9C12063AFKRT
A14A3R64	0699-1415	4		RESISTOR 100 1% .125W TKF TC=0+-100	04935	9C12063AFKRT
A14A3R65	0699-1415	4		RESISTOR 100 1% .125W TKF TC=0+-100	04935	9C12063AFKRT
A14A3RT1	0837-0307	5	1	THERMISTOR DISC 100-OHM TC=-4.4%/C-DEG	28480	0837-0307
A14A3TP1	1251-2194	1		CONNECTOR-SGL CONT SKT .021-IN-BSC-SZ	28480	1251-2194
A14A3TP2	1251-2194	1		CONNECTOR-SGL CONT SKT .021-IN-BSC-SZ	28480	1251-2194
A14A3TP3	1251-2194	1		CONNECTOR-SGL CONT SKT .021-IN-BSC-SZ	28480	1251-2194
A14A3TP4	1251-2194	1		CONNECTOR-SGL CONT SKT .021-IN-BSC-SZ	28480	1251-2194
2427A TO 2807A A14A3U1	1820-3691	2	1	IC XLTR TTL TTL-TO-MOS DUAL	28480	1820-3691
2825A AND ABOVE A14A3U1	1826-0412	1		IC COMPARTOR-FXD 30PF +-5% 200VDC CER	28480	LM393N
A14A3W1	0955-0234	7	1	NOT ASSIGNED	28480	0955-0234
A14A3Z1	1251-2194	1		MIXER .05-2000MHZ CONNECTOR-SGL CONT SKT .021-IN-BSC-SZ	28480	1251-2194

See introduction to this section for ordering information.

\* Indicates factory selected value

Table 6-2. Replaceable Parts

Reference Designation	HP Part Number	C D	Qty	Description	Mfr Code	Mfr Part Number
<b>A15</b>						
2427A TO 2810A A15	08642-60129	8	1	HP-IB CONNECTOR ASSEMBLY	28480	08642-60129
2816A AND ABOVE A15	08642-60229	9	1	HP-IB CONNECTOR ASSEMBLY	28480	08642-60229
A15J1	1251-7772	1	1	CONN-REG CHAMP 24-CKT 24-CONT	28480	1251-7772
2427A TO 2810A A15J2	1251-7447	7	1	CONN POST 34 M2R	28480	1251-7447
2816A AND ABOVE A15J2	1251-5720	5	1	CONNECTOR 34-PIN M POST TYPE	28480	1251-5720
A15J3	1251-0600	0	4	CONNECTOR-SGL CONT PIN 1.14-MM-BSC-SZ SQ	28480	1251-0600
A15J4	1251-0600	0		CONNECTOR-SGL CONT PIN 1.14-MM-BSC-SZ SQ	28480	1251-0600
A15J5	1251-0600	0		CONNECTOR-SGL CONT PIN 1.14-MM-BSC-SZ SQ	28480	1251-0600
A15J6	1251-0600	0		CONNECTOR-SGL CONT PIN 1.14-MM-BSC-SZ SQ	28480	1251-0600
A15MP1	0380-1180	5	2	STANDOFF-HEX 5-MM-LG 7.1-MM-A/F STL	00000	ORDER BY DESCRIPTION
A15MP2	0515-0655	4		SCREW-MACH M3 X 0.5 8MM-LG PAN-HD	00000	ORDER BY DESCRIPTION
A15MP3	1251-7773	2	1	SHIELD-AMP CHAMP 24 CONT CONN	28480	1251-7773
A15MP4	08642-20068	0	2	BRACKET HP-IB	28480	08642-20068
2427A TO 2810A A15MP5				NOT ASSIGNED		
2816A AND ABOVE A15MP5	1251-5595	2		POLARIZING KEY-POST CONN	28480	1251-5595

See introduction to this section for ordering information.

\* Indicates factory selected value

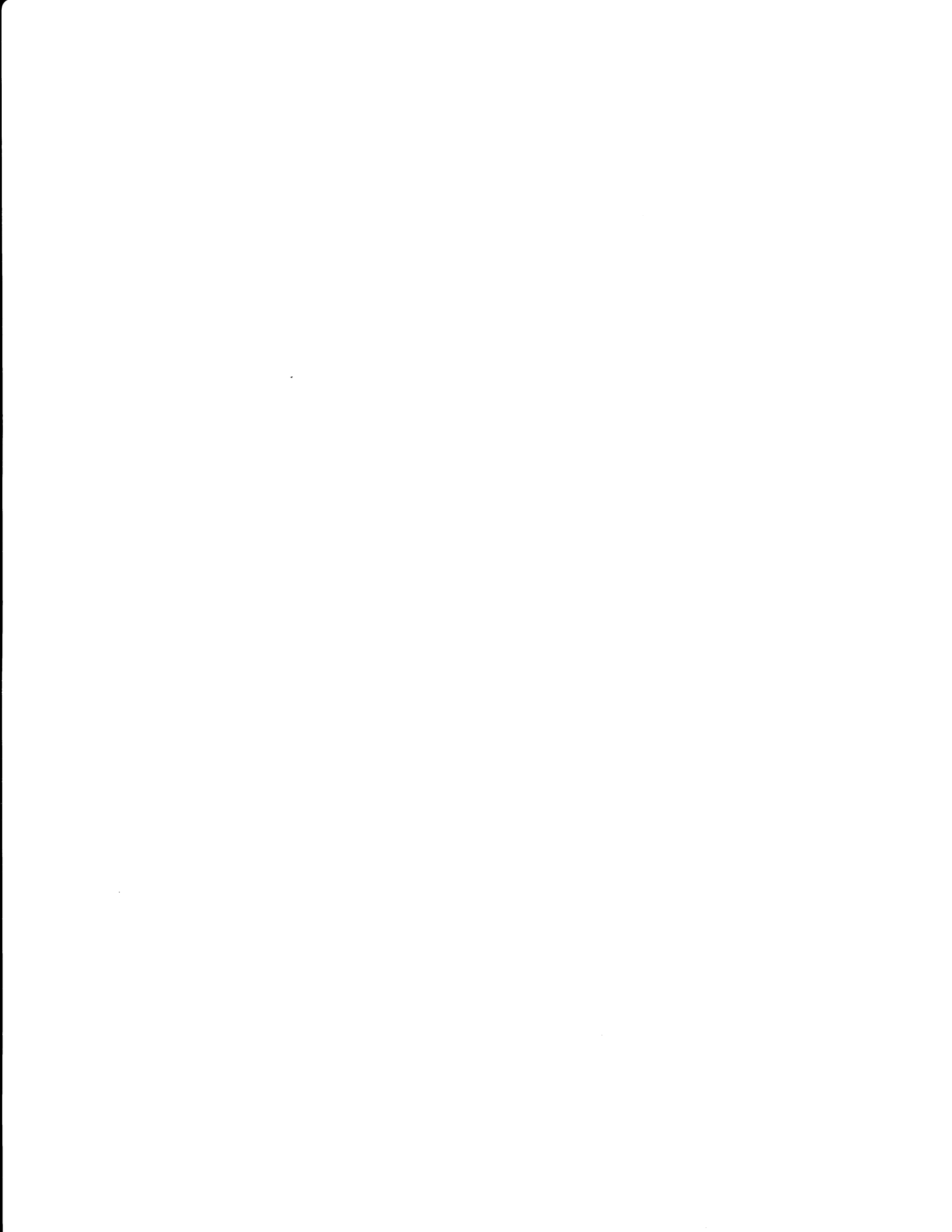

Table 6-2. Replaceable Parts

Reference Designation	HP Part Number	C D	Qty	Description	Mfr Code	Mfr Part Number
<b>A 16</b>						
A16	08642-60842	2	1	ATTENUATOR MODULE (8642A STANDARD ONLY)	28480	08642-60842
A16	08642-69842	0	1	ATTENUATOR MODULE (8642A STANDARD ONLY) (RESTORED)	28480	08642-69842
A16AT1	08642-60954	7	1	ATTENUATOR ASSEMBLY	28480	08642-60954
A16MP1	08642-00112	3	1	ATTENUATOR FRAME	28480	08642-00112
A16MP2	0380-0008	4	4	SPACER-RND .5-IN-LG .18-IN-ID .25-IN-OD (BETWEEN A16A1 AND A16MP1)	00000	ORDER BY DESCRIPTION
A16MP3	0515-0655	4	4	SCREW-MACH M3X0.5 8MM-LG PAN-HD (ATTACH A16A1 TO A16MP1)	00000	ORDER BY DESCRIPTION
A16MP4	0515-0680	5	8	SCREW-MACH M3 X 0.5 6MM-LG PAN-HD (ATTACH A16AT1 AND A16A1 TO A16MP1)	28480	0515-0680
A16MP5	2190-0584	0		WASHER-LK HLCL 3.0 MM 3.1-MM-ID	28480	2190-0584
A16MP6	08642-00049	5		SLIDE-MDL469R56 (FRONT AND REAR)	28480	08642-00049
A16MP7	08642-00052	0		SLIDE-MODULE R89 (REAR)	28480	08642-00052
A16MP8	0515-1102	8		SCREW-MACH M3 X 0.5 8MM-LG 90-DEG-FLH-HD (ATTACH A16MP6, A16MP7 TO A16MP1)	28480	0515-1102
A16MP9	08642-20072	6	7	MODULE SLIDE RIBBON CABLE SCREW	28480	08642-20072
A16MP10	08642-80071	1	1	LABEL-ATTEN 60008	28480	08642-80071
<b>A 16</b>						
<b>OPTION 003 ONLY</b>						
A16	08642-60848	8	1	ATTENUATOR MODULE (8642A OPTION 003)	28480	08642-60848
A16	08642-69848	6	1	ATTENUATOR MODULE (8642A OPTION 003) (RESTORED)	28480	08642-69848
A16AT1	08642-60962	7	1	70 DB ATTENUATOR	28480	08642-60962
A16AT2	08642-60963	8	1	75 DB ATTENUATOR	28480	08642-60963
A16MP1	2200-0109	8	2	SCREW-MACH 4-40 .438-IN-LG PAN-HD-POZI (ATTACH AT1, AT2 BOTTOM TO BASE)	00000	ORDER BY DESCRIPTION
A16MP2	2200-0103	2	2	SCREW-MACH 4-40 .25-IN-LG PAN-HD-POZI (ATTACH AT1, AT2 TOP TO BASE)	28480	2200-0103
A16MP3	08642-40025	1	1	COVER ATTENUATOR RPP	28480	08642-40025
A16MP4	08642-20026	0	1	BASE ATTENUATOR	28480	08642-20026
A16MP5	8160-0472	8		RFI ROUND STRIP BE-CU SN-PL .093-IN-OD (SPIRA SHIELD)	28480	8160-0472
A16MP6	08642-00049	5		SLIDE-MDL469R56 (FRONT)	28480	08642-00049
A16MP7	08642-00052	0		SLIDE-MODULE R89 (REAR)	28480	08642-00052
A16MP8	0515-1102	8		SCREW-MACH M3 X 0.5 8MM-LG 90-DEG-FLH-HD	28480	0515-1102
A16W1	08642-20057	7	1	CABLE SR A70-A75 (A16AT1J2 TO A16AT2J2)	28480	08642-20057
A16W2	08642-20047	5	1	CABLE SR A75-RPP (A16AT2J1 TO A16A2J1)	28480	08642-20047

See introduction to this section for ordering information.

\* Indicates factory selected value

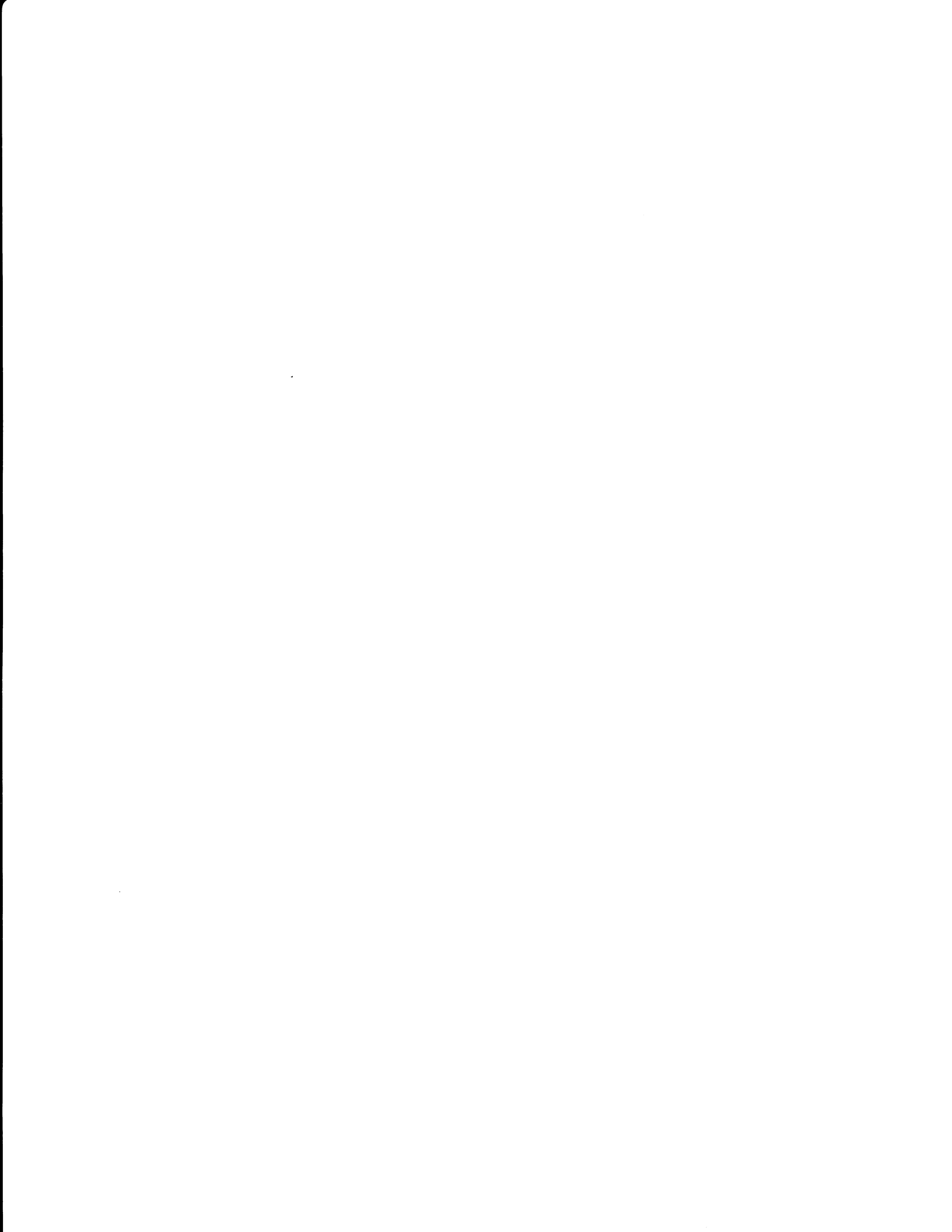

Table 6-2. Replaceable Parts

Reference Designation	HP Part Number	C D	Qty	Description	Mfr Code	Mfr Part Number
<b>A16A1</b>	08642-60117	4	1	ATTENUATOR INTERCONNECTION ASSEMBLY (8642A STANDARD ONLY)	28480	08642-60117
A16A1CR1	1901-0050	3		DIODE SWITCHING 80V 200MA 2NS DO-35	28480	1901-0050
A16A1CR2	1901-0050	3		DIODE SWITCHING 80V 200MA 2NS DO-35	28480	1901-0050
A16A1CR3	1901-0050	3		DIODE SWITCHING 80V 200MA 2NS DO-35	28480	1901-0050
A16A1CR4	1901-0050	3		DIODE SWITCHING 80V 200MA 2NS DO-35	28480	1901-0050
A16A1CR5	1901-0050	3		DIODE SWITCHING 80V 200MA 2NS DO-35	28480	1901-0050
A16A1CR6	1901-0050	3		DIODE SWITCHING 80V 200MA 2NS DO-35	28480	1901-0050
A16A1CR7	1901-0050	3		DIODE SWITCHING 80V 200MA 2NS DO-35	28480	1901-0050
A16A1J1	1251-5720	5		CONNECTOR 34-PIN M POST-TYPE	28480	1251-5720
	1251-5595	2		POLARIZING KEY-POST CONN	28480	1251-5595
A16A1R1	1810-0204	6		NETWORK-RES 8-SIP 1.0K OHMX7	01121	208A102
A16A1R2	1810-0206	8		NETWORK-RES 8-SIP 10.0K OHMX7	01121	208A103
A16A1U1	1820-2273	4		IC DRVR TTL OCTL	13606	UDN2981A
<b>A16A1</b>	08642-60145	8	1	ATTENUATOR INTERCONNECTION ASSEMBLY (OPTION 003 ONLY)	28480	08642-60145
A16A1J1	1251-8813	3		CONN-POST TYPE .100-PIN-SPCG 14-CONT	28480	1251-8813
A16A1J2	1251-8601	7	1	CONN-POST TYPE .100-PIN-SPCG 34-CONT	28480	1251-8601
	1251-5595	2		POLARIZING KEY-POST CONN	28480	1251-5595
A16A1J3				PRINTED CIRCUIT PADS		
A16A1R1	0698-7236	7		RESISTOR 1K 1% .05W F TC=0+-100	24546	C3-1/8-T0-1001-F
A16A1W1	08642-60073	1	1	CABLE ASSEMBLY (A16A1J3 TO A16A2J3)	28480	08642-60073

See introduction to this section for ordering information.

\* Indicates factory selected value

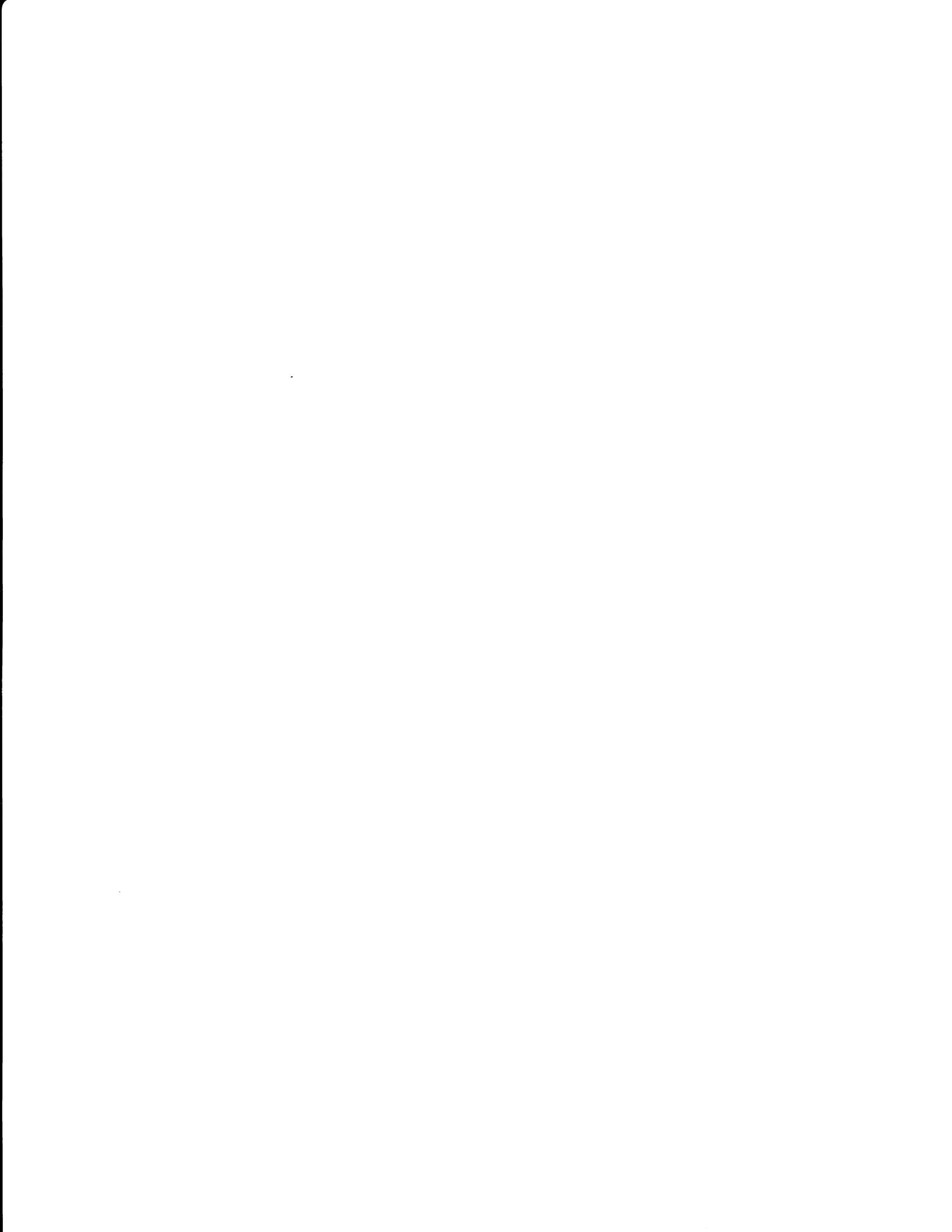



Table 6-2. Replaceable Parts

Reference Designation	HP Part Number	C D	Qty	Description	Mfr Code	Mfr Part Number
<b>A 16A2</b>	08642-60119	6	1	REVERSE POWER PROTECT ASSEMBLY (OPTION 003 ONLY)	28480	08642-60119
A16A2C1	0160-0546	9	2	CAPACITOR-FXD .1UF +-20% 100VDC CER	16546	W100KI104M
A16A2C2	0160-0546	9		CAPACITOR-FXD .1UF +-20% 100VDC CER	16546	W100KI104M
<i>2427A TO 2640A A16A2CR1</i>	1901-0539	3		DIODE-SM SIG SCHOTTKY	28480	1901-0539
<i>2708A AND ABOVE A16A2CR1</i>	1901-0539	3		DIODE-SM SIG SCHOTTKY	28480	1901-0539
	9170-0029	3		CORE-SHIELDING BEAD	28480	9170-0029
A16A2FL1	9135-0214	4		FILTER-HIGH PASS PIN STYLE-TERMS	28480	9135-0214
A16A2FL2	9135-0214	4		FILTER-HIGH PASS PIN STYLE-TERMS	28480	9135-0214
A16A2J1	1250-2091	5	2	CONNECTOR-RF SMA PC	28480	1250-2091
	08642-20079	3	3	ELSTMR CNDCT SMA	28480	08642-20079
A16A2J2	08642-80018	6		CONNECTOR-RF	28480	08642-80018
	08642-20079	3		ELSTMR CNDCT SMA	28480	08642-20079
A16A2J3	1251-8948	5		CONN POST TYPE 2.5-PIN-SPCG 2-CONT	28480	1251-8948
A16A2K1	0490-1452	7	1	RELAY-REED 1A 500MA 100VDC 5VDC-COIL	28480	0490-1452
A16A2U1	08642-67004	2	1	X2 REV PWR LIMTR	28480	08642-67004

See introduction to this section for ordering information.

\* Indicates factory selected value

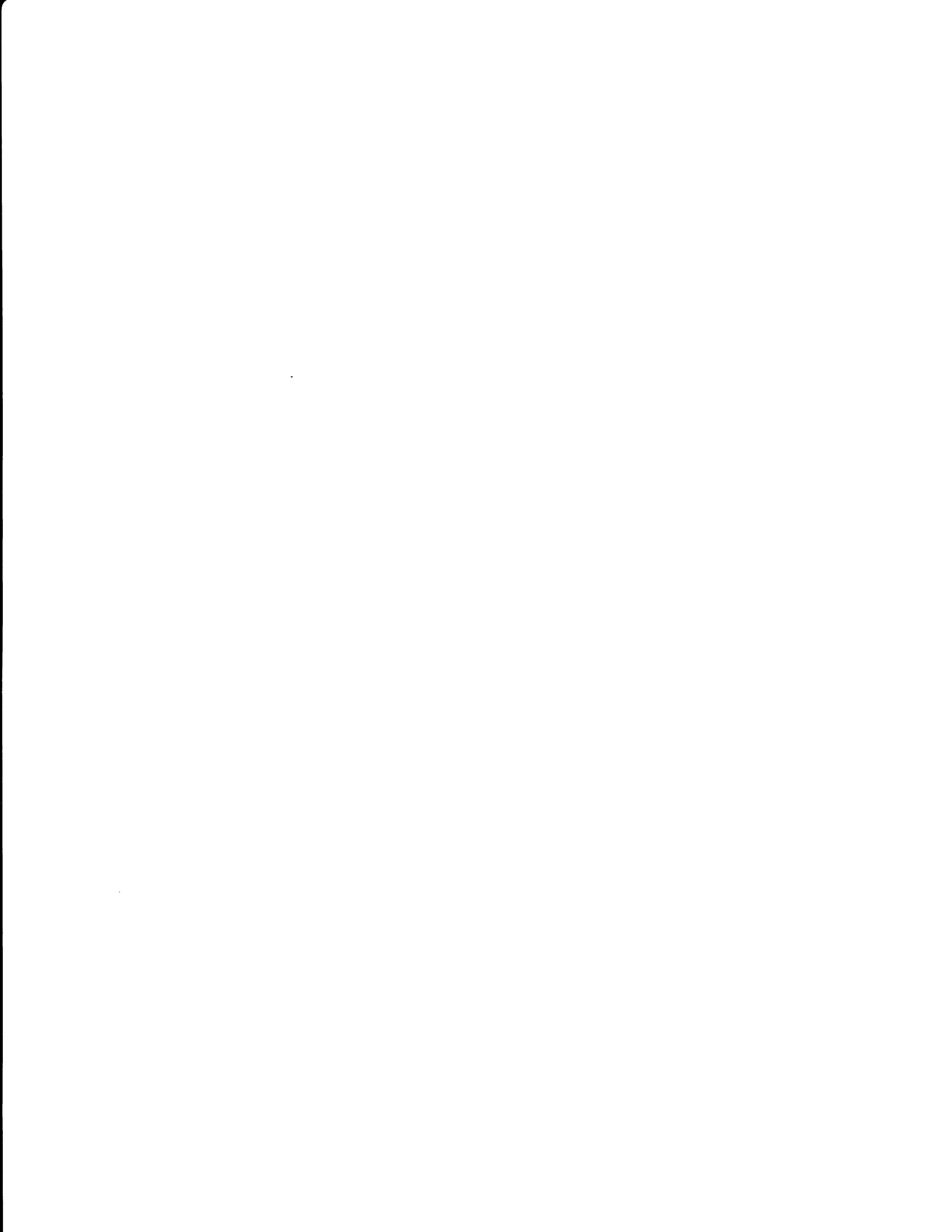

Table 6-2. Replaceable Parts

Reference Designation	HP Part Number	C D	Qty	Description	Mfr Code	Mfr Part Number
<b>A17</b>						
A17	08642-60843	3	1	POWER SUPPLY REGULATORS/ATTENUATOR DRIVERS MODULE	28480	08642-60843
A17	08642-69843	1	1	POWER SUPPLY REGULATORS/ATTENUATOR DRIVERS MODULE (RESTORED)	28480	08642-69843
A17C1-C7				NOT ASSIGNED		
A17C8	0160-4810	8	4	CAPACITOR-FXD 330PF +-5% 100VDC CER	28480	0160-4810
A17C9	0160-4835	7		CAPACITOR-FXD .1UF +-10% 50VDC CER	28480	0160-4835
A17C10	0160-4832	4		CAPACITOR-FXD .01UF +-10% 100VDC CER	28480	0160-4832
A17C11	0180-2374	7		CAPACITOR-FXD 100UF+-10% 20VDC TA	56289	150D107X9020X2
A17C12	0160-4810	8		CAPACITOR-FXD 330PF +-5% 100VDC CER	28480	0160-4810
A17C13	0160-4835	7		CAPACITOR-FXD .1UF +-10% 50VDC CER	28480	0160-4835
A17C14	0160-4832	4		CAPACITOR-FXD .01UF +-10% 100VDC CER	28480	0160-4832
A17C15	0180-2374	7		CAPACITOR-FXD 100UF+-10% 20VDC TA	56289	150D107X9020X2
A17C16	0160-4832	4		CAPACITOR-FXD .01UF +-10% 100VDC CER	28480	0160-4832
A17C17	0180-2207	5		CAPACITOR-FXD 100UF+-10% 10VDC TA	56289	150D107X9010R2
A17C18	0160-4832	4		CAPACITOR-FXD .01UF +-10% 100VDC CER	28480	0160-4832
A17C19	0180-2207	5		CAPACITOR-FXD 100UF+-10% 10VDC TA	56289	150D107X9010R2
A17C20	0160-4832	4		CAPACITOR-FXD .01UF +-10% 100VDC CER	28480	0160-4832
A17C21	0180-2610	4	1	CAPACITOR-FXD 10UF+-10% 75VDC TA	00904	T110A106K075AS
A17C22	0160-4835	7		CAPACITOR-FXD .1UF +-10% 50VDC CER	28480	0160-4835
A17C23	0160-4574	1		CAPACITOR-FXD 1000PF +-10% 100VDC CER	28480	0160-4574
A17C24				NOT ASSIGNED		
A17C25				NOT ASSIGNED		
A17C26	0160-4810	8		CAPACITOR-FXD 330PF +-5% 100VDC CER	28480	0160-4810
A17C27	0160-4441	1		CAPACITOR-FXD .47UF +-10% 50VDC CER	28480	0160-4441
A17C28	0160-4810	8		CAPACITOR-FXD 330PF +-5% 100VDC CER	28480	0160-4810
A17C29	0160-4835	7		CAPACITOR-FXD .1UF +-10% 50VDC CER	28480	0160-4835
A17C30-C100				NOT ASSIGNED		
A17C101	0180-0291	3		CAPACITOR-FXD 1UF+-10% 35VDC TA	56289	150D105X9035A2
A17C102	0180-0291	3		CAPACITOR-FXD 1UF+-10% 35VDC TA	56289	150D105X9035A2
A17C103	0160-4832	4		CAPACITOR-FXD .01UF +-10% 100VDC CER	28480	0160-4832
A17C104	0160-4832	4		CAPACITOR-FXD .01UF +-10% 100VDC CER	28480	0160-4832
A17C105	0160-4832	4		CAPACITOR-FXD .01UF +-10% 100VDC CER	28480	0160-4832
A17C106	0160-4832	4		CAPACITOR-FXD .01UF +-10% 100VDC CER	28480	0160-4832
A17C107	0180-0291	3		CAPACITOR-FXD 1UF+-10% 35VDC TA	56289	150D105X9035A2
A17C108	0180-0291	3		CAPACITOR-FXD 1UF+-10% 35VDC TA	56289	150D105X9035A2
A17C109	0160-4832	4		CAPACITOR-FXD .01UF +-10% 100VDC CER	28480	0160-4832
A17C110	0160-4832	4		CAPACITOR-FXD .01UF +-10% 100VDC CER	28480	0160-4832
A17C111	0160-4832	4		CAPACITOR-FXD .01UF +-10% 100VDC CER	28480	0160-4832
A17C112	0160-4832	4		CAPACITOR-FXD .01UF +-10% 100VDC CER	28480	0160-4832
A17C113	0180-0347	0	2	CAPACITOR-FXD 1.5UF+-10% 35VDC TA	56289	150D155X9035B2
A17C114	0180-0347	0		CAPACITOR-FXD 1.5UF+-10% 35VDC TA	56289	150D155X9035B2
A17C115	0180-2207	5		CAPACITOR-FXD 100UF+-10% 10VDC TA	56289	150D107X9010R2
A17C116	0160-4835	7		CAPACITOR-FXD .1UF +-10% 50VDC CER	28480	0160-4835
A17C117-C119				NOT ASSIGNED		
A17C120	0160-4791	4		CAPACITOR-FXD 10PF +-5% 100VDC CER 0+-30	28480	0160-4791
A17C121	0160-4832	4		CAPACITOR-FXD .01UF +-10% 100VDC CER	28480	0160-4832
A17CR1	1901-0028	5		DIODE-PWR RECT 400V 750MA DO-29	28480	1901-0028
A17CR2	1901-0050	3		DIODE-SWITCHING 80V 200MA 2NS DO-35	28480	1901-0050
A17CR3	1901-0050	3		DIODE-SWITCHING 80V 200MA 2NS DO-35	28480	1901-0050
A17CR4	1901-0050	3		DIODE-SWITCHING 80V 200MA 2NS DO-35	28480	1901-0050
A17CR5	1901-0050	3		DIODE-SWITCHING 80V 200MA 2NS DO-35	28480	1901-0050
A17CR6	1901-0050	3		DIODE-SWITCHING 80V 200MA 2NS DO-35	28480	1901-0050
A17CR7	1901-0028	5		DIODE-PWR RECT 400V 750MA DO-29	28480	1901-0028
A17CR8	1901-0050	3		DIODE-SWITCHING 80V 200MA 2NS DO-35	28480	1901-0050
A17CR9	1901-0050	3		DIODE-SWITCHING 80V 200MA 2NS DO-35	28480	1901-0050
A17CR10	1901-0050	3		DIODE-SWITCHING 80V 200MA 2NS DO-35	28480	1901-0050
A17CR11	1901-0050	3		DIODE-SWITCHING 80V 200MA 2NS DO-35	28480	1901-0050
A17CR12	1901-0050	3		DIODE-SWITCHING 80V 200MA 2NS DO-35	28480	1901-0050
A17CR13				NOT ASSIGNED		
A17CR14	1901-0050	3		DIODE-SWITCHING 80V 200MA 2NS DO-35	28480	1901-0050
A17CR15	1901-0028	5		DIODE-PWR RECT 400V 750MA DO-29	28480	1901-0028

See introduction to this section for ordering information.

\* Indicates factory selected value

Table 6-2. Replaceable Parts

Reference Designation	HP Part Number	C D	Qty	Description	Mfr Code	Mfr Part Number
A17CR16	1901-0050	3		DIODE-SWITCHING 80V 200MA 2NS DO-35	28480	1901-0050
A17CR17	1901-0028	5		DIODE-PWR RECT 400V 750MA DO-29	28480	1901-0028
A17CR18	1901-0028	5		DIODE-PWR RECT 400V 750MA DO-29	28480	1901-0028
2427A TO 2647A A17CR19-CR23 2709A AND ABOVE				NOT ASSIGNED		
A17CR19	1901-0050	3		DIODE-SWITCHING 80V 200MA 2NS DO-35	28480	1901-0050
A17CR20	1901-0050	3		DIODE-SWITCHING 80V 200MA 2NS DO-35	28480	1901-0050
A17CR21	1901-0050	3		DIODE-SWITCHING 80V 200MA 2NS DO-35	28480	1901-0050
A17CR22	1901-0050	3		DIODE-SWITCHING 80V 200MA 2NS DO-35	28480	1901-0050
A17CR23	1901-0050	3		DIODE-SWITCHING 80V 200MA 2NS DO-35	28480	1901-0050
A17DS1	1990-0835	9	5	LED-LAMP LUM-INT=6MCD IF=30MA-MAX BVR=5V	28480	HLMP-1523
A17DS2	1990-0835	9		LED-LAMP LUM-INT=6MCD IF=30MA-MAX BVR=5V	28480	HLMP-1523
A17DS3	1990-0835	9		LED-LAMP LUM-INT=6MCD IF=30MA-MAX BVR=5V	28480	HLMP-1523
A17DS4	1990-0835	9		LED-LAMP LUM-INT=6MCD IF=30MA-MAX BVR=5V	28480	HLMP-1523
A17DS5	1990-0835	9		LED-LAMP LUM-INT=6MCD IF=30MA-MAX BVR=5V	28480	HLMP-1523
A17F1	2110-0047	2	1	FUSE 1A 125V .25X.27	71400	GMW-1
A17J1	1251-2313	6	2	CONNECTOR-SGL CONT SKT .04-IN-BSC-SZ RND	28480	1251-2313
A17J1	1251-6982	3	1	CONNECTOR 14-PIN M POST TYPE	28480	1251-6982
A17J2	1251-5653	3	2	CONNECTOR 50-PIN M POST TYPE	28480	1251-5653
A17J2	1251-5595	2		POLARIZING KEY-POST CONN	28480	1251-5595
A17J3	1251-5653	3		CONNECTOR 50-PIN M POST TYPE	28480	1251-5653
A17J3	1251-5595	2		POLARIZING KEY-POST CONN	28480	1251-5595
A17MP1	08642-20077	1	1	HEATSINK MAIN	28480	08642-20077
A17MP2	08642-00098	4	1	FOAM 9.5 FIRM	28480	08642-00098
A17Q1				NOT ASSIGNED		
A17Q2	1853-0526	5	2	TRANSISTOR PNP 2N6437 SI PD=200W	28480	1853-0526
A17Q2	0515-0681	6		SCREW-MACH M3 X 0.5 14MM-LG PAN-HD	28480	0515-0681
A17Q2	0535-0004	9		NUT-HEX DBL-CHAM M3 X 0.5 2.4MM-THK	00000	ORDER BY DESCRIPTION
A17Q2	2190-0584	0		WASHER-LK HLCL 3.0 MM 3.1-MM-ID	28480	2190-0584
A17Q2	1200-0043	8	8	INSULATOR-XSTR ALUMINUM	28480	1200-0043
A17Q2	1200-0081	4	10	INSULATOR-FLG-BSHG NYLON	28480	1200-0081
A17Q3	1854-0637	1		TRANSISTOR NPN 2N2219A SI TO-5 PD=800MW	01295	2N2219A
A17Q3	1200-0173	5		INSULATOR-XSTR DAP-GL	28480	1200-0173
A17Q3	1205-0361	3		HEAT SINK SGL TO-5/TO-39-CS	13103	2226C
A17Q4	1884-0273	4	3	THYRISTOR-SCR 2N4101 TO-66	3L585	2N4101
A17Q4	0340-0162	7	4	INSULATOR-XSTR ALUMINUM	28480	0340-0162
A17Q4	0515-0655	4		SCREW-MACH M3 X 0.5 8MM-LG PAN-HD	00000	ORDER BY DESCRIPTION
A17Q4	0535-0004	9		NUT-HEX DBL-CHAM M3 X 0.5 2.4MM-THK	00000	ORDER BY DESCRIPTION
A17Q4	2190-0584	0		WASHER-LK HLCL 3.0 MM 3.1-MM-ID	28480	2190-0584
A17Q5	1854-0741	8	2	TRANSISTOR NPN 2N6338 SI PD=200W	04713	2N6338
A17Q5	0515-0681	6		SCREW-MACH M3 X 0.5 14MM-LG PAN-HD	28480	0515-0681
A17Q5	0535-0004	9		NUT-HEX DBL-CHAM M3 X 0.5 2.4MM-THK	00000	ORDER BY DESCRIPTION
A17Q5	2190-0584	0		WASHER-LK HLCL 3.0 MM 3.1-MM-ID	28480	2190-0584
A17Q5	1200-0043	8		INSULATOR-XSTR ALUMINUM	28480	1200-0043
A17Q5	1200-0081	4		INSULATOR-FLG-BSHG NYLON	28480	1200-0081
A17Q6	1853-0314	9	3	TRANSISTOR PNP 2N2905A SI TO-39 PD=600MW	04713	2N2905A
A17Q6	1200-0173	5		INSULATOR-XSTR DAP-GL	28480	1200-0173
A17Q7	1884-0273	4		THYRISTOR-SCR 2N4101 TO-66	3L585	2N4101
A17Q7	0340-0162	7		INSULATOR-XSTR ALUMINUM	28480	0340-0162
A17Q7	0515-0655	4		SCREW-MACH M3 X 0.5 8MM-LG PAN-HD	00000	ORDER BY DESCRIPTION
A17Q7	0535-0004	9		NUT-HEX DBL-CHAM M3 X 0.5 2.4MM-THK	00000	ORDER BY DESCRIPTION
A17Q7	2190-0584	0		WASHER-LK HLCL 3.0 MM 3.1-MM-ID	28480	2190-0584
A17Q8	1853-0526	5		TRANSISTOR PNP 2N6437 SI PD=200W	28480	1853-0526
A17Q8	0515-0681	6		SCREW-MACH M3 X 0.5 14MM-LG PAN-HD	28480	0515-0681
A17Q8	0535-0004	9		NUT-HEX DBL-CHAM M3 X 0.5 2.4MM-THK	00000	ORDER BY DESCRIPTION
A17Q8	2190-0584	0		WASHER-LK HLCL 3.0 MM 3.1-MM-ID	28480	2190-0584
A17Q8	1200-0043	8		INSULATOR-XSTR ALUMINUM	28480	1200-0043
A17Q8	1200-0081	4		INSULATOR-FLG-BSHG NYLON	28480	1200-0081
A17Q9	1854-0637	1		TRANSISTOR NPN 2N2219A SI TO-5 PD=800MW	01295	2N2219A
A17Q9	1200-0173	5		INSULATOR-XSTR DAP-GL	28480	1200-0173
A17Q9	1205-0361	3		HEAT SINK SGL TO-5/TO-39-CS	13103	2226C
A17Q10	1884-0065	2	1	THYRISTOR-SCR 2N3670 TO-3 VRRM=400	3L585	2N3670
A17Q10	0515-0655	4		SCREW-MACH M3 X 0.5 8MM-LG PAN-HD	00000	ORDER BY DESCRIPTION
A17Q10	0535-0004	9		NUT-HEX DBL-CHAM M3 X 0.5 2.4MM-THK	00000	ORDER BY DESCRIPTION
A17Q10	2190-0584	0		WASHER-LK HLCL 3.0 MM 3.1-MM-ID	28480	2190-0584
A17Q10	1200-0043	8		INSULATOR-XSTR ALUMINUM	28480	1200-0043
A17Q10	1200-0081	4		INSULATOR-FLG-BSHG NYLON	28480	1200-0081
A17Q11	1854-0741	8		TRANSISTOR NPN 2N6338 SI PD=200W	04713	2N6338
A17Q11	0515-0681	6		SCREW-MACH M3 X 0.5 14MM-LG PAN-HD	28480	0515-0681
A17Q11	0535-0004	9		NUT-HEX DBL-CHAM M3 X 0.5 2.4MM-THK	00000	ORDER BY DESCRIPTION
A17Q11	2190-0584	0		WASHER-LK HLCL 3.0 MM 3.1-MM-ID	28480	2190-0584
A17Q11	1200-0043	8		INSULATOR-XSTR ALUMINUM	28480	1200-0043
A17Q11	1200-0081	4		INSULATOR-FLG-BSHG NYLON	28480	1200-0081

See introduction to this section for ordering information.

\* Indicates factory selected value

Table 6-2. Replaceable Parts

Reference Designation	HP Part Number	C D	Qty	Description	Mfr Code	Mfr Part Number
A17Q12	1853-0314	9		TRANSISTOR PNP 2N2905A SI TO-39 PD=600MW	04713	2N2905A
	1200-0173	5		INSULATOR-XSTR DAP-GL	28480	1200-0173
A17Q13	1884-0273	4		THYRISTOR-SCR 2N4101 TO-66	31585	2N4101
	0340-0162	7		INSULATOR-XSTR ALUMINUM	28480	0340-0162
	0515-0655	4		SCREW-MACH M3 X 0.5 8MM-LG PAN-HD	00000	ORDER BY DESCRIPTION
	0535-0004	9		NUT-HEX DBL-CHAM M3 X 0.5 2.4MM-THK	00000	ORDER BY DESCRIPTION
	2190-0584	0		WASHER-LK HLCL 3.0 MM 3.1-MM-ID	28480	2190-0584
A17Q14	1853-0414	0	1	TRANSISTOR PNP 2N6423 SI TO-66 PD=35W	04713	2N6423
	0340-0162	7		INSULATOR-XSTR ALUMINUM	28480	0340-0162
	0515-0681	6		SCREW-MACH M3 X 0.5 14MM-LG PAN-HD	28480	0515-0681
	0535-0004	9		NUT-HEX DBL-CHAM M3 X 0.5 2.4MM-THK	00000	ORDER BY DESCRIPTION
	2190-0584	0		WASHER-LK HLCL 3.0 MM 3.1-MM-ID	28480	2190-0584
A17Q15	1853-0462	8		TRANSISTOR PNP 2N3635 SI TO-39 PD=1W	01295	2N3635
	1200-0173	5		INSULATOR-XSTR DAP-GL	28480	1200-0173
A17Q16	1854-0813	5		TRANSISTOR NPN 2N3501S SI TO-39 PD=1W	28480	1854-0813
	1200-0173	5		INSULATOR-XSTR DAP-GL	28480	1200-0173
A17Q17	1854-0474	4		TRANSISTOR NPN SI PD=310MW FT=100MHZ	04713	2N5551
A17Q18	1854-0810	2		TRANSISTOR NPN SI PD=625MW FT=200MHZ	28480	1854-0810
A17Q19	1884-0244	9	1	THYRISTOR-SCR VRRM=400	31585	S2600D
	1200-0173	5		INSULATOR-XSTR DAP-GL	28480	1200-0173
A17Q20-Q100				NOT ASSIGNED		
A17Q101	1853-0314	9		TRANSISTOR PNP 2N2905A SI TO-39 PD=600MW	04713	2N2905A
	1200-0173	5		INSULATOR-XSTR DAP-GL	28480	1200-0173
A17R1-R5				NOT ASSIGNED		
A17R6	0698-7236	7		RESISTOR 1K 1% .05W F TC=0+-100	24546	C3-1/8-T0-1001-F
A17R7	0698-3394	0	1	RESISTOR 31.6 1% .5W F TC=0+-100	28480	0698-3394
A17R8	0698-7229	8		RESISTOR 511 1% .05W F TC=0+-100	24546	C3-1/8-T0-511R-F
A17R9	0698-4632	1	2	RESISTOR 1.96K 1% .25W F TC=0+-100	24546	C5-1/4-T0-1961-F
A17R10	0757-0442	9		RESISTOR 10K 1% .125W F TC=0+-100	24546	C4-1/8-T0-1002-F
A17R11	0757-0338	2		RESISTOR 1K 1% .25W F TC=0+-100	24546	C5-1/4-T0-1001-F
A17R12	0757-0728	4	1	RESISTOR 619 1% .25W F TC=0+-100	24546	C5-1/4-T0-619R-F
A17R13	0698-7252	7		RESISTOR 4.64K 1% .05W F TC=0+-100	24546	C3-1/8-T0-4641-F
A17R14	0698-7253	8		RESISTOR 5.11K 1% .05W F TC=0+-100	24546	C3-1/8-T0-5111-F
A17R15	0698-7224	3		RESISTOR 316 1% .05W F TC=0+-100	24546	C3-1/8-T0-316R-F
A17R16	0698-7233	4		RESISTOR 750 1% .05W F TC=0+-100	24546	C3-1/8-T0-750R-F
A17R17	0699-1076	3	2	RESISTOR 7.8K .1% .1W F TC=0+-5	28480	0699-1076
A17R18	2100-3095	5	3	RESISTOR-TMR 200 10% C SIDE-ADJ 17-TRN	02111	43P201
A17R19	0699-1304	0	2	RESISTOR 5.62K .1% .1W F TC=0+-5	28480	0699-1304
A17R20	0698-7280	1		RESISTOR 68.1K 1% .05W F TC=0+-100	24546	C3-1/8-T0-6812-F
A17R21	0698-7264	1		RESISTOR 14.7K 1% .05W F TC=0+-100	24546	C3-1/8-T0-1472-F
A17R22	0698-7215	2		RESISTOR 133 1% .05W F TC=0+-100	24546	C3-1/8-T0-133R-F
A17R23	0812-0111	7	1	RESISTOR .05 3% 3W PW TC=0+-90	28480	0812-0111
A17R24	0698-7205	0		RESISTOR 51.1 1% .05W F TC=0+-100	24546	C3-1/8-T0-51R1-F
A17R25	0698-7212	9		RESISTOR 100 1% .05W F TC=0+-100	24546	C3-1/8-T0-100R-F
A17R26	0698-7229	8		RESISTOR 511 1% .05W F TC=0+-100	24546	C3-1/8-T0-511R-F
A17R27	0698-4632	1		RESISTOR 1.96K 1% .25W F TC=0+-100	24546	C5-1/4-T0-1961-F
A17R28	0698-7260	7		RESISTOR 10K 1% .05W F TC=0+-100	24546	C3-1/8-T0-1002-F
A17R29	0757-0730	8		RESISTOR 750 1% .25W F TC=0+-100	24546	C5-1/4-T0-751-F
A17R30	0757-0338	2		RESISTOR 1K 1% .25W F TC=0+-100	24546	C5-1/4-T0-1001-F
A17R31	0698-7252	7		RESISTOR 4.64K 1% .05W F TC=0+-100	24546	C3-1/8-T0-4641-F
A17R32	0698-7253	8		RESISTOR 5.11K 1% .05W F TC=0+-100	24546	C3-1/8-T0-5111-F
A17R33	0698-7224	3		RESISTOR 316 1% .05W F TC=0+-100	24546	C3-1/8-T0-316R-F
A17R34	0698-7233	4		RESISTOR 750 1% .05W F TC=0+-100	24546	C3-1/8-T0-750R-F
A17R35	0699-1076	3		RESISTOR 7.8K .1% .1W F TC=0+-5	28480	0699-1076
A17R36	2100-3095	5		RESISTOR-TMR 200 10% C SIDE-ADJ 17-TRN	02111	43P201
A17R37	0699-1304	0		RESISTOR 5.62K .1% .1W F TC=0+-5	28480	0699-1304
A17R38	0698-7280	1		RESISTOR 68.1K 1% .05W F TC=0+-100	24546	C3-1/8-T0-6812-F
A17R39	0698-7264	1		RESISTOR 14.7K 1% .05W F TC=0+-100	24546	C3-1/8-T0-1472-F
A17R40	0698-7213	0		RESISTOR 110 1% .05W F TC=0+-100	24546	C3-1/8-T0-110R-F
A17R41	0811-3470	5	2	RESISTOR .1 3% 3W PW TC=0+-90	28480	0811-3470
A17R42	0698-7205	0		RESISTOR 51.1 1% .05W F TC=0+-100	24546	C3-1/8-T0-51R1-F
A17R43	0698-3389	3	1	RESISTOR 17.8 1% .5W F TC=0+-100	28480	0698-3389
A17R44	0698-7228	7		RESISTOR 464 1% .05W F TC=0+-100	24546	C3-1/8-T0-464R-F

See introduction to this section for ordering information.

\* Indicates factory selected value

Table 6-2. Replaceable Parts

Reference Designation	HP Part Number	C D	Qty	Description	Mfr Code	Mfr Part Number
A17R45	0698-7248	1		RESISTOR 3.16K 1% .05W F TC=0+-100	24546	C3-1/8-T0-3161-F
A17R46				NOT ASSIGNED		
A17R47	0698-3453	2		RESISTOR 196K 1% .125W F TC=0+-100	24546	C4-1/8-T0-1963-F
A17R48	0698-7264	1		RESISTOR 14.7K 1% .05W F TC=0+-100	24546	C3-1/8-T0-1472-F
A17R49	0698-7216	3		RESISTOR 147 1% .05W F TC=0+-100	24546	C3-1/8-T0-147R-F
A17R50	0811-3511	5	1	RESISTOR .01 1% 2W PWW TC=0+-150	28480	0811-3511
A17R51	0757-1001	8	1	RESISTOR 56.2 1% .5W F TC=0+-100	28480	0757-1001
A17R52	0698-3440	7		RESISTOR 196 1% .125W F TC=0+-100	24546	C4-1/8-T0-196R-F
A17R53	2100-3123	0	2	RESISTOR-TRMR 500 10% C SIDE-ADJ 17-TRN	02111	43P501
A17R54	0699-1305	1	2	RESISTOR 10.2K .1% .1W F TC=0+-5	28480	0699-1305
A17R55	0698-7203	8		RESISTOR 42.2 1% .05W F TC=0+-100	24546	C3-1/8-T0-42R2-F
A17R56	0757-0400	9	1	RESISTOR 90.9 1% .125W F TC=0+-100	24546	C4-1/8-T0-90R9-F
A17R57	0698-7236	7		RESISTOR 1K 1% .05W F TC=0+-100	24546	C3-1/8-T0-1001-F
A17R58	0698-7260	7		RESISTOR 10K 1% .05W F TC=0+-100	24546	C3-1/8-T0-1002-F
A17R59	0698-7236	7		RESISTOR 1K 1% .05W F TC=0+-100	24546	C3-1/8-T0-1001-F
A17R60	0698-3453	2		RESISTOR 196K 1% .125W F TC=0+-100	24546	C4-1/8-T0-1963-F
A17R61	0698-7264	1		RESISTOR 14.7K 1% .05W F TC=0+-100	24546	C3-1/8-T0-1472-F
A17R62	0698-7228	7		RESISTOR 464 1% .05W F TC=0+-100	24546	C3-1/8-T0-464R-F
A17R63	0811-3470	5		RESISTOR .1 3% 3W PW TC=0+-90	28480	0811-3470
A17R64	0698-7521	3	1	RESISTOR 5.1 5% .25W F TC=0+-100	11502	TF07-1/4-T0-5R1-J
A17R65	0698-7276	5		RESISTOR 46.4K 1% .05W F TC=0+-100	24546	C3-1/8-T0-4642-F
A17R66	2100-3123	0		RESISTOR-TRMR 500 10% C SIDE-ADJ 17-TRN	02111	43P501
A17R67	0699-1305	1		RESISTOR 10.2K .1% .1W F TC=0+-5	28480	0699-1305
A17R68	0698-7203	8		RESISTOR 42.2 1% .05W F TC=0+-100	24546	C3-1/8-T0-42R2-F
A17R69	0698-7260	7		RESISTOR 10K 1% .05W F TC=0+-100	24546	C3-1/8-T0-1002-F
A17R70	0698-7260	7		RESISTOR 10K 1% .05W F TC=0+-100	24546	C3-1/8-T0-1002-F
A17R71	0698-7238	9		RESISTOR 1.21K 1% .05W F TC=0+-100	24546	C3-1/8-T0-1211-F
A17R72	0757-0442	9		RESISTOR 10K 1% .125W F TC=0+-100	24546	C4-1/8-T0-1002-F
A17R73	0698-7260	7		RESISTOR 10K 1% .05W F TC=0+-100	24546	C3-1/8-T0-1002-F
A17R74	0757-0984	4	1	RESISTOR 10 1% .5W F TC=0+-100	28480	0757-0984
A17R75	0699-1306	2	1	RESISTOR 42.2K .1% .1W F TC=0+-5	28480	0699-1306
A17R76	2100-3095	5		RESISTOR-TRMR 200 10% C SIDE-ADJ 17-TRN	02111	43P201
A17R77	0699-1476	7	1	RESISTOR 6K .1% .1W F TC=0+-5	28480	0699-1476
A17R78	0698-7272	1		RESISTOR 31.6K 1% .05W F TC=0+-100	24546	C3-1/8-T0-3162-F
A17R79	0757-0729	5	1	RESISTOR 681 1% .25W F TC=0+-100	24546	C5-1/4-T0-681R-F
A17R80	0698-7236	7		RESISTOR 1K 1% .05W F TC=0+-100	24546	C3-1/8-T0-1001-F
A17R81	0699-1307	3	2	RESISTOR 1.96K .1% .1W F TC=0+-5	28480	0699-1307
A17R82	0699-1307	3		RESISTOR 1.96K .1% .1W F TC=0+-5	28480	0699-1307
A17R83	0698-7236	7		RESISTOR 1K 1% .05W F TC=0+-100	24546	C3-1/8-T0-1001-F
2427A TO 2531A A17R84				NOT ASSIGNED		
2533A AND ABOVE A17R84	0698-7236	7		RESISTOR 1K 1% F TC=0+-100	28480	C3-1/8-T0-1001-F
2427A TO 2647A A17R85-R100				NOT ASSIGNED		
2709A AND ABOVE A17R85	0698-7228	7		RESISTOR 464 1% .05W F TC=0+-100	24546	C3-1/8-T0-464R-F
A17R86	0698-7228	7		RESISTOR 464 1% .05W F TC=0+-100	24546	C3-1/8-T0-464R-F
A17R87	0698-7228	7		RESISTOR 464 1% .05W F TC=0+-100	24546	C3-1/8-T0-464R-F
A17R88	0698-7228	7		RESISTOR 464 1% .05W F TC=0+-100	24546	C3-1/8-T0-464R-F
A17R89	0698-7228	7		RESISTOR 464 1% .05W F TC=0+-100	24546	C3-1/8-T0-464R-F
A17R90-R100				NOT ASSIGNED		
A17R101	0698-3449	6		RESISTOR 28.7K 1% .125W F TC=0+-100	24546	C4-1/8-T0-2872-F
A17R102	0757-0460	1	1	RESISTOR 61.9K 1% .125W F TC=0+-100	24546	C4-1/8-T0-6192-F
A17R103	0757-0464	5	1	RESISTOR 90.9K 1% .125W F TC=0+-100	24546	C4-1/8-T0-9092-F
A17R104	0698-3243	8	1	RESISTOR 178K 1% .125W F TC=0+-100	24546	C4-1/8-T0-1783-F
A17R105	0757-0442	9		RESISTOR 10K 1% .125W F TC=0+-100	24546	C4-1/8-T0-1002-F
A17R106	0757-0438	3		RESISTOR 5.11K 1% .125W F TC=0+-100	24546	C4-1/8-T0-5111-F
A17R107	0698-0442	9		RESISTOR 10K 1% .125W F TC=0+-100	24546	C4-1/8-T0-1002-F
A17R108	0698-0083	8		RESISTOR 1.96K 1% .125W F TC=0+-100	24546	C4-1/8-T0-1961-F
A17R109	0757-0280	3		RESISTOR 1K 1% .125W F TC=0+-100	24546	C4-1/8-T0-1001-F
A17R110				NOT ASSIGNED		
A17R111				NOT ASSIGNED		
A17R112	0698-8958	2		RESISTOR 511K 1% .125W F TC=0+-100	28480	0698-8958
2427A TO 2507A A17R113	0698-3161	9	1	RESISTOR 38.3K 1% .125W F TC=0+-100	24546	C4-1/8-T0-3832-F
A17R114	0757-0461	2	1	RESISTOR 68.1K 1% .125W F TC=0+-100	24546	C4-1/8-T0-6812-F
2509A AND ABOVE A17R113	0757-0459	8	1	RESISTOR 56.2K 1% .125W F TC=0+-100	24546	C4-1/8-T0-5622-F
A17R114	0757-0463	4	1	RESISTOR 82.5K 1% .125W F TC=0+-100	24546	C4-1/8-T0-8252-F
A17R115	0757-0462	3		RESISTOR 75K 1% .125W F TC=0+-100	24546	C4-1/8-T0-7502-F

See introduction to this section for ordering information.

\* Indicates factory selected value

Table 6-2. Replaceable Parts

Reference Designation	HP Part Number	C D	Qty	Description	Mfr Code	Mfr Part Number
2427A TO 2507A A17R116	0757-0463	4	1	RESISTOR 82.5K 1% .125W F TC=0+-100	24546	C4-1/8-T0-8252-F
2509A AND ABOVE A17R116	0757-0459	8		RESISTOR 56.2K 1% .125W F TC=0+-100	24546	C4-1/8-T0-5622-F
A17R117	0757-0280	3		RESISTOR 1K 1% .125W F TC=0+-100	24546	C4-1/8-T0-1001-F
A17R118	0757-0280	3		RESISTOR 1K 1% .125W F TC=0+-100	24546	C4-1/8-T0-1001-F
A17TP1	0360-0535	0		TERMINAL TEST POINT PCB	00000	ORDER BY DESCRIPTION
A17TP2	0360-0535	0		TERMINAL TEST POINT PCB	00000	ORDER BY DESCRIPTION
A17TP3	0360-0535	0		TERMINAL TEST POINT PCB	00000	ORDER BY DESCRIPTION
A17TP4	0360-0535	0		TERMINAL TEST POINT PCB	00000	ORDER BY DESCRIPTION
A17TP5	0360-0535	0		TERMINAL TEST POINT PCB	00000	ORDER BY DESCRIPTION
A17TP6	0360-0535	0		TERMINAL TEST POINT PCB	00000	ORDER BY DESCRIPTION
2427A TO 2709A A17U1	1826-0989	7		IC OP AMP GP 8-DIP-C PKG	28480	1826-0989
A17U2	1826-0989	8		IC OP AMP GP 8-DIP-C PKG	28480	1826-0989
2808A AND ABOVE A17U1	1826-0043	4		IC OP AMP GP T0-99 PKG	3L585	CA307T
A17U2	1826-0043	4		IC OP AMP GP T0-99 PKG	3L585	CA307T
A17U3	1826-0323	3	2	IC OP AMP GP QUAD 14-DIP-C PKG	28480	1826-0323
A17U4	1826-0323	3		IC OP AMP GP QUAD 14-DIP-C PKG	28480	1826-0323
A17U5-U100				NOT ASSIGNED		
A17U101	1820-1199	1	2	IC INV TTL LS HEX 1-INP	01295	SN74LS04N
A17U102	1820-1199	1		IC INV TTL LS HEX 1-INP	01295	SN74LS04N
A17U104	1820-2686	3	5	IC GATE TTL F AND QUAD 2-INP	07263	74F08PC
A17U105	1820-2686	3		IC GATE TTL F AND QUAD 2-INP	07263	74F08PC
A17U106	1820-2686	3		IC GATE TTL F AND QUAD 2-INP	07263	74F08PC
A17U107	1820-2686	3		IC GATE TTL F AND QUAD 2-INP	07263	74F08PC
A17U108				NOT ASSIGNED		
A17U109				NOT ASSIGNED		
A17U110	1820-2111	9	4	IC DRVR TTL INV	01295	SN75468N
A17U111	1820-2111	9		IC DRVR TTL INV	01295	SN75468N
A17U112	1820-2111	9		IC DRVR TTL INV	01295	SN75468N
A17U113	1820-2111	9		IC DRVR TTL INV	01295	SN75468N
A17U114	1820-1437	0		IC MV TTL LS MONOSTBL DUAL	01295	SN74LS221N
A17U115	1820-1437	0		IC MV TTL LS MONOSTBL DUAL	01295	SN74LS221N
A17U116	1820-2686	3		IC GATE TTL F AND QUAD 2-INP	07263	74F08PC
A17U117	1820-2273	4		IC DRVR TTL OCTL	13606	UDN2981A
A17U118	1826-0026	3		IC COMPARATOR PRCN T0-99 PKG	01295	LM311L
A17U119	1820-1212	9		IC FF TTL LS J-K NEG-EDGE-TRIG	01295	SN74LS112AN
A17U120	1820-1144	6		IC GATE TTL LS NOR QUAD 2-INP	01295	SN74LS02N
A17U121	1820-1437	0		IC MV TTL LS MONOSTBL DUAL	01295	SN74LS221N
A17VR1	1902-0963	9	2	DIODE-ZNR 16V 5% D0-35 PD=.4W TC=+.088%	28480	1902-0963
A17VR2	1902-0960	6	2	DIODE-ZNR 12V 5% D0-35 PD=.4W TC=+.077%	28480	1902-0960
A17VR3	1902-0692	1		DIODE-ZNR 6.3V 1% D0-7 PD=.4W TC=+.001%	28480	1902-0692
A17VR4	1902-0963	9		DIODE-ZNR 16V 5% D0-35 PD=.4W TC=+.088%	28480	1902-0963
A17VR5	1902-0960	6		DIODE-ZNR 12V 5% D0-35 PD=.4W TC=+.077%	28480	1902-0960
A17VR6	1902-0692	1		DIODE-ZNR 6.3V 1% D0-7 PD=.4W TC=+.001%	28480	1902-0692
A17VR7	1902-0952	6	2	DIODE-ZNR 5.6V 5% D0-35 PD=.4W TC=+.046%	28480	1902-0952
A17VR8	1902-0943	5		DIODE-ZNR 2.4V 5% D0-35 PD=.4W TC=-.037%	28480	1902-0943
A17VR9	1902-0952	6		DIODE-ZNR 5.6V 5% D0-35 PD=.4W TC=+.046%	28480	1902-0952
A17VR10	1902-0943	5		DIODE-ZNR 2.4V 5% D0-35 PD=.4W TC=-.037%	28480	1902-0943
A17VR11	1902-3333	3	1	DIODE-ZNR 46.4V 5% D0-35 PD=.4W	28480	1902-3333
A17VR12	1902-3357	1	1	DIODE-ZNR 56.2V 5% D0-7 PD=.4W TC=+.081%	28480	1902-3357
A17VR101	1902-0953	7		DIODE-ZNR 6.2V 5% D0-35 PD=.4W TC=+.053%	28480	1902-0953
A17VR102	1902-1412	5	1	DIODE-ZNR 39V 5% D0-35 PD=.4W TC=+.113%	28480	1902-1412
A17W1	1251-4670	2		CONNECTOR 3-PIN M POST TYPE	28480	1251-4670
A17W2	1258-0209	9	5	JUMPER-REMOVABLE 2 POSITION; .200 IN	28480	1258-0209
A17W3	1251-5380	3	2	CONNECTOR 2-PIN M POST TYPE	28480	1251-5380
A17W4	1258-0209	9		JUMPER-REMOVABLE 2 POSITION; .200 IN	28480	1258-0209
A17W5	1251-5380	3		CONNECTOR 2-PIN M POST TYPE	28480	1251-5380
A17W6	1258-0209	9		JUMPER-REMOVABLE 2 POSITION; .200 IN	28480	1258-0209

See introduction to this section for ordering information.

\* Indicates factory selected value





Table 6-2. Replaceable Parts

Reference Designation	HP Part Number	C D	Qty	Description	Mfr Code	Mfr Part Number
<b>A18</b>						
A18	08642-60844	4	1	POWER SUPPLY RECTIFIER/FILTER MODULE	28480	08642-60844
A18	08642-69844	2	1	POWER SUPPLY RECTIFIERS/FILTERS MODULE (RESTORED)	28480	08642-69844
A18C1	0180-2969	6	1	CAPACITOR-FXD .02F+75-10% 40VDC AL	56289	36DX203G040BC2A
	2190-0011	8	5	WASHER-LK INTL T NO. 10 .195-IN-ID	28480	2190-0011
	2680-0129	8	10	SCREW-MACH 10-32 .312-IN-LG PAN-HD-POZI	00000	ORDER BY DESCRIPTION
A18C2	0180-3042	8	1	CAPACITOR-FXD .012F+75-10% 40VDC AL	28480	0180-3042
	2190-0011	8		WASHER-LK INTL T NO. 10 .195-IN-ID	28480	2190-0011
	2680-0129	8		SCREW-MACH 10-32 .312-IN-LG PAN-HD-POZI	00000	ORDER BY DESCRIPTION
A18C3	0180-3017	7	1	CAPACITOR-FXD .045F+75-10% 25VDC AL	28480	0180-3017
	2190-0011	8		WASHER-LK INTL T NO. 10 .195-IN-ID	28480	2190-0011
	2680-0129	8		SCREW-MACH 10-32 .312-IN-LG PAN-HD-POZI	00000	ORDER BY DESCRIPTION
A18C4	0180-2671	7	1	CAPACITOR-FXD .012F+75-10% 30VDC AL	00853	500123U030AC2A
	2190-0011	8		WASHER-LK INTL T NO. 10 .195-IN-ID	28480	2190-0011
	2680-0129	8		SCREW-MACH 10-32 .312-IN-LG PAN-HD-POZI	00000	ORDER BY DESCRIPTION
A18C5	0180-2316	7	1	CAPACITOR-FXD 900UF+50-10% 100VDC AL	28480	0180-2316
	2190-0011	8		WASHER-LK INTL T NO. 10 .195-IN-ID	28480	2190-0011
	2680-0129	8		SCREW-MACH 10-32 .312-IN-LG PAN-HD-POZI	00000	ORDER BY DESCRIPTION
A18C6	0160-5559	4	2	CAPACITOR-FXD .82UF +-5% 100VDC	28480	0160-5559
A18C7	0160-5559	4		CAPACITOR-FXD .82UF +-5% 100VDC	28480	0160-5559
A18C8	0180-0291	3		CAPACITOR-FXD 1UF+-10% 35VDC TA	56289	150D105X9035A2
A18C9	0180-0291	3		CAPACITOR-FXD 1UF+-10% 35VDC TA	56289	150D105X9035A2
A18CR1	1906-0231	2	2	DIODE-CT-RECT 200V 15A	28480	1906-0231
	0515-1084	5	4	SCREW-MACH M3 X 0.5 12MM-LG PAN-HD	28480	0515-1084
	0535-0004	9		NUT-HEX DBL-CHAM M3 X 0.5 2.4MM-THK	00000	ORDER BY DESCRIPTION
	1200-0043	8		INSULATOR-XSTR ALUMINUM	28480	1200-0043
	1200-0081	4		INSULATOR-FLG-BSHG NYLON	28480	1200-0081
	2190-0584	0		WASHER-LK HLCL 3.0 MM 3.1-MM-ID	28480	2190-0584
	08642-00038	2	3	HEAT SINK RECTI	28480	08642-00038
A18CR2	1901-0418	7	4	DIODE-PWR RECT 400V 1.5A	28480	1901-0418
A18CR3	1901-0418	7		DIODE-PWR RECT 400V 1.5A	28480	1901-0418
A18CR4	1906-0231	2		DIODE-CT-RECT 200V 15A	28480	1906-0231
	0515-1084	5		SCREW-MACH M3 X 0.5 12MM-LG PAN-HD	28480	0515-1084
	0535-0004	9		NUT-HEX DBL-CHAM M3 X 0.5 2.4MM-THK	00000	ORDER BY DESCRIPTION
	1200-0043	8		INSULATOR-XSTR ALUMINUM	28480	1200-0043
	1200-0081	4		INSULATOR-FLG-BSHG NYLON	28480	1200-0081
	2190-0584	0		WASHER-LK HLCL 3.0 MM 3.1-MM-ID	28480	2190-0584
	08642-00038	2		HEAT SINK RECTI	28480	08642-00038
A18CR5	1901-0418	7		DIODE-PWR RECT 400V 1.5A	28480	1901-0418
A18CR6	1901-0418	7		DIODE-PWR RECT 400V 1.5A	28480	1901-0418
A18CR7	1901-0028	5		DIODE-PWR RECT 400V 750MA DO-29	28480	1901-0028
A18CR8	1901-0028	5		DIODE-PWR RECT 400V 750MA DO-29	28480	1901-0028
A18CR9	1901-0028	5		DIODE-PWR RECT 400V 750MA DO-29	28480	1901-0028
A18CR10	1901-0028	5		DIODE-PWR RECT 400V 750MA DO-29	28480	1901-0028
A18CR11	1901-0050	3		DIODE-SWITCHING 80V 200MA 2NS DO-35	28480	1901-0050
A18CR12	1901-0028	5		DIODE-PWR RECT 400V 750MA DO-29	28480	1901-0028
A18F1	2110-0010	9	1	FUSE 5A 250V NTD 1.25X.25 UL	75915	312005
	2110-0643	4	5	FUSEHOLDER-CLIP TYPE 15A 250 V	28480	2110-0643
<i>2427A TO 2734A A18F2</i>	2110-0002	9	2	FUSE 2A 250V NTD 1.25X.25 UL	75915	312005
<i>2738A AND ABOVE A18F2</i>	2110-0303	3	1	FUSE 2A 250V TD 1.25X.25 UL	28480	2110-0303
	2110-0643	4		FUSEHOLDER-CLIP TYPE 15A 250 V	28480	2110-0643
A18F3	2110-0036	9	1	FUSE 8A 125V NTD 1.25X.25 UL	75915	312008
	2110-0643	4		FUSEHOLDER-CLIP TYPE 15A 250 V	28480	2110-0643
A18F4	2110-0002	9		FUSE 2A 250V NTD 1.25X.25 UL	75915	312002
	2110-0643	4		FUSEHOLDER-CLIP TYPE 15A 250 V	28480	2110-0643
A18F5	2110-0004	1	1	FUSE .25A 250V NTD 1.25X.25 UL	28480	2110-0004
	2110-0643	4		FUSEHOLDER-CLIP TYPE 15A 250 V	28480	2110-0643
A18J1	1251-5256	2	1	CONNECTOR 9-PIN M POST TYPE	28480	1251-5256
A18J2	1251-5170	9	1	CONNECTOR 2-PIN M POST TYPE	28480	1251-5170
A18J3	1251-6732	1	1	CONNECTOR 14-PIN M POST TYPE	28480	1251-6732
A18J4	1251-4969	2	1	CONNECTOR 4-PIN M POST TYPE	28480	1251-4969

See introduction to this section for ordering information.

\* Indicates factory selected value

Table 6-2. Replaceable Parts

Reference Designation	HP Part Number	C D	Qty	Description	Mfr Code	Mfr Part Number
A18K1	0490-1427	6	1	RELAY 2C 24VDC-COIL 7.5A 120VAC	28480	0490-1427
A18MP1				NOT ASSIGNED		
A18MP2	08642-00115	6	1	FOAM - 6.4 BFC	28480	08642-00115
A18MP3	08642-00131	6	1	FOAM - 1.6 BFC	28480	08642-00131
A18Q1	1884-0276	7	1	THYRISTOR-TRIAC TO-220AB	28480	1884-0276
	0515-0655	4		SCREW-MACH M3 X 0.5 8MM-LG PAN-HD	00000	ORDER BY DESCRIPTION
	0535-0004	9		NUT-HEX DBL-CHAM M3 X 0.5 2.4MM-THK	00000	ORDER BY DESCRIPTION
	2190-0584	0		WASHER-LK HLCL 3.0 MM 3.1-MM-ID	28480	2190-0584
A18R1	0757-0401	0		RESISTOR 100 1% .125W F TC=0+-100	24546	C4-1/8-T0-101-F
A18R2	0757-1078	9		RESISTOR 1.47K 1% .5W F TC=0+-100	28480	0757-1078
A18R3	0698-4636	5	1	RESISTOR 2.61K 1% .25W F TC=0+-100	24546	C5-1/4-T0-2611-F
A18R4	0757-0730	8		RESISTOR 750 1% .25W F TC=0+-100	24546	C5-1/4-T0-751-F
A18R5	0698-3150	6		RESISTOR 2.37K 1% .125W F TC=0+-100	24546	C4-1/8-T0-2371-F
A18R6	0698-4727	5	1	RESISTOR 21.5K 1% .25W F TC=0+-100	24546	C5-1/4-T0-2152-F
A18R7	0698-7214	1	1	RESISTOR 121 1% .05W F TC=0+-100	24546	C3-1/8-T0-121R-F
A18R8	0757-0274	5		RESISTOR 1.21K 1% .125W F TC=0+-100	24546	C4-1/8-T0-1211-F
A18U1	1826-0523	5	1	IC 337 V RGLTR TO-3	27014	LM337K
	0515-1084	5		SCREW-MACH M3 X 0.5 12MM-LG PAN-HD	28480	0515-1084
	0535-0004	9		NUT-HEX DBL-CHAM M3 X 0.5 2.4MM-THK	00000	ORDER BY DESCRIPTION
	1200-0043	8		INSULATOR-XSTR ALUMINUM	28480	1200-0043
	1200-0081	4		INSULATOR-FLG-BSHG NYLON	28480	1200-0081
	2190-0584	0		WASHER-LK HLCL 3.0 MM 3.1-MM-ID	28480	2190-0584
	08642-00038	2		HEAT SINK RECTI	28480	08642-00038
A18VR1	1902-3381	1	2	DIODE-ZNR 68.1V 5% DO-7 PD=.4W TC=+.079%	28480	1902-3381
A18VR2	1902-3381	1		DIODE-ZNR 68.1V 5% DO-7 PD=.4W TC=+.079%	28480	1902-3381

See introduction to this section for ordering information.

\* Indicates factory selected value

Table 6-2. Replaceable Parts

Reference Designation	Mfr Part Number	C D	Qty	Description	Mfr Code	Mfr Part Number
<b>A19</b>						
A19	08642-60845	5	1	DOUBLER/ATTENUATOR MODULE (8642B ONLY)	28480	08642-60845
A19	08642-6984	3	1	DOUBLER/ATTENUATOR MODULE (8642B ONLY) (RESTRUCTURED)	28480	08642-69845
<i>2427A TO 2708A</i>						
<i>A19AT1</i>	08642-60962	7	1	70 DB ATTENUATOR	28480	08642-60962
<i>A19AT2</i>	08642-60963	8	1	75 DB ATTENUATOR	28480	08642-60963
<i>2709A AND ABOVE</i>						
<i>A19AT1</i>	08642-60291	5	1	70 DB ATTENUATOR	28480	08642-60291
<i>A19AT2</i>	08642-60292	6	1	75 DB ATTENUATOR	28480	08642-60292
<i>2427A TO 2450A</i>						
<i>A19FL1</i>	08642-80013	1		FLTR LP 3M BKT	28480	08642-80013
<i>2708A AND ABOVE</i>						
<i>A19FL1</i>	08642-80094	8		FLTR ASSY 10 PIN	28480	08642-80094
A19K1	3106-0030	5	2	RELAY-COAXIAL LATCHING SPDT; FREQ RANGE	28480	3106-0030
A19K2	3106-0030	5		RELAY-COAXIAL LATCHING SPDT; FREQ RANGE	28480	3106-0030
A19MP1	2200-0109	8	2	SCREW-MACH 4-40 .438-IN-LG PAN-HD-POZI (ATTACH AT1, AT2 BOTTOM TO BASE)	00000	ORDER BY DESCRIPTION
A19MP2	2200-0103	2	2	SCREW-MACH 4-40 .25-IN-LG PAN-HD-POZI (ATTACH AT1, AT2 TOP TO BASE)	28480	2200-0103
A19MP3	08642-20024	8	1	COVER DOUBLER CONTROL	28480	08642-20024
A19MP4	08642-40059	1		GASKET FEEDTHRU	28480	08642-40059
A19MP5	0515-1142	6	2	SCREW-MACH M4 X 0.7 8MM-LG PAN-HD (ATTACH A19A1 TO BASE)	28480	0515-1142
A19MP6	0515-0381	3		SCREW-MACH M4 X 0.7 10MM-LG PAN-HD (ATTACH COVER, A19A2, A19A3 TO BASE)	00000	ORDER BY DESCRIPTION
A19MP7	08642-40025	1	1	COVER DOUBLER RPP	28480	08642-40025
A19MP8	08642-40052	4		GASKET FD/THRU 2	28480	08642-40052
A19MP9	08642-20026	0	1	BASE DOUBLER	28480	08642-20026
A19MP10	08642-00002	0		GASKET 10 P FLTR	28480	08642-00002
A19MP11	0515-1521	5		SCREW-MACH M3 X 0.5 5MM-LG 90-DEG-FLH-HD (ATTACH FILTER TO BASE)	28480	0515-1521
A19MP12	0515-1143	7	2	SCREW-MACH M4 X 0.7 16MM-LG PAN-HD (ATTACH A19A3 TO BASE)	28480	0515-1143
A19MP13	08642-20027	1	1	COVER DOUBLER ALC	28480	08642-20027
A19MP14	3050-0891	7		WASHER-FL MTL 3.0 MM 3.3-MM-ID (FOR A19K1, A19K2 TO BASE)	28480	3050-0891
A19MP15	0515-0682	7	4	SCREW-MACH M3 X 0.5 18MM-LG PAN-HD (ATTACH A19K1, A19K2 TO BASE)	28480	0515-0682
A19MP16	8160-0472	8		REI ROUND STRIP BE-CU SN-PL .093-IN-OD (SPIRA SHIELD)	28480	8160-0472
A19MP17	08642-00049	5		SLIDE-MDL 469R56 (FRONT)	28480	08642-00049
A19MP18	08642-00052	0		SLIDE-MODULE R89 (REAR)	28480	08642-00052
A19MP19	0515-1102	8		SCREW-MACH M3 X 0.5 8MM-LG 90-DEG-FLH-HD (ATTACH MODULE SLIDE TO BASE)	28480	0515-1102
A19MP20	08642-80072	2	1	LABEL-DBLR 60009	28480	08642-80072
<i>2427A TO 2735A</i>						
<i>A19MP21</i>				NOT ASSIGNED		
<i>2748A AND ABOVE</i>						
<i>A19MP21</i>	86701-00017	3	2	DISK FAN SHIELD	28480	86701-00017
A19W1	08642-20055	5	1	CABLE SR SW2-SW3 (A19K1J1 TO A19K2J1)	28480	08642-20055
A19W2	08642-20056	6	1	CABLE SR SW3-A70 (A19K2J2 TO A19AT1J1)	28480	08642-20056
A19W3	08642-20053	3	1	CABLE SR SW2-X2 (A19K1J3 TO A19A3J1)	28480	08642-20053
A19W4	08642-20046	4	1	CABLE SR X2-SW3 (K2J3 TO U2J2)	28480	08642-20046
A19W5	08642-20057	7	1	CABLE SR A70-A75 (A19AT1J2 TO A19AT2J2)	28480	08642-20057
A19W6	08642-20047	5	1	CABLE SR A75-RPP (A19AT2J1 TO A19A2J1)	28480	08642-20047
A19W7	08642-60074	2	1	CBL AY RIBN S.W.H (K1, K2 TO A19A1J4)	28480	08642-60074
A19W8				RIBBON CABLE (A19AT1/AT2 TO A19A1J1) (NOT SEPARATELY REPLACEABLE)		

See introductory section for ordering information

\* Indicates factory selected value

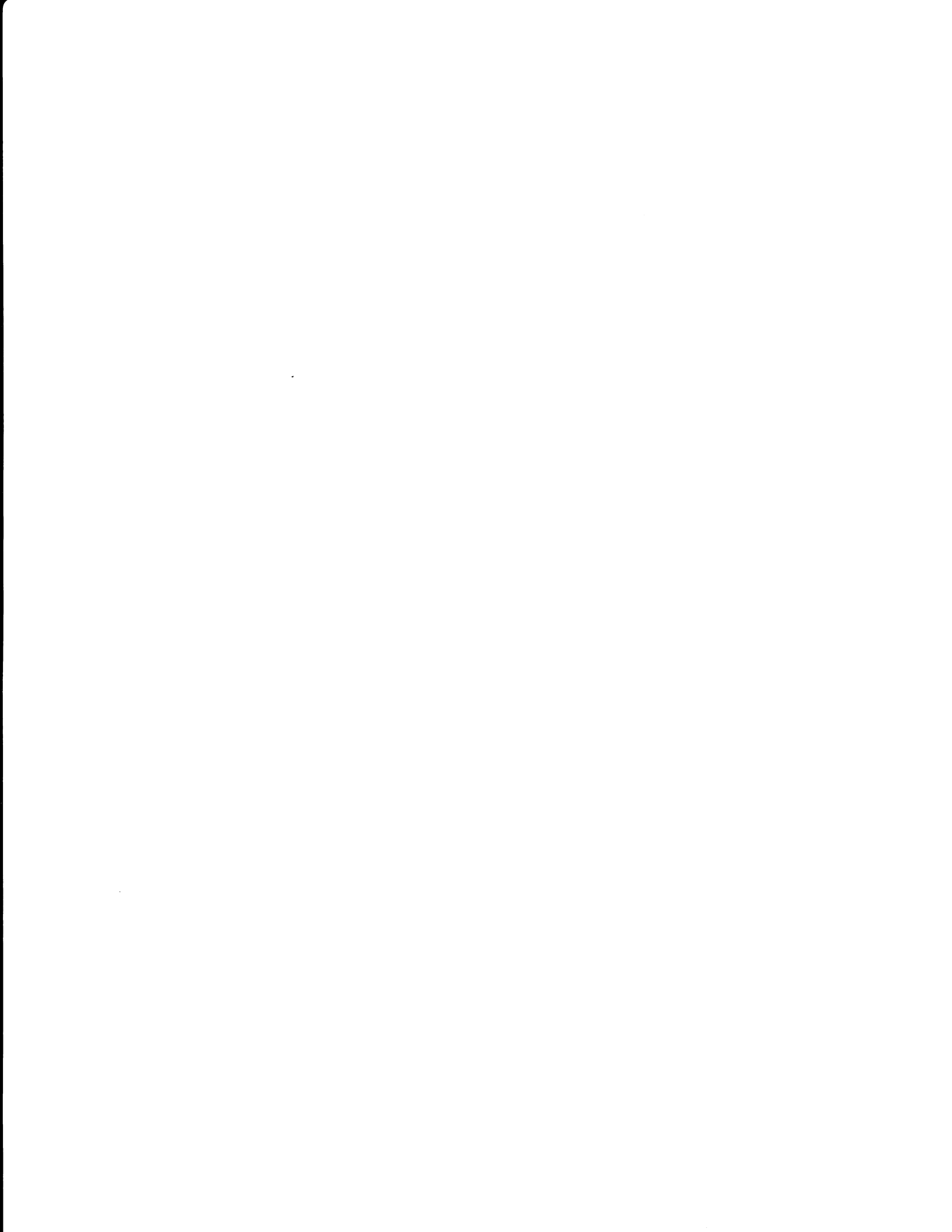

Table 6-2. Replaceable Parts

Reference Designation	HP Part Number	C D	Qty	Description	Mfr Code	Mfr Part Number
2427A TO 2516A A19A1	08642-60118	5	1	DOUBLER CONTROL ASSEMBLY	28480	08642-60118
2517A TO 2637A A19A1	08642-60218	6	1	DOUBLER CONTROL ASSEMBLY	28480	08642-60218
2640A AND ABOVE A19A1	08642-60318	7	1	DOUBLER CONTROL ASSEMBLY	28480	08642-60318
A19A1C1	0180-2853	7	1	CAPACITOR-FXD 10UF+-20% 100VDC TA	56289	109D106X0100C2
A19A1C2	0180-0116	1		CAPACITOR-FXD 6.8UF+-10% 35VDC TA	56289	150D685X9035B2
A19A1C3	0180-0116	1		CAPACITOR-FXD 6.8UF+-10% 35VDC TA	56289	150D685X9035B2
A19A1C4	0180-2620	6		CAPACITOR-FXD 2.2UF+-10% 50VDC TA	25088	D2R2GS1B50K
A19A1C5	0180-2620	6		CAPACITOR-FXD 2.2UF+-10% 50VDC TA	25088	D2R2GS1B50K
A19A1C6	0160-4835	7		CAPACITOR-FXD .1UF +-10% 50VDC CER	28480	0160-4835
A19A1C7	0160-0576	5		CAPACITOR-FXD .1UF +-20% 50VDC CER	28480	0160-0576
A19A1C8	0160-4835	7		CAPACITOR-FXD .1UF +-10% 50VDC CER	28480	0160-4835
A19A1C9	0160-0576	5		CAPACITOR-FXD .1UF +-20% 50VDC CER	28480	0160-0576
A19A1C10	0160-4835	7		CAPACITOR-FXD .1UF +-10% 50VDC CER	28480	0160-4835
A19A1C11	0160-4835	7		CAPACITOR-FXD .1UF +-10% 50VDC CER	28480	0160-4835
A19A1C12	0160-4835	7		CAPACITOR-FXD .1UF +-10% 50VDC CER	28480	0160-4835
2427A TO 2637A A19A1C13	0160-4791	4		CAPACITOR-FXD 10PF +-5% 100VDC CER 0+-30	28480	0160-4791
2640A AND ABOVE A19A1C13				NOT ASSIGNED		
A19A1C14	0160-4835	7		CAPACITOR-FXD .1UF +-10% 50VDC CER	28480	0160-4835
A19A1C15	0160-4835	7		CAPACITOR-FXD .1UF +-10% 50VDC CER	28480	0160-4835
2427A TO 2516A A19A1C16	0160-4835	7		CAPACITOR-FXD .1UF +-10% 50VDC CER	28480	0160-4835
2517A AND ABOVE A19A1C16	0160-4834	6		CAPACITOR-FXD .047UF +-10% 100VDC CER	28480	0160-4834
A19A1C17				NOT ASSIGNED		
A19A1C18	0160-4835	7		CAPACITOR-FXD .1UF +-10% 50VDC CER	28480	0160-4835
A19A1C19	0160-4835	7		CAPACITOR-FXD .1UF +-10% 50VDC CER	28480	0160-4835
A19A1C20	0160-4835	7		CAPACITOR-FXD .1UF +-10% 50VDC CER	28480	0160-4835
A19A1C21	0160-4835	7		CAPACITOR-FXD .1UF +-10% 50VDC CER	28480	0160-4835
A19A1C22	0160-3324	7		CAPACITOR-FXD 1UF +-5% 100VDC MET-POLYC	28480	0160-3324
A19A1C23	0160-4371	6		CAPACITOR-FXD 680PF +-5% 100VDC CER	28480	0160-4371
A19A1C24	0160-4788	9	1	CAPACITOR-FXD 18PF +-5% 100VDC CER 0+-30	28480	0160-4788
A19A1C25	0160-4807	3	1	CAPACITOR-FXD 33PF +-5% 100VDC CER 0+-30	28480	0160-4807
A19A1C26	0160-4519	4	1	CAPACITOR-FXD 9.1PF +- .5PF 200VDC CER	28480	0160-4519
A19A1C27	0180-0491	5		CAPACITOR-FXD 10UF+-20% 25VDC TA	28480	0180-0491
A19A1C28	0160-4835	7		CAPACITOR-FXD .1UF +-10% 50VDC CER	28480	0160-4835
A19A1C29	0160-4835	7		CAPACITOR-FXD .1UF +-10% 50VDC CER	28480	0160-4835
2427A TO 2516A A19A1C30				NOT ASSIGNED		
A19A1C31				NOT ASSIGNED		
A19A1C32				NOT ASSIGNED		
A19A1C33				NOT ASSIGNED		
2517A AND ABOVE A19A1C30	0160-3879	7		CAPACITOR-FXD .01UF +-20% 100VDC CER	28480	0160-3879
A19A1C31	0160-3879	7		CAPACITOR-FXD .01UF +-20% 100VDC CER	28480	0160-3879
A19A1C32	0160-3879	7		CAPACITOR-FXD .01UF +-20% 100VDC CER	28480	0160-3879
A19A1C33	0160-3879	7		CAPACITOR-FXD .01UF +-20% 100VDC CER	28480	0160-3879
A19A1CR1	1901-0518	8		DIODE-SM SIG SCHOTTKY	28480	1901-0518
A19A1CR2	1901-0518	8		DIODE-SM SIG SCHOTTKY	28480	1901-0518
A19A1CR3				NOT ASSIGNED		
A19A1CR4	1901-0050	3		DIODE-SWITCHING 80V 200MA 2NS DO-35	28480	1901-0050
A19A1CR5	1901-0050	3		DIODE-SWITCHING 80V 200MA 2NS DO-35	28480	1901-0050
A19A1CR6				DIODE-SWITCHING 80V 200MA 2NS DO-35	28480	1901-0050
A19A1CR7				NOT ASSIGNED		
A19A1CR8	1901-0050	3		DIODE-SWITCHING 80V 200MA 2NS DO-35	28480	1901-0050
A19A1CR9	1901-0050	3		DIODE-SWITCHING 80V 200MA 2NS DO-35	28480	1901-0050
A19A1CR10	1901-0050	3		DIODE-SWITCHING 80V 200MA 2NS DO-35	28480	1901-0050
A19A1CR11	1901-0050	3		DIODE-SWITCHING 80V 200MA 2NS DO-35	28480	1901-0050
A19A1FL1	9135-0214	4		FILTER-HIGH PASS PIN STYLE-TERMS	28480	9135-0214
A19A1FL2	9135-0214	4		FILTER-HIGH PASS PIN STYLE-TERMS	28480	9135-0214
A19A1FL3	9135-0214	4		FILTER-HIGH PASS PIN STYLE-TERMS	28480	9135-0214
A19A1FL4	9135-0214	4		FILTER-HIGH PASS PIN STYLE-TERMS	28480	9135-0214
A19A1FL5	9135-0214	4		FILTER-HIGH PASS PIN STYLE-TERMS	28480	9135-0214
A19A1FL6	9135-0214	4		FILTER-HIGH PASS PIN STYLE-TERMS	28480	9135-0214
A19A1FL7	9135-0214	4		FILTER-HIGH PASS PIN STYLE-TERMS	28480	9135-0214
A19A1FL8	9135-0214	4		FILTER-HIGH PASS PIN STYLE-TERMS	28480	9135-0214
A19A1FL9	9135-0214	4		FILTER-HIGH PASS PIN STYLE-TERMS	28480	9135-0214

See introduction to this section for ordering information.

\* Indicates factory selected value

Table 6-2. Replaceable Parts

Reference Designation	HP Part Number	C D	Qty	Description	Mfr Code	Mfr Part Number
A19A1J1	1251-8813	3	1	CONN-POST TYPE .100-PIN-SPCG 14-CONT	28480	1251-8813
A19A1J2	1251-8601	7		CONN-POST TYPE .100-PIN-SPCG 34-CONT	28480	1251-8601
	1251-5595	2		POLARIZING KEY-POST CONN	28480	1251-5595
A19A1J3			1	PRINTED CIRCUIT PADS		
A19A1J4	1251-8947	4			28480	1251-8947
A19A1J5			40	NOT ASSIGNED		
A19A1J6	1250-2090	4		CONNECTOR-RF SMC M SGL-HOLE-RR 50-OHM	28480	1250-2090
	08642-20081	7		ELSTRM COND SMC	28480	08642-20081
A19A1J7	1251-8759	6		CONN-POST TYPE .100-PIN-SPCG 11-CONT	28480	1251-8759
A19A1L1	9100-1621	6		INDUCTOR RF-CH-MLD 18UH 10% .166DX.385LG	28480	9100-1621
A19A1L2	9140-0105	3		INDUCTOR RF-CH-MLD 8.2UH 10%	28480	9140-0105
<i>2427A TO 2516A</i>						
<i>A19A1Q1</i>	1855-0420	2		TRANSISTOR J-FET 2N4391 N-CHAN D-MODE	01295	2N4391
<i>2517A AND ABOVE</i>				NOT ASSIGNED		
<i>A19A1Q1</i>						
A19A1Q2	1855-0420	2		TRANSISTOR J-FET 2N4391 N-CHAN D-MODE	01295	2N4391
A19A1Q3	1855-0420	2		TRANSISTOR J-FET 2N4391 N-CHAN D-MODE	01295	2N4391
A19A1Q4	1853-0459	3		TRANSISTOR PNP SI PD=625MW FT=200MHZ	28480	1853-0459
A19A1Q5	1855-0560	1		TRANSISTOR MOSFET N-CHAN E-MODE T0-52 SI	28480	1855-0560
A19A1R1	0698-7236	7		RESISTOR 1K 1% .05W F TC=0+-100	24546	C3-1/8-T0-1001-F
A19A1R2	0698-7219	6		RESISTOR 196 1% .05W F TC=0+-100	24546	C3-1/8-T0-196R-F
A19A1R3	0698-7213	0		RESISTOR 110 1% .05W F TC=0+-100	24546	C3-1/8-T0-110R-F
A19A1R4	0698-7226	5		RESISTOR 383 1% .05W F TC=0+-100	24546	C3-1/8-T0-383R-F
A19A1R5				NOT ASSIGNED		
A19A1R6				NOT ASSIGNED		
<i>2427A TO 2720A</i>						
<i>A19A1R7</i>	2100-3286	6		RESISTOR-TRMR 10K 10% C TOP-ADJ 17-TRN	32997	3292W-1-103
<i>2721A AND ABOVE</i>						
<i>A19A1R7</i>	2100-3659	7		RESISTOR-TRMR 20K 10% C TOP-ADJ 17-TRN	32997	3292W-1-203
A19A1R8	0698-7250	5		RESISTOR 3.83K 1% .05W F TC=0+-100	24546	C3-1/8-T0-3831-F
A19A1R9	0698-7257	2		RESISTOR 7.5K 1% .05W F TC=0+-100	24546	C3-1/8-T0-7501-F
A19A1R10	0698-7260	7		RESISTOR 10K 1% .05W F TC=0+-100	24546	C3-1/8-T0-1002-F
A19A1R11	2100-3097	7		RESISTOR-TRMR 100K 10% C TOP-ADJ 17-TRN	32997	3292W-1-104
A19A1R12	2100-3097	7		RESISTOR-TRMR 100K 10% C TOP-ADJ 17-TRN	32997	3292W-1-104
A19A1R13	0698-7257	2		RESISTOR 7.5K 1% .05W F TC=0+-100	24546	C3-1/8-T0-7501-F
<i>2427A TO 2720</i>						
<i>A19A1R14</i>	2100-3286	6		RESISTOR-TRMR 10K 10% C TOP-ADJ 17-TRN	32997	3292W-1-103
<i>2721A AND ABOVE</i>						
<i>A19A1R14</i>	2100-3659	7		RESISTOR-TRMR 20K 10% C TOP-ADJ 17-TRN	32997	3292W-1-203
A19A1R15	0698-7250	5		RESISTOR 3.83K 1% .05W F TC=0+-100	24546	C3-1/8-T0-3831-F
A19A1R16	0698-7260	7		RESISTOR 10K 1% .05W F TC=0+-100	24546	C3-1/8-T0-1002-F
A19A1R17-R20				NOT ASSIGNED		
A19A1R21	0698-7276	5		RESISTOR 46.4K 1% .05W F TC=0+-100	24546	C3-1/8-T0-4642-F
A19A1R22	0698-7246	9		RESISTOR 2.61K 1% .05W F TC=0+-100	24546	C3-1/8-T0-2611-F
A19A1R23-R28				NOT ASSIGNED		
A19A1R29	0698-7260	7		RESISTOR 10K 1% .05W F TC=0+-100	24546	C3-1/8-T0-1002-F
<i>2427A TO 2516A</i>						
<i>A19A1R30</i>	0698-7260	7		RESISTOR 10K 1% .05W F TC=0+-100	24546	C3-1/8-T0-1002
<i>2517A AND ABOVE</i>						
<i>A19A1R30</i>				NOT ASSIGNED		
A19A1R31	0698-7250	5		RESISTOR 3.83K 1% .05W F TC=0+-100	24546	C3-1/8-T0-3831-F
A19A1R32	0698-7240	3		RESISTOR 1.47K 1% .05W F TC=0+-100	24546	C3-1/8-T0-1471-F
A19A1R33				NOT ASSIGNED		
A19A1R34	0698-7252	7		RESISTOR 4.64K 1% .05W F TC=0+-100	24546	C3-1/8-T0-4641-F
A19A1R35				NOT ASSIGNED		
A19A1R36				NOT ASSIGNED		
A19A1R37	0698-7236	7		RESISTOR 1K 1% .05W F TC=0+-100	24546	C3-1/8-T0-1001-F
A19A1R38	0698-7260	7		RESISTOR 10K 1% .05W F TC=0+-100	24546	C3-1/8-T0-1002-F
A19A1R39	0698-7236	7		RESISTOR 1K 1% .05W F TC=0+-100	24546	C3-1/8-T0-1001-F
A19A1R40	0698-7229	8		RESISTOR 511 1% .05W F TC=0+-100	24546	C3-1/8-T0-511R-F
A19A1R41	0698-7236	7		RESISTOR 1K 1% .05W F TC=0+-100	24546	C3-1/8-T0-1001-F
A19A1R42	0698-7260	7		RESISTOR 10K 1% .05W F TC=0+-100	24546	C3-1/8-T0-1002-F
A19A1R43	0698-8625	0		RESISTOR 1K .1% .1W F TC=0+-100	28480	0698-8625
A19A1R44	0699-0303	7		RESISTOR 1.33K 1% .1W F TC=0+-5	28480	0699-0303
A19A1R45	0698-5457	0		RESISTOR 990 .1% .125W F TC=0+-50	24546	C4-1/8-T0-990R-F
A19A1R46	0698-7247	0		RESISTOR 2.87K 1% .05W F TC=0+-100	24546	C3-1/8-T0-2871-F
A19A1R47	0698-7247	0		RESISTOR 2.87K 1% .05W F TC=0+-100	24546	C3-1/8-T0-2871-F
A19A1R48	0698-7188	8		RESISTOR 10 1% .05W F TC=0+-100	24546	C3-1/8-T0-10R-F
A19A1R49	0698-7188	8		RESISTOR 10 1% .05W F TC=0+-100	24546	C3-1/8-T0-10R-F
A19A1R50	0698-7244	7		RESISTOR 2.15K 1% .05W F TC=0+-100	24546	C3-1/8-T0-2151-F
A19A1R51	0698-7236	7		RESISTOR 1K 1% .05W F TC=0+-100	24546	C3-1/8-T0-1001-F
A19A1R52	0698-8827	4		RESISTOR 1M 1% .125W F TC=0+-100	28480	0698-8827
A19A1R53	0698-7236	7		RESISTOR 1K 1% .05W F TC=0+-100	24546	C3-1/8-T0-1001-F

See introduction to this section for ordering information.

\* Indicates factory selected value

Table 6-2. Replaceable Parts

Reference Designation	HP Part Number	C D	Qty	Description	Mfr Code	Mfr Part Number
A19A1R54-R76				NOT ASSIGNED		
A19A1R77	0698-7212	9		RESISTOR 100 1% .05W F TC=0+-100	24546	C3-1/8-T0-100R-F
A19A1R78	0698-7212	9		RESISTOR 100 1% .05W F TC=0+-100	24546	C3-1/8-T0-100R-F
A19A1R79	0698-7253	8		RESISTOR 5.11K 1% .05W F TC=0+-100	24546	C3-1/8-T0-5111-F
A19A1R80	0698-7260	7		RESISTOR 10K 1% .05W F TC=0+-100	24546	C3-1/8-T0-1002-F
A19A1R81	0698-7253	8		RESISTOR 5.11K 1% .05W F TC=0+-100	24546	C3-1/8-T0-5111-F
A19A1R82	0698-7260	7		RESISTOR 10K 1% .05W F TC=0+-100	24546	C3-1/8-T0-1002-F
A19A1R83	0698-8958	2		RESISTOR 511K 1% .125W F TC=0+-100	28480	0698-8958
A19A1TP1	0360-0535	0		TERMINAL TEST POINT PCB	00000	ORDER BY DESCRIPTION
A19A1TP2	0360-0535	0		TERMINAL TEST POINT PCB	00000	ORDER BY DESCRIPTION
A19A1U1	1820-1416	5		IC SCHMITT-TRIG TTL LS INV HEX 1-INP	01295	SN74LS14N
A19A1U2	1820-1433	6		IC SHF-RGTR TTL LS R-S SERIAL-IN PRL-OUT	01295	SN74LS164N
A19A1U3	1820-1858	9		IC FF TTL LS D-TYPE OCTL	01295	SN74LS377N
A19A1U4	1820-1433	6		IC SHF-RGTR TTL LS R-S SERIAL-IN PRL-OUT	01295	SN74LS164N
A19A1U5	1820-1858	9		IC FF TTL LS D-TYPE OCTL	01295	SN74LS377N
A19A1U6	1820-1433	6		IC SHF-RGTR TTL LS R-S SERIAL-IN PRL-OUT	01295	SN74LS164N
A19A1U7	1820-1858	9		IC FF TTL LS D-TYPE OCTL	01295	SN74LS377N
A19A1U8	1820-1212	9		IC FF TTL LS J-K NEG-EDGE-TRIG	01295	SN74LS112AN
A19A1U9	1826-0921	7		D/A 10-BIT 16-CBRZ/SDR CMOS	28480	1826-0921
A19A1U10	1826-0605	4		IC MULTIPLXR 8-CHAN-ANLG 16-DIP-C PKG	17856	DG508BK
2427A TO 2516A A19A1U11	1826-0896	5		D/A 12-BIT 24-CBRZ/SDR BPLR	28480	1826-0896
2517A AND ABOVE A19A1U11	1826-1013	0		D/1 12-1/2-BIT 24-DIP-C BPLR	28480	1826-1013
A19A1U12	1826-0783	9		IC OP AMP LOW-NOISE 8-DIP-C PKG	52063	XR5534ACN
A19A1U13	1826-0412	1		IC COMPARATOR PRCN DUAL 8-DIP-P PKG	27014	LM393N
A19A1U14	1826-0783	9		IC OP AMP LOW-NOISE 8-DIP-C PKG	52063	XR5534ACN
A19A1U15	1826-0716	8		IC OP AMP LOW-NOISE DUAL 8-DIP-C PKG	18324	NE5532AFE
A19A1U16	1826-0412	1		IC COMPARATOR PRCN DUAL 8-DIP-P PKG	27014	LM393N
A19A1U17	1826-0716	8		IC OP AMP LOW-NOISE DUAL 8-DIP-C PKG	18324	NE5532AFE
2427A TO 2516A A19A1U18	1826-0412	1		IC COMPARATOR PRCN DUAL 8-DIP-P PKG	27014	LM393N
2517A AND ABOVE A19A1U18				NOT ASSIGNED		
A19A1VR1	1902-0961	7	1	DIODE-ZNR 13V 5% DO-35 PD=.4W TC=+.082%	28480	1902-0961
A19A1VR2	1902-0958	2	2	DIODE-ZNR 10V 5% DO-35 PD=.4W TC=+.075%	28480	1902-0958
A19A1VR3	1902-0965	1	1	DIODE-ZNR 20V 5% DO-35 PD=.4W TC=+.092%	28480	1902-0965
2427A TO 2516A A19A1W1	8159-0005	0		RESISTOR-ZERO OHMS 22 AWG LEAD DIA	28480	8159-0005
2517A AND ABOVE A19A1W1				NOT ASSIGNED		
A19A1W2	8159-0005	0		RESISTOR-ZERO OHMS 22 AWG LEAD DIA	28480	8159-0005
A19A1W3	08642-60073	1	1	CABLE ASSEMBLY (A19A1J3 TO A19A2J3)	28480	08642-60073

See introduction to this section for ordering information.

\* Indicates factory selected value





Table 6-2. Replaceable Parts

Reference Designation	HP Part Number	C D	Qty	Description	Mfr Code	Mfr Part Number
<b>A19A2</b>	08642-60119	6	1	REVERSE POWER PROTECT ASSEMBLY	28480	08642-60119
<i>2637A TO 2640A A19A2C1</i>	0160-6356	1	2	CAPACITOR-FXD .22U +-20% 100 VDC CER	28480	0160-6356M
<i>2640A AND ABOVE A19A2C1 A19A2C4</i>	0160-0546	9	2	CAPACITOR-FXD .1UF +-20% 100VDC CER	28480	0160-0546
	0160-0546	9	2	CAPACITOR-FXD .1UF +-20% 100VDC CER	28480	0160-0546
A19A2CR1	1901-0539	3		DIODE-SM SIG SCHOTTKY	28480	1901-0539
A19A2FL1	9135-0214	4		FILTER-HIGH PASS PIN STYLE-TERMS	28480	9135-0214
A19A2FL2	9135-0214	4		FILTER-HIGH PASS PIN STYLE-TERMS	28480	9135-0214
A19A2J1	08642-80018	6		CONNECTOR-RF	28480	08642-80018
A19A2J2	08642-20079	3	3	ELSTMR CNDCT SMA	28480	08642-20079
	08642-80018	6		CONNECTOR-RF	28480	08642-80018
A19A2J3	08642-20079	3	3	ELSTMR CNDCT SMA	28480	08642-20079
	1251-8948	5		CONN POST TYPE 2.5-PIN-SPCG 2-CONT	28480	1251-8948
<i>2427A TO 2449A A19A2K1</i>	0490-1185	3	1	RELAY-REED 1A 500MA 100VDC 5VDC-COIL	28480	0490-1185
<i>2507A AND ABOVE A19A2K1</i>	0490-1452	7	1	RELAY-REED 1A 500MA 100VDC 5VDC-COIL	28480	0490-1452
A19A2U1	08642-67004	2	1	X2 REV PWR LIMTR	28480	08642-67004
A19A2Z1	1600-0265	4	1	NICKEL DISC .15IN .01IN ASTM F-15	28480	1600-0265

See introduction to this section for ordering information.

\* Indicates factory selected value



Table 6-2. Replaceable Parts

Reference Designation	HP Part Number	C D	Qty	Description	Mfr Code	Mfr Part Number
2427A TO 2637A A19A3	08642-60220	0	1	DOUBLER/ALC ASSEMBLY	28480	08642-60220
2640A TO 2735A A19A3	08642-60320	1	1	DOUBLER/ALC ASSEMBLY	28480	08642-60320
2744A AND ABOVE A19A3	08642-60420	2	1	DOUBLER/ALC ASSEMBLY	28480	08642-60420
A19A3C1	0180-0553	0		CAPACITOR-FXD 22UF+-20% 25VDC TA	28480	0180-0553
A19A3C2	0160-0576	5		CAPACITOR-FXD .1UF +-20% 50VDC CER	28480	0160-0576
A19A3C3	0160-0576	5		CAPACITOR-FXD .1UF +-20% 50VDC CER	28480	0160-0576
A19A3C4	0160-0576	5		CAPACITOR-FXD .1UF +-20% 50VDC CER	28480	0160-0576
A19A3C5	0160-0576	5		CAPACITOR-FXD .1UF +-20% 50VDC CER	28480	0160-0576
A19A3C6	0160-4787	8		CAPACITOR-FXD 22PF +-5% 100VDC CER 0+-30	28480	0160-4787
A19A3C7	0160-4835	7		CAPACITOR-FXD .1UF +-10% 50VDC CER	28480	0160-4835
A19A3C8	0160-0576	5		CAPACITOR-FXD .1UF +-20% 50VDC CER	28480	0160-0576
A19A3CR1	1906-0244	7	1	DIODE-FW BROG 2V	17540	D5848
	08642-00119	0	1	PEDESTAL-SEMIRIG	28480	08642-00119
A19A3CR2	1901-0539	3		DIODE-SM SIG SCHOTTKY	28480	1901-0539
A19A3CR3	1901-0539	3		DIODE-SM SIG SCHOTTKY	28480	1901-0539
A19A3CR4	1901-0539	3		DIODE-SM SIG SCHOTTKY	28480	1901-0539
A19A3E1	9170-0029	3		CORE-SHIELDING BEAD	28480	9170-0029
A19A3E2	9170-0029	3		CORE-SHIELDING BEAD	28480	9170-0029
A19A3E3	9170-0029	3		CORE-SHIELDING BEAD	28480	9170-0029
A19A3E4	9170-0029	3		CORE-SHIELDING BEAD	28480	9170-0029
A19A3E5	9170-0029	3		CORE-SHIELDING BEAD	28480	9170-0029
A19A3E6	9170-0029	3		CORE-SHIELDING BEAD	28480	9170-0029
A19A3E7	9170-0029	3		CORE-SHIELDING BEAD	28480	9170-0029
A19A3E8	9170-0029	3		CORE-SHIELDING BEAD	28480	9170-0029
A19A3J1	1250-2090	4		CONNECTOR-RF SMC M SGL-HOLE-RR 50-OHM	28480	1250-2090
A19A3J2	08642-20081	7		ELSTMR COND SMC	28480	08642-20081
A19A3J3	1251-8759	6		NOT ASSIGNED CONN-POST TYPE .100-PIN-SPCG 11-CONT	28480	1251-8759
2427A TO 2637A A19A3L1	9140-1087	2	1	INDUCTOR-FIXED 120-1300 HZ	28480	9140-1087
A19A3L2	9140-0261	2		INDUCTOR RF-CH-MLD 100NH 5% .166DX.385LG	28480	9140-0261
2640A TO 2751A A19A3L1	9135-0078	8	1	INDUCTOR RF-CH-MLD 82NH 7% .102DX.26LG	28480	9135-0078
2640A TO 2751A A19A3L2	9100-2250	9	1	INDUCTOR RF-CH-MLD 180NH 10% .105DX.26LG	28480	9100-2250
2835A AND ABOVE A19A3L1	9100-2817	4		INDUCTOR RF-CH-MLD 100NH 5% .105DX.26LG	28480	9100-2817
A19A3MP1	5021-3273	6		CABLE HOLDER	28480	5021-3273
A19A3Q1	1854-0814	6	1	TRANSISTOR NPN SI TO-66 PD=75W FT=3MHZ	28480	1854-0814
	0515-1084	5		SCREW-MACH M3 X 0.5 12MM-LG PAN-HD	28480	0515-1084
	0535-0004	9		NUT-HEX DBL-CHAM M3 X 0.5 2.4MM-THK	00000	ORDER BY DESCRIPTION
	0340-0933	0	2	INSULATOR-FLG-BSHG PPS BLACK	28480	0340-0933
	2190-0584	0		WASHER-LK HLCL 3.0 MM 3.1-MM-ID	28480	2190-0584
	08642-00082	6	1	HEATSINK TO-66	28480	08642-00082
2427A TO 2721A A19A3R1	2100-3089	7	3	RESISTOR-TRMR 5K 10% C TOP-ADJ 17-TRN	32997	3292W-1-502
2735A AND ABOVE A19A3R1	2100-3286	6		RESISTOR-TRMR 10K 10% C TOP-ADJ 17-TRN	32997	3292W-1-103
A19A3R2				NOT ASSIGNED		
A19A3R3	2100-3089	7		RESISTOR-TRMR 5K 10% C TOP-ADJ 17-TRN	32997	3292W-1-502
A19A3R4	2100-3089	7		RESISTOR-TRMR 5K 10% C TOP-ADJ 17-TRN	32997	3292W-1-502
A19A3R5	2100-3296	8		RESISTOR-TRMR 1K 10% C TOP-ADJ 17-TRN	28480	2100-3296
A19A3R6	0698-7236	7		RESISTOR 1K 1% .05W F TC=0+-100	24546	C3-1/8-T0-1001-F
A19A3R7				NOT ASSIGNED		
A19A3R8				NOT ASSIGNED		
A19A3R9	0698-7260	7		RESISTOR 10K 1% .05W F TC=0+-100	24546	C3-1/8-T0-1002-F
A19A3R10	0698-3603	4	2	RESISTOR 12 5% 2W MO TC=0+-200	27167	FP42-2-T00-12R0-J
A19A3R11				NOT ASSIGNED		
A19A3R12				NOT ASSIGNED		
A19A3R13	0698-7253	8		RESISTOR 5.11K 1% .05W F TC=0+-100	24546	C3-1/8-T0-5111-F
A19A3R14	0698-7231	2		RESISTOR 619 1% .05W F TC=0+-100	24546	C3-1/8-T0-619R-F
A19A3R15	0698-7236	7		RESISTOR 1K 1% .05W F TC=0+-100	24546	C3-1/8-T0-1001-F
A19A3R16	0698-7271	0		RESISTOR 28.7K 1% .05W F TC=0+-100	24546	C3-1/8-T0-2872-F
A19A3R17	0698-7271	0		RESISTOR 28.7K 1% .05W F TC=0+-100	24546	C3-1/8-T0-2872-F
A19A3R18	0698-8812	7	3	RESISTOR 1 1% .125W F TC=0+-100	28480	0698-8812
A19A3R19	0698-8812	7		RESISTOR 1 1% .125W F TC=0+-100	28480	0698-8812
A19A3R20	0698-7271	0		RESISTOR 28.7K 1% .05W F TC=0+-100	24546	C3-1/8-T0-2872-F

See introduction to this section for ordering information.

\* Indicates factory selected value

Table 6-2. Replaceable Parts

Reference Designation	HP Part Number	C D	Qty	Description	Mfr Code	Mfr Part Number
A19A3R21	0698-3458	7		RESISTOR 348K 1% .125W F TC=0+-100	28480	0698-3458
A19A3R22	0698-3458	7		RESISTOR 348K 1% .125W F TC=0+-100	28480	0698-3458
A19A3R23	0698-8625	0		RESISTOR 1K .1% .1W F TC=0+-100	28480	0698-8625
A19A3R24				NOT ASSIGNED		
A19A3R25				NOT ASSIGNED		
A19A3R26	0698-8625	0		RESISTOR 1K .1% .1W F TC=0+-100	28480	0698-8625
A19A3R27	0698-8625	0		RESISTOR 1K .1% .1W F TC=0+-100	28480	0698-8625
A19A3R28	0698-7255	0		RESISTOR 6.19K 1% .05W F TC=0+-100	24546	C3-1/8-T0-6191-F
A19A3R29				NOT ASSIGNED		
A19A3R30	0698-8812	7		RESISTOR 1 1% .125W F TC=0+-100	28480	0698-8812
A19A3R31	0698-7222	1		RESISTOR 261 1% .05W F TC=0+-100	24546	C3-1/8-T0-261R-F
A19A3R32	0698-3603	4		RESISTOR 12 5% 2W MO TC=0+-200	27167	FP42-2-T00-12R0-J
A19A3R33	0698-7268	5		RESISTOR 21.5K 1% .05W F TC=0+-100	24546	C3-1/8-T0-2152-F
A19A3R34	0698-3258	5	1	RESISTOR 5.36K 1% .125W F TC=0+-100	24546	C4-1/8-T0-5361-F
A19A3R35	0698-7255	0		RESISTOR 6.19K 1% .05W F TC=0+-100	24546	C3-1/8-T0-6191-F
A19A3R36	0698-8625	0		RESISTOR 1K .1% .1W F TC=0+-100	28480	0698-8625
A19A3R37	0698-7260	7		RESISTOR 10K 1% .05W F TC=0+-100	24546	C3-1/8-T0-1002-F
A19A3R38				NOT ASSIGNED		
A19A3R39	0698-7260	7		RESISTOR 10K 1% .05W F TC=0+-100	24546	C3-1/8-T0-1002-F
A19A3R40	0698-7260	7		RESISTOR 10K 1% .05W F TC=0+-100	24546	C3-1/8-T0-1002-F
A19A3R41	0698-7260	7		RESISTOR 10K 1% .05W F TC=0+-100	24546	C3-1/8-T0-1002-F
A19A3R42	0698-7275	4		RESISTOR 42.2K 1% .05W F TC=0+-100	24546	C3-1/8-T0-4222-F
A19A3R43	0698-7247	0		RESISTOR 2.87K 1% .05W F TC=0+-100	24546	C3-1/8-T0-2871-F
A19A3R44				NOT ASSIGNED		
A19A3R45	0698-7260	7		RESISTOR 10K 1% .05W F TC=0+-100	24546	C3-1/8-T0-1002-F
A19A3R46	0698-7188	8		RESISTOR 10 1% .05W F TC=0+-100	24546	C3-1/8-T0-10R-F
A19A3TP1	0360-0535	0		TERMINAL TEST POINT PCB	00000	ORDER BY DESCRIPTION
A19A3TP2				NOT ASSIGNED		
A19A3TP3	0360-0535	0		TERMINAL TEST POINT PCB	00000	ORDER BY DESCRIPTION
A19A3TP4	0360-0535	0		TERMINAL TEST POINT PCB	00000	ORDER BY DESCRIPTION
A19A3TP5	0360-0535	0		TERMINAL TEST POINT PCB	00000	ORDER BY DESCRIPTION
A19A3TP6	0360-0535	0		TERMINAL TEST POINT PCB	00000	ORDER BY DESCRIPTION
A19A3TP7	0360-0535	0		TERMINAL TEST POINT PCB	00000	ORDER BY DESCRIPTION
A19A3TP8	0360-0535	0		TERMINAL TEST POINT PCB	00000	ORDER BY DESCRIPTION
A19A3TP9	0360-0535	0		TERMINAL TEST POINT PCB	00000	ORDER BY DESCRIPTION
A19A3U1	1826-0716	8		IC OP AMP LOW-NOISE DUAL 8-DIP-C PKG	18324	NE5532AFE
2427A TO 2735A						
A19A3U2	08642-67002	0	1	X2 POWER AMP	28480	08642-67002
A19A3U3	08642-67003	1	1	X2 AMP MOD FILTR	28480	08642-67003
2749A AND ABOVE						
A19A3U2	08642-67002	0	1	X2 POWER AMP	28480	08642-67002
	1251-3172	7	1	CONNECTOR-SGL CONT SKT .03-IN-BSC-SZ RND	28480	1251-3172
A19A3U3	08642-67003	1	1	X2 AMP MOD FILTR	28480	08642-67003
	1251-3172	7	1	CONNECTOR-SGL CONT SKT .03-IN-BSC-SZ RND	28480	1251-3172
A19A3U4	1826-0783	9		IC OP AMP LOW-NOISE 8-DIP-C PKG	52063	XR5534ACN
A19A3VR1	1902-0951	5	1	DIODE-ZNR 5.1V 5% DO-35 PD=.4W TC=+.035%	28480	1902-0951
A19A3VR2	1902-0958	2		DIODE-ZNR 10V 5% DO-35 PD=.4W TC=+.075%	28480	1902-0958
A19A3W1	08642-20063	5	1	CBL SR X2 MCKTS	28480	08642-20063
A19A3W2	08642-20064	6	1	CBL SR X2 FLTR	28480	08642-20064
	08642-20086	2		ELSTMR FEEDTHRU	28480	08642-20086
A19A3W3	08642-20070	4	1	CABLE SR-TL 1	28480	08642-20070
A19A3W4	08642-20071	5	1	CABLE SR-TL 2	28480	08642-20071

See introduction to this section for ordering information.

\* Indicates factory selected value

Table 6-2. Replaceable Parts

Reference Designation	HP Part Number	C D	Qty	Description	Mfr Code	Mfr Part Number
<b>A 20</b>						
A20	08642-60133	4	1	CALIBRATION DATA MODULE	28480	08642-60133
A20C1	0180-1746	5	1	CAPACITOR-FXD 15UF+-10% 20VDC TA	56289	150D156X9020B2
A20C2	0160-4835	7		CAPACITOR-FXD .1UF +-10% 50VDC CER	28480	0160-4835
A20LS1	9164-0183	7	1	AUDIO TRANSDUCER	28480	9164-0183
A20MP1	5021-3273	6		CABLE HOLDER	28480	5021-3273
A20MP2	0380-1705	0	4	STANDOFF-1/4 TURN 6.35 MM LG; 10.16 MM	28480	0380-1705
A20P1	1251-8098	6	1	CONN-POST TYPE .100-PIN-SPCG 50-CONT	28480	1251-8098
A20R1	0757-0458	7		RESISTOR 51.1K 1% .125W F TC=0+-100	24546	C4-1/8-T0-5112-F
A20S1	3101-2566	6		SWITCH-RKR DIP-RKR-ASSY DPDT .5A 30VDC	28480	3101-2566
A20U1	1818-3375	4		IC NMOS 16384 (16K) EARAM 450-NS 3-S	28480	1818-3375
A20U2	1818-3375	4		IC NMOS 16384 (16K) EARAM 450-NS 3-S	28480	1818-3375

See introduction to this section for ordering information.

\* Indicates factory selected value

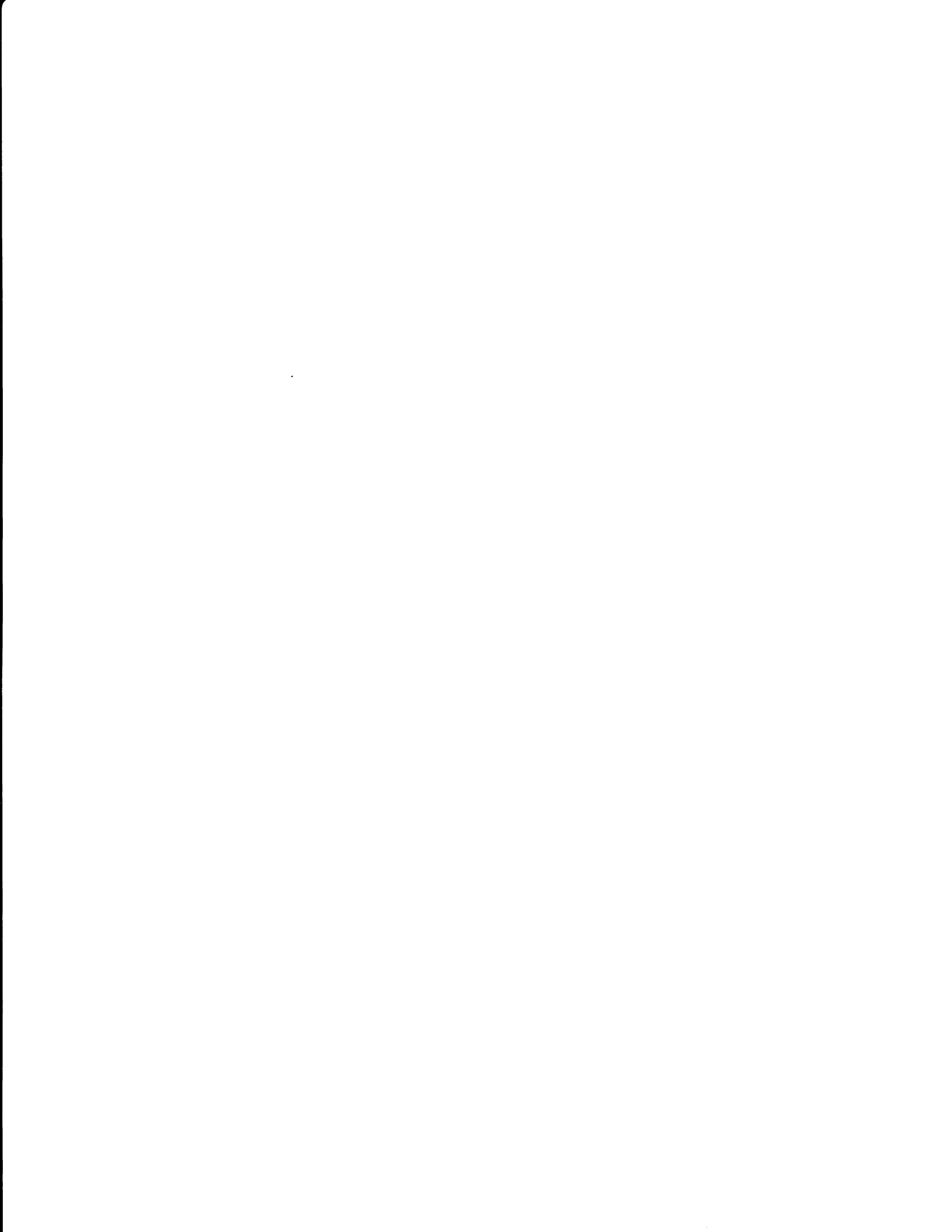

Table 6-2. Replaceable Parts

Reference Designation	HP Part Number	C D	Qty	Description	Mfr Code	Mfr Part Number
<b>A21</b>						
A21	5061-4824	9	1	ROTARY PULSE GENERATOR ASSEMBLY	28480	5061-4824
	0960-0684	2	1	ROTARY PULSE GENERATOR INPUT POWER: 5VDC	28480	0960-0684
	1251-3963	4	1	KEY-POST CONN	28480	1251-3967
	1251-3967	8	4	CONTACT-CONN U/W-POST TYPE FEM CRP	28480	1251-3967
	1251-4511	0	1	CONNECTOR 6-PIN F POST TYPE	27480	11251 4511
A21MP1	0370-2389	7		KNOB-BASE 1-1/2 JGK .25-IN-ID	28480	0370-2110
	3050-0067	9	1	WASHER-FL MTLC 5/16 IN .375-IN-ID	28480	3050-0067
	0370-2110	2	2	KNOB-BASE 1-1/8 JGK .25-IN-ID	28480	0370-2110
A21MP2	3050-0016	8	1	WASHER-FL MTLC NO. 6 .147-IN-ID	28480	3050-0016
A21MP3	2950-0001	8		NUT-HEX-DBL-CHAM 3/8-32-THD .094-IN-THK	00000	ORDER BY DESCRIPTION

See introduction to this section for ordering information.

\* Indicates factory selected value

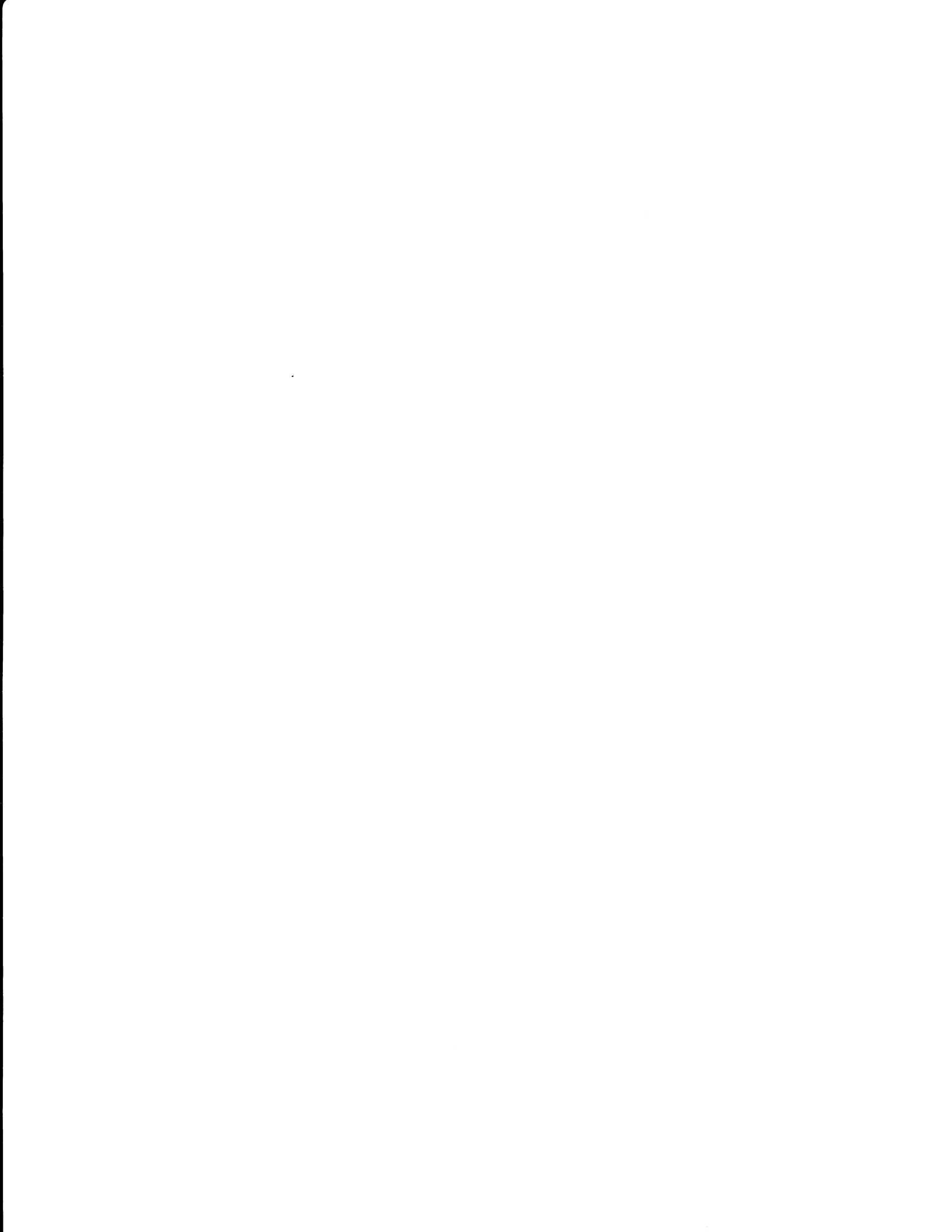



Table 6-2. Replaceable Parts

Reference Designation	HP Part Number	C D	Qty	Description	Mfr Code	Mfr Part Number
<b>MISCELLANEOUS PARTS</b>						
B1	08642-80019	7	1	FAN ASSEMBLY	28480	08642-80019
	3160-0377	7	1	FAN-TBAX 122-CFM 9.5-14VDC 16.5KV-DIEL	28480	3160-0377
	1251-7363	6	11	CONTACT-CONN U/W-POST-TYPE FEM CRP	28480	1251-7363
	1252-0070	0	1	CONN-POST TYPE .156-PIN-SPCG	28480	1252-0070
	0515-1142	6	49	SCREW-MACH M4 X 0.7 8MM-LG PAN-HD	28480	0515-1142
CP1	1250-1772	7	2	ADAPTER-COAX STR F-N F-SMA (STANDARD AND OPTION 001 ONLY; INCLUDES ATTACHING HARDWARE) FRONT PANEL "RF"	28480	1250-1772
CP2	1250-1772	7		ADAPTER-COAX STR F-N F-SMA (OPTION 002 ONLY; INCLUDES ATTACHING HARDWARE) REAR PANEL "RF OUTPUT"	28480	1250-1772
F1	2110-0003	0	1	FUSE 3A 250V NTD 1.25X.25 UL (FOR 110/120V OPERATION)	75915	312003
F1	2110-0002	9	1	FUSE 2.0A 250V NTD 1.25X.25 UL (FOR 220/240V OPERATION)	28480	2110-0002
J1	1250-1091	3	6	CONNECTOR-RF BNC FEM SGL-HOLE-RR 50-OHM "AM PULSE" PART OF W18	28480	1250-1091
	3050-1016	0	6	WASHER-FL MTLT 1/2 IN .503-IN-ID	28480	3050-1016
	08642-00139	4	6	WASHER, CAPACITIVE	28480	08642-00139
	08642-40072	8	6	BNC INSULATOR	28480	08642-40072
	0590-1251	6	3	NUT-SPCLY 15/32-32-THD .1-IN-THK .562-WD	00000	ORDER BY DESCRIPTION
J2	1250-1091	3		CONNECTOR-RF BNC FEM SGL-HOLE-RR 50-OHM "FM/OM PART OF W19	28480	1250-1091
	3050-1016	0		WASHER-FL MTLT 1/2 IN .503-IN-ID	28480	3050-1016
	08642-00139	4		WASHER, CAPACITIVE	28480	08642-00139
	0590-1251	6	3	NUT-SPCLY 15/32-32-THD .1-IN-THK .562-WD	00000	ORDER BY DESCRIPTION
	08642-40072	8		BNC INSULATOR	28480	08642-40072
J3	1250-1091	3		CONNECTOR-RF BNC FEM SGL-HOLE-RR 50-OHM "MOD" PART OF W17	28480	1250-1091
	3050-1016	0		WASHER-FL MTLT 1/2 IN .503-IN-ID	28480	3050-1016
	08642-00139	4		WASHER, CAPACITIVE	28480	08642-00139
	08642-40072	8		BNC INSULATOR	28480	08642-40072
	0590-1251	6	3	NUT-SPCLY 15/32-32-THD .1-IN-THK .562-WD	00000	ORDER BY DESCRIPTION
J4	1250-0870	4	3	CONNECTOR-RF BNC FEM SGL-HOLE-RR 50-OHM "EXT REF INPUT" PART OF W23	28480	1250-0870
	2190-0102	8	6	WASHER-LK INTL T 15/32 IN .472-IN-ID	28480	2190-0102
	2950-0035	8	6	NUT-HEX-DBL-CHAM 15/32-32-THD	00000	ORDER BY DESCRIPTION
J5	1250-0870	4		CONNECTOR-RF BNC FEM SGL-HOLE-RR 50-OHM "10MHZ OVEN"	28480	1250-0870
	2190-0102	8		PART OF W101 (OPTION 001 ONLY)	28480	2190-0102
	2950-0035	8		WASHER-LK INTL T 15/32 IN .472-IN-ID NUT-HEX-DBL-CHAM 15/32-32-THD	00000	ORDER BY DESCRIPTION
J6	1250-1091	3		CONNECTOR-RF BNC FEM SGL-HOLE-RR 50-OHM "AM PULSE"	28480	1250-1091
	3050-1016	0		PART OF W202 (OPTION 002 ONLY)	28480	3050-1016
	08642-00139	4		WASHER-FL MTLT 1/2 IN .503-IN-ID	28480	08642-00139
	08642-40072	8		WASHER, CAPACITIVE	28480	08642-40072
	2950-0035	8		BNC INSULATOR NUT-HEX-DBL-CHAM 15/32-32-THD	00000	ORDER BY DESCRIPTION
J7	1250-0083	1	2	CONNECTOR-RF BNC FEM SGL-HOLE-FR 50-OHM "X-AXIS"	28480	1250-0083
	2190-0016	3	4	WASHER-LK INTL T 3/8 IN .377-IN-ID	28480	2190-0016
	0360-1190	5	2	TERMINAL-SLDR LUG PL-MTG FOR- 3/8-SCR	28480	0360-1190
	2950-0001	8	3	NUT-HEX-DBL-CHAM 3/8-32-THD .094-IN-THK	00000	ORDER BY DESCRIPTION
	0362-0227	1	4	CONNECTOR-SGL CONT SKT 1.14-MM-BSC-SZ	28480	0362-0227
J8	1250-0870	4		CONNECTOR-RF BNC FEM SGL-HOLE-RR 50-OHM "10MHZ OUT" PART OF W23	28480	1250-0870
	2190-0102	8		WASHER-LK INTL T 15/32 IN .472-IN-ID	28480	2190-0102
	2950-0035	8		NUT-HEX-DBL-CHAM 15/32-32-THD	00000	ORDER BY DESCRIPTION
J9	1250-1091	3		CONNECTOR-RF BNC FEM SGL-HOLE-RR 50-OHM "FM/OM"	28480	1250-1091
	3050-1016	0		PART OF W201 (OPTION 002 ONLY)	28480	3050-1016
	08642-00139	4		WASHER-FL MTLT 1/2 IN .503-IN-ID	28480	08642-00139
	08642-40072	8		WASHER, CAPACITIVE	28480	08642-40072
	2950-0035	8		BNC INSULATOR NUT-HEX-DBL-CHAM 15/32-32-THD	00000	ORDER BY DESCRIPTION

See introduction to this section for ordering information.

\* Indicates factory selected value

Table 6-2. Replaceable Parts

Reference Designation	Part Number	U D	Qty	Description	Code	Mfr Part Number
J10	1250-0083	1		CONNECTOR-RF BNC FEM SGL-HOLE-FR 50-OHM "Z-AXIS"	28480	1250-0083
	2190-0016	3		WASHER-LK INTL T 3/8 IN .377-IN-ID	28480	2190-0016
	0360-1190	5		TERMINAL-SLDR LUG PL-MTG FOR- 3/8-SCR	28480	0360-1190
	2950-0001	8		NUT-HEX-DBL-CHAM 3/8-32-THD .094-IN-THK	00000	ORDER BY DESCRIPTION
	0362-0227	1		CONNECTOR-SGL CONT SKT 1.14-MM-BSC-SZ	28480	0362-0227
J11	1250-1091	3		CONNECTOR-RF BNC FEM SGL-HOLE-RR 50-OHM "MOD OUT"	28480	1250-1091
	3050-1016	0		PART OF W203 (OPTION 002 ONLY)		
	08642-00139	4		WASHER-FL MTLG 1/2 IN .503-IN-ID	28480	3050-1016
	08642-40072	8		WASHER, CAPACITIVE	28480	08642-00139
	2950-0035	8		BNC INSULATOR	28480	08642-40072
MP1	08642-00172	5	1	FRONT DRESS PANEL (STANDARD AND OPTION 001 8642A ONLY)	28480	08642-00172
	0515-0680	3		SCREW-MACH M3 X 0.5 6MM-LG PAN-HD	28480	0515-0680
	3050-0891	7		WASHER-FL MTLG 3.0 MM 3.3-MM-ID	28480	3050-0891
	0535-0004	9		NUT-HEX DBL-CHAM M3 X 0.5 2.4MM-THK	00000	ORDER BY DESCRIPTION
	0380-1362	5	40	STANDOFF-HEX 12-MM-LG M3.0 X 0.5-THD	28480	0380-1362
MP1	08642-00173	6	1	FRONT DRESS PANEL (OPTION 002 8642A ONLY)	28480	08642-00173
	0515-0680	3		SCREW-MACH M3 X 0.5 6MM-LG PAN-HD	28480	0515-0680
	3050-0891	7		WASHER-FL MTLG 3.0 MM 3.3-MM-ID	28480	3050-0891
	0535-0004	9		NUT-HEX DBL-CHAM M3 X 0.5 2.4MM-THK	00000	ORDER BY DESCRIPTION
	0380-1362	5		STANDOFF-HEX 12-MM-LG M3.0 X 0.5-THD	28480	0380-1362
MP1	08642-00174	7	1	FRONT DRESS PANEL (STANDARD AND OPTION 001 8642B ONLY)	28480	08642-00174
	0515-0680	3		SCREW-MACH M3 X 0.5 6MM-LG PAN-HD	28480	0515-0680
	3050-0891	7		WASHER-FL MTLG 3.0 MM 3.3-MM-ID	28480	3050-0891
	0535-0004	9		NUT-HEX DBL-CHAM M3 X 0.5 2.4MM-THK	00000	ORDER BY DESCRIPTION
	0380-1362	5		STANDOFF-HEX 12-MM-LG M3.0 X 0.5-THD	28480	0380-1362
MP1	08642-00175	8	1	FRONT DRESS PANEL(OPTION 002 8642B ONLY)	28480	08642-00175
	0515-0680	3		SCREW-MACH M3 X 0.5 6MM-LG PAN-HD	28480	0515-0680
	3050-0891	7		WASHER-FL MTLG 3.0 MM 3.3-MM-ID	28480	3050-0891
	0535-0004	9		NUT-HEX DBL-CHAM M3 X 0.5 2.4MM-THK	00000	ORDER BY DESCRIPTION
	0380-1362	5		STANDOFF-HEX 12-MM-LG M3.0 X 0.5-THD	28480	0380-1362
MP2	08642-00008	6	1	FRONT SUB PANEL	28480	08642-00008
	0535-0004	9		NUT-HEX DBL-CHAM M3 X 0.5 2.4MM-THK (ATTACH KEYBOARD TO SUBPANEL)	00000	ORDER BY DESCRIPTION
	0515-1227	8		SCREW-MACH M3 X 0.5 6MM-LG 90-DEG-FLH-HD (ATTACH SUB PANEL TO FRAME)	28480	0515-1227
MP3	0515-1102	8	33	SCREW-MACH M3 X 0.5 8MM-LG 90-DEG-FLH-HD (ATTACH SUB-PANEL TO FRAME)	28480	0515-1102
	08642-00009	7	1	FRONT PANEL HINGE	28480	08642-00009
	0515-1102	8		SCREW-MACH M3 X 0.5 8MM-LG 90-DEG-FLH-HD (ATTACH HINGE TO PIVOT)	28480	0515-1102
MP4	2190-0586	2	1	WASHER-LK HLCL 4.0 MM 4.1-MM-ID	28480	2190-0586
	08642-20040	8	3	HINGE PIVOT	28480	08642-20040
2427A TO 2534A MPS	0515-1102	8		SCREW-MACH M3 X 0.5 8MM-LG 90-DEG-FLH-HD (ATTACH PIVOT TO FRAME)	28480	0515-1102
	5020-8803	6	1	FRONT FRAME	28480	5020-8803
MP6	2510-0192	6	16	SCREW-MACH 8-32 .25-IN-LG 100 DEG (ATTACH FRAME TO CORNER STRUT)	00000	ORDER BY DESCRIPTION
	08642-60083	3	1	REAR FRAME WITH REAR DRESS PANEL	28480	08642-60083
MP7	0515-1142	6		SCREW-MACH M4 X 0.7 8MM-LG PAN-HD (ATTACH REAR FRAME TO REAR BRACKETS)	28480	0515-1142
	5020-8838	7	3	CORNER STRUT	28480	5020-8838
MP8	2510-0192	6		SCREW-MACH 8-32 .25-IN-LG 100 DEG (ATTACH CORNER STRUT TO FRONT AND REAR FRAMES)	00000	ORDER BY DESCRIPTION
	0515-0684	9	18	SCREW-MACH M4 X 0.7 6MM-LG PAN-HD (ATTACH CONTROLLER ASSEMBLY TO CORNER STRUTS)	28480	0515-0684
	0515-1142	6		SCREW-MACH M4 X 0.7 8MM-LG PAN-HD (ATTACH A17 TO CORNER STRUT)	28480	0515-1142
	08642-60094	6	1	SIDE STRUT SPACER ASSEMBLY	28480	08642-60094

See introduction to this section for ordering information.

\* Indicates factory selected value

Table 6-2. Replaceable Parts

Reference Designation	HP Part Number	C D	Qty	Description	Mfr Code	Mfr Part Number
2535A AND ABOVE MP5	5021-5803	2	1	FRONT FRAME SCREW-METRIC SPECIALTY M4 X 0.7 THD;6 (ATTACH FRAME TO CORNER STRUT)	28480	5021-5803
	0515-1331	5	20		28480	0515-1331
MP6	08642-60956	9	1	REAR FRAME WITH REAR DRESS PANEL SCREW-MACH M4 X 0.7 8MM-LG PAN-HD (ATTACH REAR FRAME TO REAR BRACKETS CORNER STRUT)	28480	08642-60956
	0515-1142	6			28480	0515-1142
MP7	5021-5838	3	3	SCREW-METRIC SPECIALTY M4 X 0.7 THD;6 (ATTACH CORNER STRUT TO FRONT AND REAR FRAMES)	28480	5021-5838
	0515-1331	5			28480	0515-1331
	0515-0684	9	18		28480	0515-0684
	0515-1142	6			28480	0515-1142
MP8	08642-60957	9	1	SIDE STRUT SPACER ASSEMBLY	28480	08642-60957
MP9	5001-0439	8	2	SIDE TRIM (FRONT)	28480	5001-0439
MP10	5040-7202	9	1	TOP TRIM (FRONT)	28480	5040-7202
MP11	5060-9881	6	1	SIDE COVER (LEFT, WITH HANDLE RECESS)	28480	5060-9881
2427A TO 2534A MP12	5060-9913	5	1	SIDE COVER (RIGHT, PERFORATED)	28480	5060-9913
2535A AND ABOVE MP12	08642-00152	1	1	SIDE COVER (RIGHT, PERFORATED)	28480	08642-00152
MP13	5060-9805	4	1	STRAP HANDLE	28480	5060-9805
2427A TO 2534A MP14	5040-7219	8	1	STRAP HANDLE CAP (FRONT)	28480	5040-7219
MP15	2680-0118	5	2	SCREW-MACH 10-32 .5-IN-LG 82 DEG	00000	ORDER BY DESCRIPTION
	5040-7220	1	1	STRAP HANDLE CAP (REAR)	28480	5040-7220
MP16	2680-0118	5		SCREW-MACH 10-32 .5-IN-LG 82 DEG	00000	ORDER BY DESCRIPTION
	08642-00118	9	1	TOP COVER	28480	08642-00118
2535A AND ABOVE MP14	5041-6819	4	1	STRAP HANDLE CAP (FRONT)	28480	5041-6819
MP15	0515-1239	2	4	SCREW-MACH M5 X 0.8 12MM-LG	00000	ORDER BY DESCRIPTION
	5041-6820	2	1	STRAP HANDLE CAP (REAR)	28480	5041-6820
MP16	0515-1239	2	4	SCREW-MACH M5 X 0.8 12MM-LG	00000	ORDER BY DESCRIPTION
	08642-00169	2	1	TOP COVER	28480	08642-00169
2427A TO 2708A MP17	7120-8138	4	1	LABEL-WARNING 6-MMOWD 51-MM-LG VINYL	28480	7120-8138
	08642-60095	7	1	BOTTOM COVER FRONT	28480	08642-60095
2724A AND ABOVE MP17	08642-00142	9	1	INSULATOR, BOTTOM FRONT COVER	28480	08642-00142
	0515-1102	8		SCREW-MACH M3 X 0.5 8MM-LG 90-DEG-FLH-HD	28480	0515-1102
2724A AND ABOVE MP17	08642-61002	8	1	BOTTOM COVER ASSEMBLY	28480	08642-61002
	08642-00142	9		INSULATOR, BOTTOM FRONT COVER	28480	08642-00142
2427A TO 2708A MP18	0515-1102	8		SCREW-MACH M3 X 0.5 8MM-LG 90-DEG-FLH-HD	28480	0515-1102
	08642-60088	8	1	BOTTOM COVER CENTER	28480	08642-60088
2724A AND ABOVE MP18	0515-1227	8		SCREW-MACH M3 X 0.5 6MM-LG 90-DEG-FLH-HD	28480	0515-1227
	08642-61002	8	1	BOTTOM COVER ASSEMBLY	28480	08642-61002
2427A TO 2708A MP19	0515-1227	8		SCREW-MACH M3 X 0.5 6MM-LG 90-DEG-FLH-HD	28480	0515-1227
	08642-60092	4	1	BOTTOM COVER REAR	28480	08642-60092
2724A AND ABOVE MP19	0515-1102	8		SCREW-MACH M3 X 0.5 8MM-LG 90-DEG-FLH-HD	28480	0515-1102
	08642-61002	8	1	BOTTOM COVER ASSEMBLY	28480	08642-61002
2724A AND ABOVE MP19	0515-1102	8		SCREW-MACH M3 X 0.5 8MM-LG 90-DEG-FLH-HD	28480	0515-1102

See introduction to this section for ordering information.

\* Indicates factory selected value

Table 6-2. Replaceable Parts

Reference Designation	HP Part Number	C D	Qty	Description	Mfr Code	Mfr Part Number
MP20	5040-7201	8	4	FOOT	28480	5040-7201
MP21	1460-1345	5	2	TILT STAND SST	28480	1460-1345
MP22	08642-00010	0	1	RF CONNECTOR BRACKET (STANDARD AND OPTION 001 ONLY)	28480	08642-00010
	0515-1101	7	2	SCREW-MACH M4 X 0.7 8MM-LG 90-DEG-FLH-HD	28480	0515-1101
MP23	08642-00011	1	1	MODULATION BOARD SHIELD	28480	08642-00011
	0515-1103	9	50	SCREW-MACH M3 X 0.5 10MM-LG (SHIELD TO KEYBOARD)	28480	0515-1103
	1400-0082	9	2	CLAMP-CABLE .125-DIA .375-WD NYL (STANDARD AND OPTION 001 ONLY)	28480	1400-0082
	2190-0584	0		WASHER-LK HLCL 3.0 MM 3.1-MM-ID (STANDARD AND OPTION 001 ONLY)	28480	2190-0584
	3050-0891	7	2	WASHER-FL MTLCL 3.0 MM 3.3-MM-ID (STANDARD AND OPTION 001 ONLY)	28480	3050-0891
MP24	08642-00140	7	1	MODULATION SHIELD INSULATOR	28480	08642-00140
2427A TO 2709A MP25	08642-00012	2	1	CONTROLLER SHIELD	28480	08642-00012
	0515-1227	8		SCREW-MACH M3 X 0.5 6MM-LG 90-DEG-FLH-HD (ATTACH SHIELD TO CONTROLLER BRACKETS)	28480	0515-1227
	0515-0680	5	14	SCREW-MACH M3 X 0.5 6MM-LG PAN-HD (ATTACH MOD BOARD TO CONTROLLER SHIELD)	28480	0515-0680
2723A AND ABOVE MP25	08642-00186	1	1	CONTROLLER SHIELD	28480	08642-00012
	0515-1227	8		SCREW-MACH M3 X 0.5 6MM-LG 90-DEG-FLH-HD (ATTACH SHIELD TO CONTROLLER BRACKETS)	28480	0515-1227
	0515-0680	5	14	SCREW-MACH M3 X 0.5 6MM-LG PAN-HD (ATTACH MOD BOARD TO CONTROLLER SHIELD)	28480	0515-0680
MP26	08642-00078	0	1	CONTROLLER GUIDE BRACKET (LEFT)	28480	08642-00078
	0515-1227	8		SCREW-MACH M3 X 0.5 6MM-LG 90-DEG-FLH-HD (ATTACH BRACKET TO DISTRIBUTION BOARD)	28480	0515-1227
	0515-0684	9		SCREW-MACH M4 X 0.7 6MM-LG PAN-HD (ATTACH BRACKET TO CORNER STRUT)	28480	0515-0684
MP27	08642-40029	5	1	CONTROLLER GUIDE (LEFT, BLACK)	28480	08642-40029
	0515-1134	6	1	SCREW-MACH M3 X 0.5 18MM-LG (TOP: ATTACH BRACKET TO FRONT BRACE)	28480	0515-1134
	0515-0682	7	1	SCREW-MACH M3 X 0.5 18MM-LG PAN-HD (TOP: ATTACH BRACKET TO FRONT BRACE)	28480	0515-0682
	0515-1135	7	2	SCREW-MACH M3 X 0.5 25MM-LG (BOTTOM: ATTACH BRACKET TO FRONT BRACE)	28480	0515-1135
	0515-0683	8	1	SCREW-MACH M3 X 0.5 25MM-LG PAN-HD (BOTTOM: ATTACH BRACKET TO FRONT BRACE)	28480	0515-0683
MP28	08642-00079	1	1	CONTROLLER GUIDE BRACKET (RIGHT)	28480	08642-00079
	0515-1227	8		SCREW-MACH M3 X 0.5 6MM-LG 90-DEG-FLH-HD (ATTACH BRACKET TO DISTRIBUTION BOARD)	28480	0515-1227
MP29	08642-40030	8	1	CONTROLLER GUIDE (RIGHT)	28480	08642-40030
	0515-1102	8		SCREW-MACH M3 X 0.5 8MM-LG 90-DEG-FLH-HD (ATTACH GUIDE AND BRACKET TO FRONT BRACE)	28480	0515-1102
MP30	08642-00086	0	2	FLAT CABLE SHIELD	28480	08642-00086
MP31	08642-00066	6	1	FLAT CABLE RETAINING BAR	28480	08642-00066
	1400-0249	0		CABLE TIE .062-.625-DIA .091-WD NYL	06383	PLT1M-8
MP32	08642-00015	5	1	FRONT BRACE	28480	08642-00015
	0515-1102	8		SCREW-MACH M3 X 0.5 8MM-LG 90-DEG-FLH-HD (ATTACHES BRACE TO GUSSETS)	28480	0515-1102
	0515-0684	9		SCREW-MACH M4 X 0.7 6MM-LG PAN-HD (ATTACHES BRACE TO CORNER STRUTS)	28480	0515-0684
MP33	08642-00014	4	1	FRONT BRACE INSULATOR	28480	08642-00014
	0515-0680	5		SCREW-MACH M3 X 0.5 6MM-LG PAN-HD (ATTACH DISTRIBUTION BOARD TO BRACE)	28480	0515-0680
MP34	08642-40031	9	3	CONTROLLER MOTHERBOARD SUPPORT	28480	08642-40031
	0515-1227	8		SCREW-MACH M3 X 0.5 6MM-LG 90-DEG-FLH-HD (ATTACH SUPPORTS TO BOARD)	28480	0515-1227
MP35	08642-40070	6	6	CABLE RETAINER (W9, W14 AND W15)	28480	08642-40070
MP36	08642-20073	7	1	BOTTOM COVER SUPPORT	28480	08642-20073
	0515-1102	8		SCREW-MACH M3 X 0.5 8MM-LG 90-DEG-FLH-HD	28480	0515-1102
MP37	08642-40034	2	14	MODULE GUIDE POST (LONG)	28480	08642-40034
	0515-1103	9		SCREW-MACH M3 X 0.5 10MM-LG 90-DEG-FLH-HD	28480	0515-1103
MP38	08642-40046	6	2	MODULE GUIDE POST (SHORT)	28480	08642-40046
	0515-1103	9		SCREW-MACH M3 X 0.5 10MM-LG 90-DEG-FLH-HD	28480	0515-1103

See introduction to this section for ordering information.

\* Indicates factory selected value

Table 6-2. Replaceable Parts

Reference Designation	HP Part Number	C D	Qty	Description	Mfr Code	Mfr Part Number
MP39	08642-60080	0	1	SIDE STRUT BRACE	28480	08642-60080
	0515-1142	6		SCREW-MACH M4 X 0.7 8MM-LG PAN-HD	28480	0515-1142
	08642-00124	7	6	CABLE CLIP	28480	08642-00124
MP40	08642-00125	8	1	TUBULAR CABLE GUIDE	28480	08642-00125
	0515-1142	6		SCREW-MACH M4 X 0.7 8MM-LG PAN-HD	28480	0515-1142
MP41	08642-60068	4	1	SHOCK BOX	28480	08642-60068
MP42	1520-0236	9	4	SHOCK MOUNT .63-EFF-HGT	28480	1520-0236
	0515-0684	9		SCREW-MACH M4 X 0.7 6MM-LG PAN-HD	28480	0515-0684
	0515-1138	0	4	(FRONT: SHOCK MOUNT TO MAIN BRACE) (REAR: ATTACH SHOCK MOUNT TO SHOCK BOX)	28480	0515-1138
	0380-0010	8	4	SPACER-RND .625-IN-LG .18-IN-ID	28480	0380-0010
MP43	08642-00080	4	1	SHOCK LIMITER	28480	08642-00080
	0515-1140	4	4	SCREW-MACH M4 X 0.7 25MM-LG	28480	0515-1140
MP44	08642-20059	9	2	SHOCK CUSHION SPACER	28480	08642-20059
MP45	08642-00020	2	1	LONG GUSSET	28480	08642-00020
	0515-1102	8		SCREW-MACH M3 X 0.5 8MM-LG 90-DEG-FLH-HD (ATTACH GUSSET TO CENTER REAR AND LEFT REAR BRACKET)	28480	0515-1102
MP46	08642-00021	3	1	SHORT GUSSET	28480	08642-00021
	0515-1102	8		SCREW-MACH M3 X 0.5 8MM-LG 90-DEG-FLH-HD (ATTACH GUSSET TO RIGHT REAR BRACKET)	28480	0515-1102
MP47	08642-60089	9	1	REAR BRACKET (LEFT)	28480	08642-60089
	0515-1142	6		SCREW-MACH M4 X 0.7 8MM-LG PAN-HD (ATTACH BRACKET TO CORNER STRUT)	28480	0515-1142
	08642-00124	7		CABLE CLIP	28480	08642-00124
MP48	08642-00171	4	1	TRANSFORMER RETAINER	28480	08642-00171
MP49	8710-1378	2	1	TORX BIT T15	28480	8710-1378
MP50	8710-1524	0	1	TORX BIT T10	28480	8710-1524
MP51	08642-20041	9	2	EXTENDER POSTS	28480	08642-20041
MP52	7100-1115	1	1	TRANSFORMER COVER	28480	7100-1115
	0515-1082	3	4	SCREW-MACH M4 X 0.7 75MM-LG PAN-HD	28480	0515-1082
	3050-2007	1	4	INSULATED WASHER	28480	3050-2007
MP53	08642-60086	6	1	REAR BRACKET (CENTER)	28480	08642-60086
	0515-1142	6		SCREW-MACH M4 X 0.7 8MM-LG PAN-HD	28480	0515-1142
	0515-1228	9	3	SCREW-MACH M4 X 0.7 6MM-LG 90-DEG-FLH-HD (ATTACH CENTER BRACKET TO RIGHT BRACKET)	28480	0515-1228
	0515-0655	4		SCREW-MACH M3 X 0.5 8MM-LG PAN-HD (ATTACH A18 TO BRACKET)	00000	ORDER BY DESCRIPTION
MP54	08642-00070	2	1	RF CONNECTOR WRENCH	28480	08642-00070
MP55	08642-00031	5	1	REAR BRACKET (RIGHT)	28480	08642-00031
	0515-1142	6		SCREW-MACH M4 X 0.7 8MM-LG PAN-HD (ATTACH BRACKET TO SUPPORT)	28480	0515-1142
	2190-0071	0	7	WASHER-LK EXT T NO. 4 .116-1N-ID	28480	2190-0071
	0515-0655	4		SCREW-MACH M3 X 0.5 8MM-LG PAN-HD (ATTACH A18 TO BRACKET)	00000	ORDER BY DESCRIPTION
	2190-0005	0	4	WASHER-LK EXT T NO. 4 .116-IN-ID	28480	2190-0005
MP56	08642-20037	3	1	REAR BRACKET SUPPORT (RIGHT)	28480	08642-20037
	0515-0381	3	6	SCREW-MACH M4 X 0.7 10MM-LG PAN-HD (ATTACH SUPPORT TO STRUT)	00000	ORDER BY DESCRIPTION
	2190-0009	4		WASHER-LK INTL NO.8 .168-IN-ID	28480	2190-0009
	08642-00116	7		SCREW CAP	28480	08642-00116
MP57	08642-00104	3	1	POWER SUPPLY L-BRACKET	28480	08642-00104
	0515-1142	6		SCREW-MACH M4 X 0.7 8MM-LG PAN-HD (ATTACH BRACKET TO STRUT)	28480	0515-1142
	08642-00116	7		SCREW CAP	28480	08642-00116
	2190-0009	4		WASHER-LK INTL NO.8 .168-IN-ID	28480	2190-0009
	0515-0655	4		SCREW-MACH M3 X 0.5 8MM-LG PAN-HD (ATTACH A18 TO BRACKET)	00000	ORDER BY DESCRIPTION
	2190-0005	0		WASHER-LK EXT T NO. 4 .116-IN-ID	28480	2190-0005
MP58	08642-00089	3	1	AIR SEAL PLATE	28480	08642-00089
	0515-1227	8		SCREW-MACH M3 X 0.5 6MM-LG 90-DEG-FLH-HD (ATTACH PLATE TO RIGHT REAR BRACKET)	28480	0515-1227
	0400-0002	2	1	GROMMET-RND .188-IN-ID .312-IN-GRV-OD	28480	0400-0002
	0400-0009	9	1	GROMMET-RND .125-IN-ID .25-IN-GRV-OD	28480	0400-0009
MP59	08642-00028	0	1	SMA RF OUT BRACKET	28480	08642-00028
MP60	0515-1102	8		SCREW-MACH M3 X 0.5 8MM-LG 90-DEG-FLH-HD	28480	0515-1102
	0515-1142	6		SCREW-MACH M4 X 0.7 8MM-LG PAN-HD (ATTACH A17 TO STRUTS)	28480	0515-1142
MP61	0515-0655	4		SCREW-MACH M3 X 0.5 8MM-LG PAN-HD (ATTACH A18 TO INSTRUMENT)	00000	ORDER BY DESCRIPTION
	2190-0071	0	7	WASHER-LK EXT T NO.4 .116-1N-ID	28480	2190-0071

See introduction to this section for ordering information.

\* Indicates factory selected value

Table 6-2. Replaceable Parts

Reference Designation	HP Part Number	C D	Qty	Description	Mfr Code	Mfr Part Number
2427A TO 2534A MP62	08642-60087	7	1	POWER SUPPLY COVER SCREW-MACH M3 X 0.5 6MM-LG 90-DEG-FLH-HD	28480	08642-60087 0515-1227
	0515-1227	8			28480	
2435A AND ABOVE MP62	08642-60143	6	1	POWER SUPPLY COVER SCREW-MACH M3 X 0.5 6MM-LG 90-DEG-FLH-HD	28480	08642-60143 0515-1227
	0515-1227	8			28480	
MP63	08642-40073	9	1	FUSE PULLER	28480	08642-40073
	08642-60082	2			28480	
MP64	0515-0681	6	1	FAN ACCESS COVER SCREW-MACH M3 X 0.5 14MM-LG PAN-HD (ATTACH ACCESS COVER TO FAN)	28480	08642-60082 0515-0681
	0515-0381	3			00000	
2447A TO 2434A MP65	08642-00091	7	1	CALIBRATION BOARD COVER	28480	08642-00091
	1390-0365	8			28480	
2535A AND ABOVE MP65	1390-0366	9	4	FASTENER-SNAP-IN PLGR FOR USE WITH FASTENER-SNAP-IN GROM FOR USE WITH STANDOFF-1/4 TURN 6.35 MM LG; 10.16 MM	28480	1390-0365 1390-0366
	0380-1705	0			28480	
MP66	08642-00157	6	1	CALIBRATION BOARD COVER	28480	08642-00157
	1390-0365	8			28480	
MP67	1390-0366	9	4	FASTENER-SNAP-IN PLGR FOR USE WITH FASTENER-SNAP-IN GROM FOR USE WITH STANDOFF-1/4 TURN 6.35 MM LG; 10.16 MM	28480	1390-0365 1390-0366
	0380-1705	0			28480	
MP68	6960-0095	5	3	PLUG-HOLE DOME-HD FOR .562-D-HOLE NYL "FM/OM", "MOD OUT", "AM/PULSE" (REAR PANEL: EXCEPT OPTION 002)	28520	6960-0095
	6960-0027	3			28480	
MP69	6960-0041	1	1	PLUG-HOLE FL-HD FOR .625-D-HOLE NYL "RF OUTPUT" (REAR PANEL: EXCEPT OPTION 002)	28480	6960-0041
	6960-0041	1			28480	
MP70	0890-0025	6	1	SPIRAL CABLE WRAP	28480	0890-0025
	1400-0249	0			06383	
MP71	08642-20072	6	7	MODULE SLIDE RIBBON CABLE SCREW (8642A ONLY)	28480	08642-20072
	08642-00092	8			28480	
MP72	7120-4296	7	1	LABEL-WARNING .688-IN-WD 1.5-IN-LG AL "WARNING HAZARDOUS VOLTAGE ALWAYS PRESENT IN THIS AREA..."	28480	7120-4296
	7120-1254	1			28480	
MP73	7124-2312	2	1	NAMEPLATE .312-IN-WD .54-IN-LG AL (HP LOGO)	28480	7120-1254
	08642-00138	3			28480	
MP74	7124-2312	2	1	LABEL-INFORMATION .21-IN-WD 2.33-IN-LG LABEL	28480	7124-2312
	08642-00138	3			28480	
MP75	7120-8138	4	1	"EXCESSIVE WEIGHT..." LABEL "CAUTION: REMOVE 4 REAR FEET BEFORE REMOVING ANY COVER."	28480	08642-00138
	7120-8138	4			28480	
2427A TO 2534A MP78	5040-7221	2	4	REAR PANEL FOOT	28480	7120-8138
	2360-0197	2			28480	
2535A AND ABOVE MP78	5040-7221	2	4	SCREW-MACH 6-32 .375-IN-LG PAN-HD-POZI	28480	5040-7221
	0515-1232	5			28480	
2709A TO 2719A MP79				NOT ASSIGNED		
2720A AND ABOVE MP79	86701-00017	3	1	DISK FAN SHIELD (PLACED BETWEEN DBLR AND ATTENUATORS)	28480	86701-00017
2427A TO 2637A RT1				NOT ASSIGNED		
2640A AND ABOVE RT1	0837-0366	6	1	THEMISTOR-SURGE PTCTR 5 OHM AT 25 DEG C	28480	0837-0366
	9100-4417	7			28480	
T1	0362-0265	6	1	TRANSFORMER	28480	0362-0265
	1251-7363	7			28480	
W1	1400-0249	0	1	CONNECTOR-SGL CONT SKT 1.14-MM-BSC-SZ CONTACT-CONN U/W-POST-TYPE FEM CRP CABLE TIE .062-.625-DIA .091-WD NYL	06383	1251-7363 PLT1M-8
	08642-60015	1			28480	
W2	08642-60016	2	1	FM CABLE, FLAT - A6A1J1, A6A2J1 TO A5J1	28480	08642-60015
	08642-60017	3			28480	
W3	08642-60018	4	1	SAWRS CABLE FLAT - A7A1J1 TO A5J2	28480	08642-60016
	08642-60019	5			28480	
W4	08642-60018	4	1	IF CABLE FLAT - A9A2J1 TO A5J3	28480	08642-60017
	08642-60019	5			28480	
W5	08642-60018	4	1	REF CABLE FLAT - A11A1J1 TO A5J4	28480	08642-60018
	08642-60019	5			28480	
W5	08642-60019	5	1	SUM CABLE FLAT - A12A3J1 TO A5J5	28480	08642-60019
	08642-60019	5			28480	

See introduction to this section for ordering information.

\* Indicates factory selected value

Table 6-2. Replaceable Parts

Reference Designation	HP Part Number	C D	Qty	Description	Mfr Code	Mfr Part Number
W6	08642-60020	8	1	OUTUHF CABLE FLAT - A13A2J1 TO A5J6	28480	08642-60020
W7	08642-60021	9	1	OUTUHF CABLE FLAT - A14A2J2 TO A5J7	28480	08642-60021
W8	08642-60023	1	1	ATTEN CABLE ASSY FLAT - A16A1J1 TO A5J8	28480	08642-60023
W9	08642-60013	9	1	DRIVERS CABLE FLAT - A17J3 TO A5J13	28480	08642-60013
W10	08642-60012	8	1	POWER SUPPLY CABLE FLAT - A17J2 TO A5J12	28480	08642-60012
W11	08642-60023	1	1	DOUBLER CABLE FLAT - A19A1J2 TO A5J8 (8642B ONLY)	28480	08642-60023
W12	08642-60014	0	1	HP-IB CABLE FLAT A15J2 TO A5J20, A5J21	28480	08642-60014
W13	08642-60038	8	1	POWER SUPPLY JUMPER - A18J3 TO A17J1	28480	08642-60038
W14	08642-60010	6	1	MODULATION 20 CABLE FLAT - A2J1 TO A5J11	28480	08642-60010
W15	08642-60011	7	1	DISPLAY CABLE FLAT-A1A1J1 TO A5J9, A5J10	28480	08642-60011
W16	08642-20044	2	1	RF OUT CABLE SEMI-RIGID	28480	08642-20044
W17	08642-60060	6	1	A2J7 TO FRONT PANEL J3 "MOD" (95)	28480	08642-60060
W18	08642-60059	3	1	A2J2 TO FRONT PANEL J1 "AM/PULSE" (945)	28480	08642-60059
W19	08642-60058	2	1	A2J5 TO FRONT PANEL J2 "FM/0M" (98)	28480	08642-60058
W20	08642-60064	0	1	A6A1J4 TO A2J6 (967)	28480	08642-60064
W21	08642-60062	8	1	A6A2J3 TO A2J8 (93)	28480	08642-60062
W22	08642-60061	7	1	A2J3 TO A13A2J4 (90)	28480	08642-60061
W23	08642-60057	1	1	A6A2J5 TO REAR PANEL J8 "10 MHZ OUT" (903)	28480	08642-60057
W24	08642-60051	5	1	A6A1J2 TO A11A1J3 (935)	28480	08642-60051
W25	08642-60052	6	1	A7A1J3 TO A11A3J4 (937)	28480	08642-60052
W26	08642-60053	7	1	A6A2J6 TO A9A2J3 (905)	28480	08642-60053
W27	08642-60056	0	1	A6A2J7 TO REAR PANEL J4 "EXT REF INPUT" (97)	28480	08642-60056
W28	08642-60054	8	1	A6A2J8 TO A7A1J2 (927)	28480	08642-60054
W29	08642-60035	5	1	A6A2J9 TO A14A2J1 (926)	28480	08642-60035
W30	08642-60036	6	1	A9A1J4 TO A12A3J6 (956)	28480	08642-60036
W31	08642-60039	9	1	A11A3J2 TO A12A2J2 (901)	28480	08642-60039
W32	08642-60037	7	1	A12A3J3 TO A13A2J6 (957)	28480	08642-60037
W33	08642-60063	9	1	A2J4 TO A19A1J6 (96) 8642B ONLY	28480	08642-60063
<b>2427A TO 2509A</b>						
W34	08642-20048	6	1	A13A2J3 TO A14U1J2	28480	08642-
W35	08642-20051	1	1	A14U1J3 TO A16AT1J1 (8642A ONLY)	28480	08642-20095
W36	08642-20052	2	1	A14U1J3 TO A19K1J2 (8642B ONLY)	28480	08642-20052
<b>2510A AND ABOVE</b>						
W34	08642-20095	3	1	A13A2J3 TO A14U1J2	28480	08642-20094
W35	08642-20096	4	1	A14U1J3 TO A16AT1J1 (8642A ONLY)	28480	08642-20095
W36	08642-20094	2	1	A14U1J3 TO A19K1J2 (8642B ONLY)	28480	08642-2009
W37	08642-20058	8	1	A16AT2J2 TO W16P2 (8642A: EXCEPT OPTION 002)	28480	08642-20058
W38	08642-20054	4	1	A16AT2J2 TO W200P2 (8642A: OPTION 002) A19A2J2 TO W16P2 (8642B: EXCEPT OPTION 002) A19A2J2 TO W200P2 (8642B: OPTION 002 ONLY)	28480	08642-20054
W39-W99				NOT ASSIGNED		
W100	1250-1499	5	1	ADAPTER COAXIAL "10 MHZ OVEN OUT" TO "EXT REF INPUT" (OPTION 001 ONLY)	28480	1250-1499
W101	08642-60055	9	1	A8J1 TO REAR PANEL J5 "10 MHZ OVEN OUT" (92) (OPTION 001 ONLY)	28480	08642-60055
W102	08642-60071	9	1	OVEN HARNESS A8 TO A18J4 (OPTION 001 ONLY)	28480	08642-60071
W103-W199				NOT ASSIGNED		
W200	08642-20045	3	1	RF OUT CABLE SEMIRIGID (REAR PANEL; OPTION 002 ONLY)	28480	08642-20045
W201	08642-60067	3	1	A2J5 TO REAR PANEL J9 "FM/0M" (98) (OPTION 002 ONLY)	28480	08642-60067
W202	08642-60066	2	1	A2J2 TO REAR PANEL J6 "AM/PULSE" (945) (OPTION 002 ONLY)	28480	08642-60066
W203	08642-60065	1	1	A2J7 TO REAR PANEL J11 "MOD OUT" (95) (OPTION 002 ONLY)	28480	08642-60065
W204-W299				NOT ASSIGNED		
<b>2427A TO 2509A</b>						
W300	08642-20093	1	1	A14U1J3 TO A16AT1J1	28480	08642-20093
<b>2510A AND ABOVE</b>						
W300	08642-20097	5	1	A14U1J3 TO A16AT1J1	28480	08642-20097
W301	08642-20054	4	1	A16A2J2 TO W200P2	28480	08642-20054

See introduction to this section for ordering information.

\* Indicates factory selected value

Table 6-2. Replaceable Parts

Reference Designation	HP Part Number	C D	Qty	Description	Mfr Code	Mfr Part Number
W100	1250-1499	5	1	ADAPTER COAXIAL "10 MHZ OVEN OUT" TO "EXT REF INPUT" (OPTION 001 ONLY)	28480	1250-1499
W101	08642-60055	9	1	A8J1 TO REAR PANEL J5 "10 MHZ OVEN OUT" (92) (OPTION 001 ONLY)	28480	08642-60055
W102	08642-60071	9	1	OVEN HARNESS A8 TO A18J4 (OPTION 001 ONLY)	28480	08642-60071
W103-W199				NOT ASSIGNED		
W200	08642-20045	3	1	RF OUT CABLE SEMIRIGID (REAR PANEL; OPTION 002 ONLY)	28480	08642-20045
W201	08642-60067	3	1	A2J5 TO REAR PANEL J9 "FM/0M" (98) (OPTION 002 ONLY)	28480	08642-60067
W202	08642-60066	2	1	A2J2 TO REAR PANEL J6 "AM/PULSE" (945) (OPTION 002 ONLY)	28480	08642-60066
W203	08642-60065	1	1	A2J7 TO REAR PANEL J11 "MOD OUT" (95) (OPTION 002 ONLY)	28480	08642-60065
W204-W299				NOT ASSIGNED		
2427A TO 2509A W300	08642-20093	1	1	A14U1J3 TO A16AT1J1	28480	08642-20093
2510A AND ABOVE W300	08642-20097	5	1	A14U1J3 TO A16AT1J1	28480	08642-20097
W301	08642-20054	4		A16A2J2 TO W200P2	28480	08642-20054

See introduction to this section for ordering information.

\* Indicates factory selected value



Table 6-3. Manufacturers Code List

Mfr Code	Manufacturer Name	Address	Zip Code
00000	ANY SATISFACTORY SUPPLIER		
00853	SANGAMO ELEC CO S CAROLINA DIV	PICKENS SC	29671
00904	DENVER PLASTIC INC	LAKWOOD CO	80214
01121	ALLEN-BRADLEY CO	MILWAUKEE WI	53204
01295	TEXAS INSTR INC SEMICOND CMPNT DIV	DALLAS TX	75222
02111	SPECTROL ELECTRONICS CORP	CITY OF IND CA	91745
02114	FERROXCUBE CORP	SAUGERTIES NY	12477
03888	K D I PYROFILM CORP	WHIPPANY NJ	07981
04713	MOTOROLA SEMICONDUCTOR PRODUCTS	PHOENIX AZ	85008
05245	CORCOM INC	CHICAGO IL	60657
06383	PANDUIT CORP	TINLEY PARK IL	60477
07263	FAIRCHILD SEMICONDUCTOR DIV	MOUNTAIN VIEW CA	94042
07716	TRW INC BURLINGTON DIV	BURLINGTON IA	52601
11502	TRW INC BOONE DIV	BOONE NC	28607
13103	THERMALLY CO	DALLAS TX	75234
13606	SPRAGUE ELECT CO SEMICONDUCTOR DIV	CONCORD NH	03301
16546	U S CAPACITOR CORP	BURBANK CA	91504
17540	ALPHA INDUSTRIES INC	WOBURN MA	01801
17856	SILICONIX INC	SANTA CLARA CA	95054
18324	SIGNETICS CORP	SUNNYVALE CA	94086
19701	MEPCO/ELECTRA CORP	MINERAL WELLS TX	76067
20932	EMCON DIV ITW	SAN DIEGO CA	92129
22526	BERG ELEK DIV DUPONT	NEW CUMBERLAND PA	17070
24046	TRANSITRON ELECTRONIC CORP	WAKEFIELD MA	01880
24546	CORNING GLASS WORKS (BRADFORD)	BRADFORD PA	16701
25088	SIEMENS CORP	ISELIN NJ	08830
26654	VARADYNE INC	SANTA MONICA CA	90404
27014	NATIONAL SEMICONDUCTOR CORP	SANTA CLARA CA	95051
27167	CORNING GLASS WORKS (WILMINGTON)	WILMINGTON NC	28401
28480	HEWLETT-PACKARD CO CORPORATE HQ	PALO ALTO CA	94304
31585	RCA CORP SOLID STATE DIV	SOMERVILLE NJ	
32293	INTERSIL INC	CUPERTINO CA	95014
32997	BOURNS INC TRIMPOT PROD DIV	RIVERSIDE CA	92507
34371	HARRIS SEMICON DIV HARRIS-INTERTYPE	MELBOURNE FL	32901
51642	CENTRE ENGINEERING INC	STATE COLLEGE PA	16801
51959	VICLAN INC	SAN DIEGO CA	92138
52063	EXAR INTEGRATED SYSTEMS INC	SUNNYVALE CA	94086
56289	SPRAGUE ELECTRIC CO	NORTH ADAMS MA	01247
71400	BUSSMAN MFG DIV OF MCCRAW-EDISON CO	ST LOUIS MO	63107
73138	BECKMAN INSTRUMENTS INC HELIPOT DIV	FULLERTON CA	92634
74970	JOHNSON E F CO	WASECA MN	56093
75915	LITTELFUSE INC	DES PLAINES IL	60016
8M498	JOHANSON DIELECTRICS INC	BURBANK CA	91510

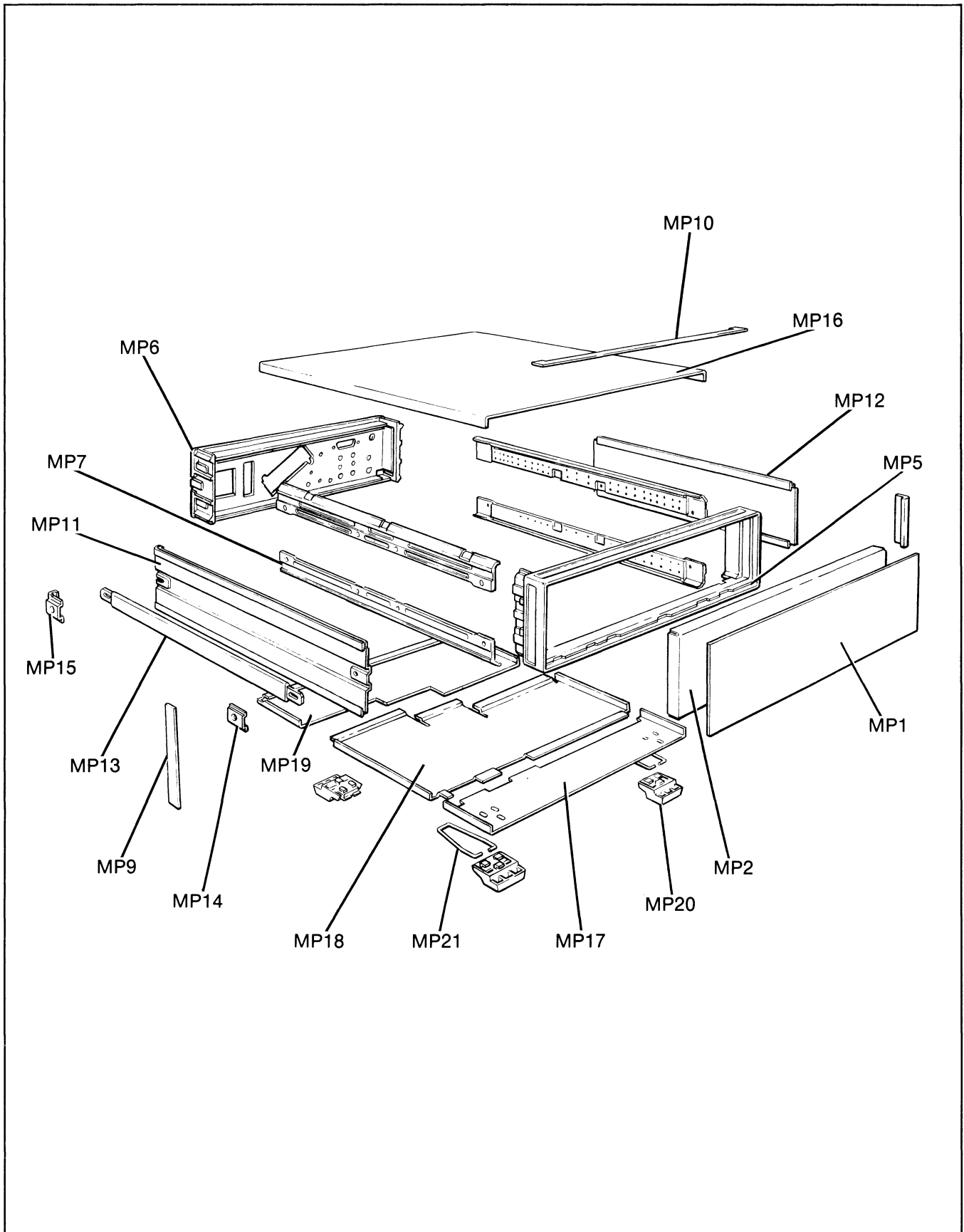

Figure 6-1. Cabinet Parts

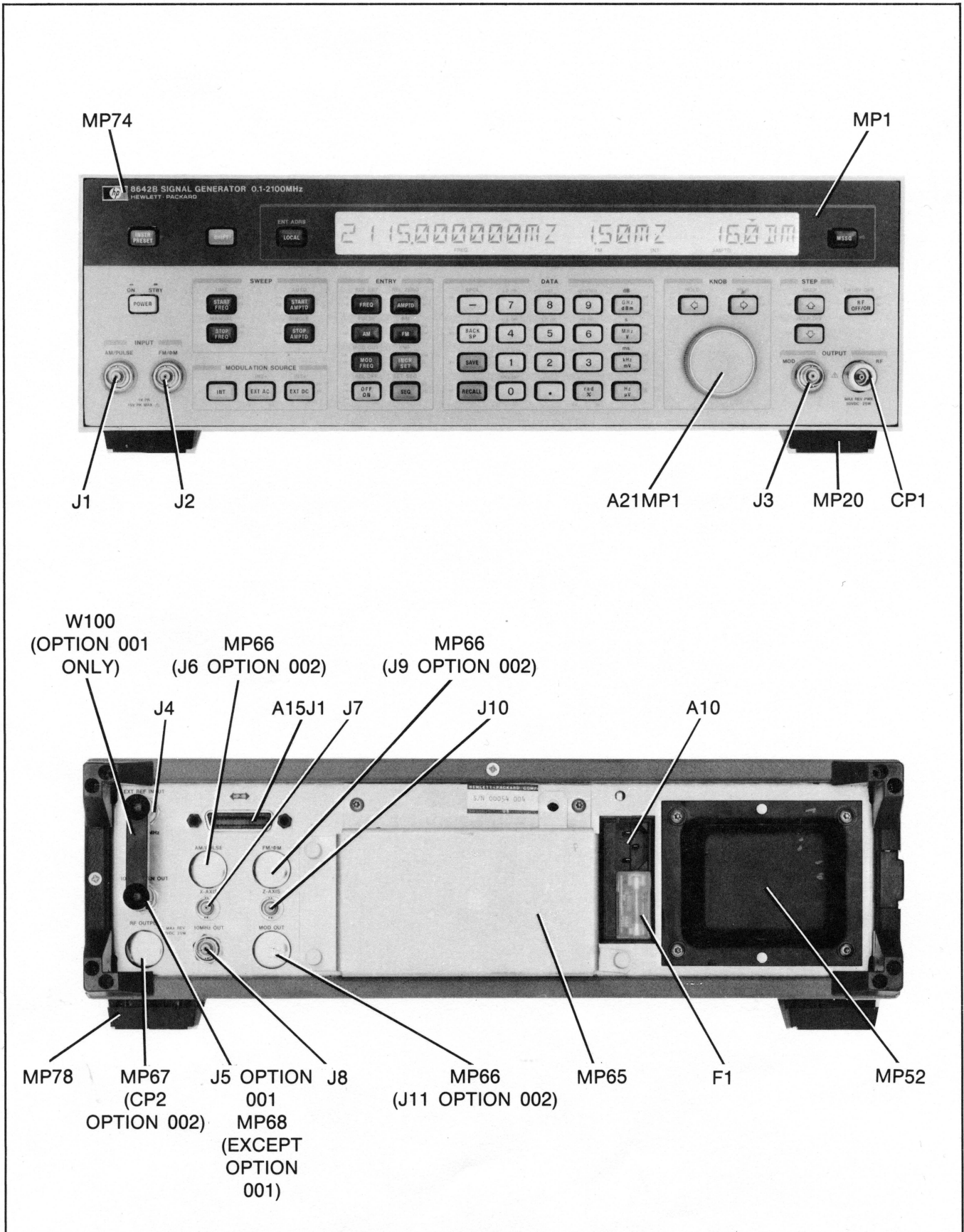

Figure 6-2. Front and Rear Panel Parts Identification

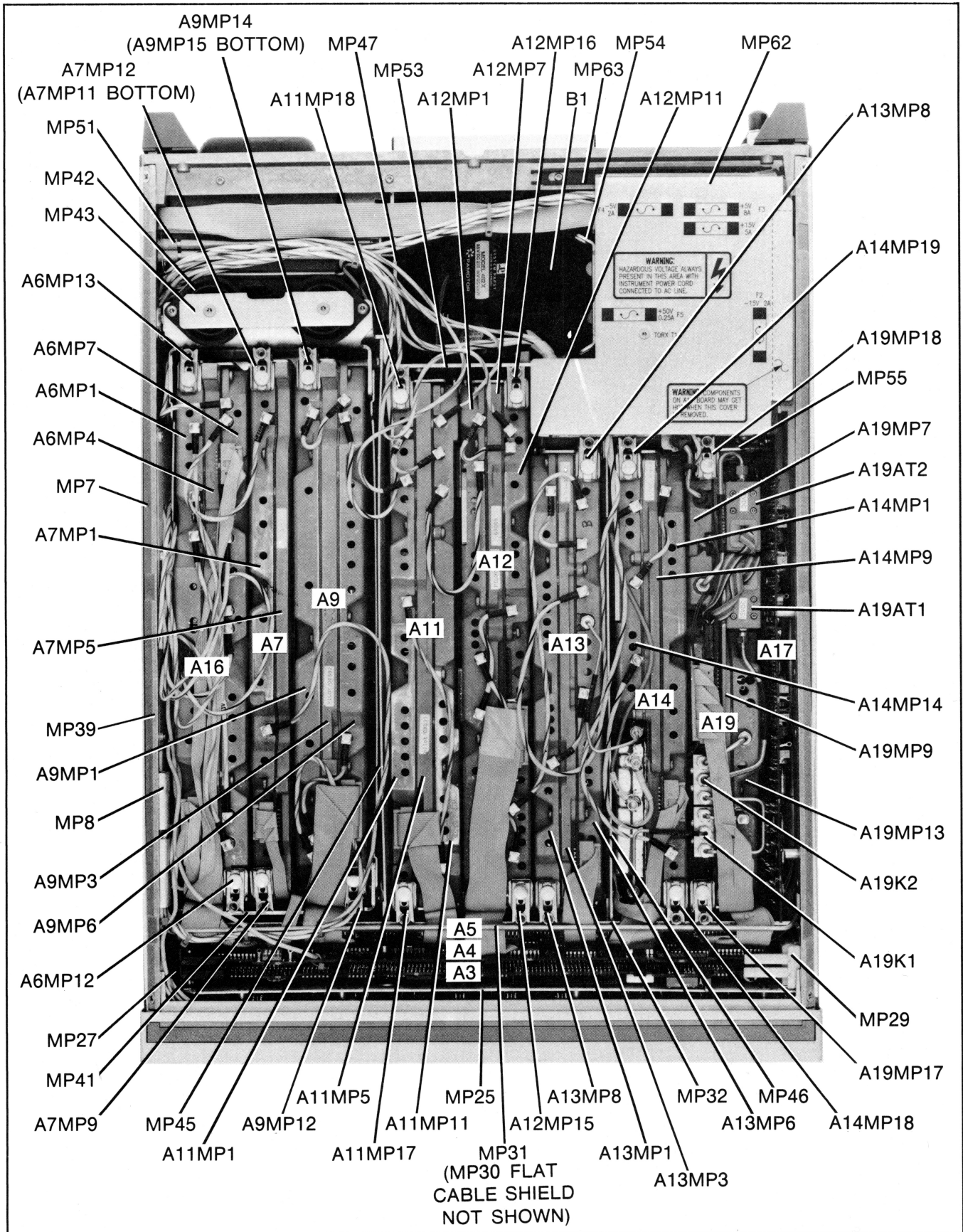

Figure 6-3. Top Internal View Parts Identification

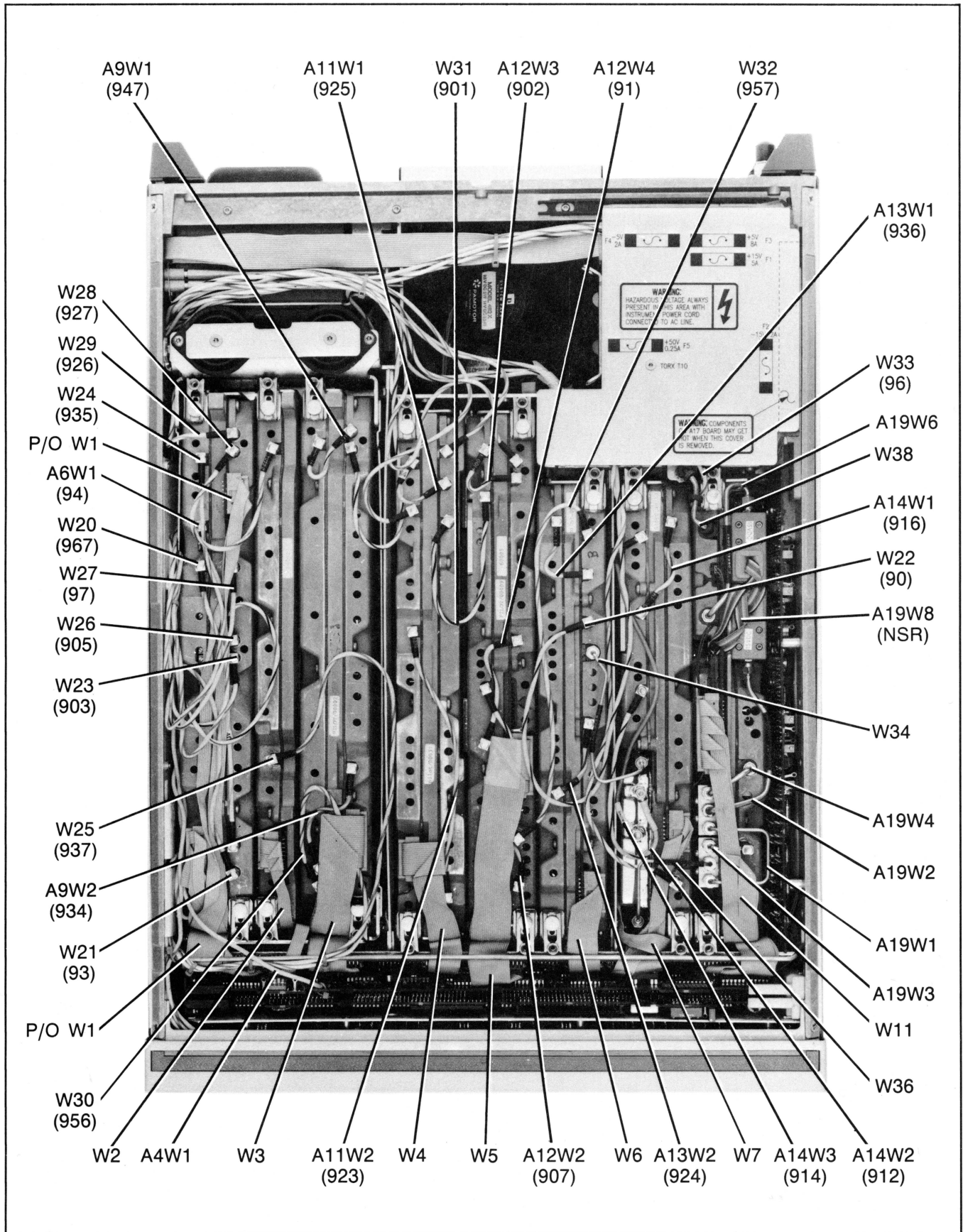

Figure 6-4. Top Internal View Cable Identification

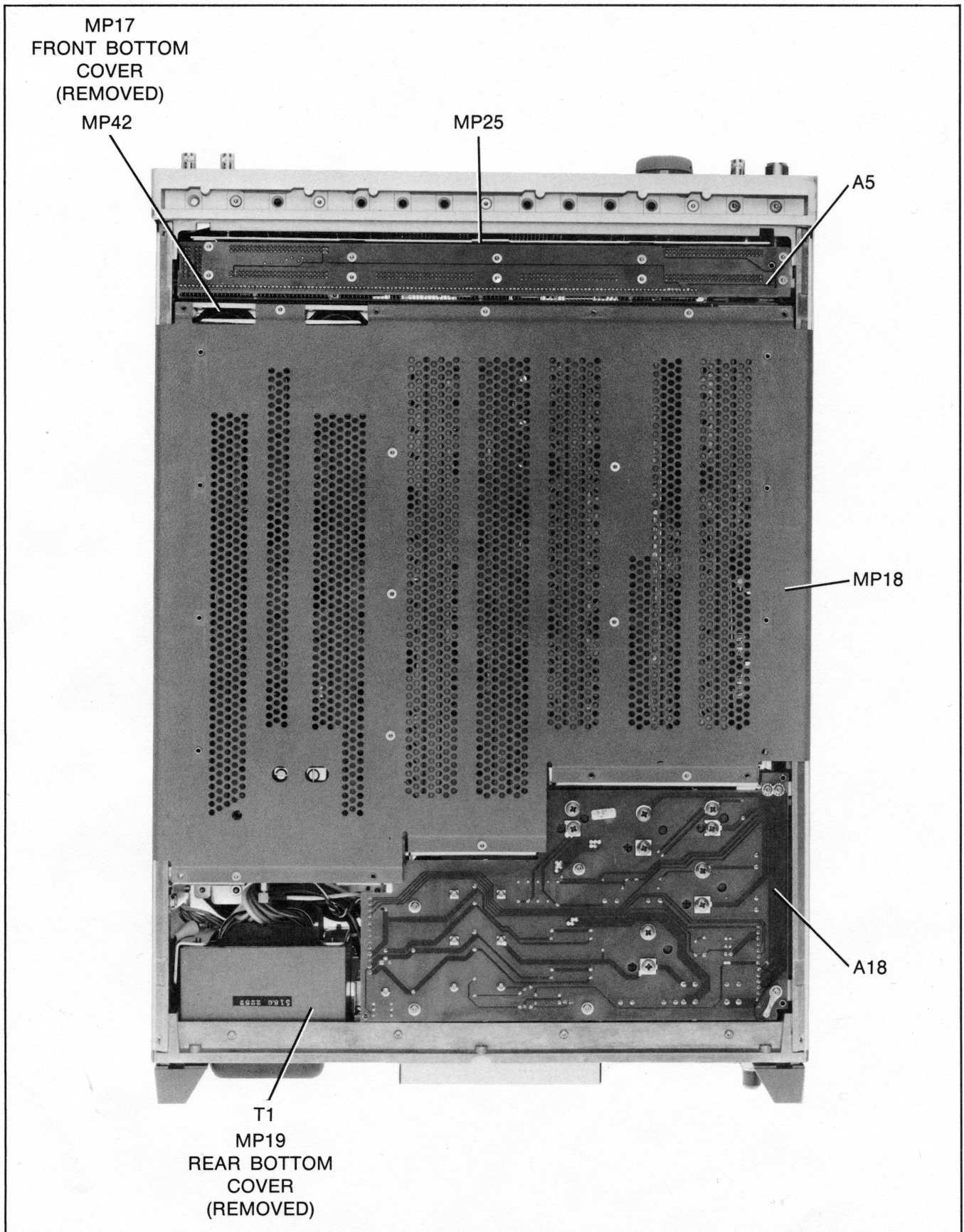

Figure 6-5. Bottom Internal View Parts Identification



## Section 7 INSTRUMENT CHANGES

### 7-1. INTRODUCTION TO THIS SECTION

This section contains instrument modification recommendations and procedures that could improve the performance and reliability of your instrument. Refer to *Instruments Covered by This Manual*, paragraph 1-12 in Section 1 for important information about serial number coverage.

### 7-2. CABINET PARTS COLOR CHANGE

*(2930A and above)*

Serial prefix 2930A changes the color of the instrument covers and accessories. The old color cover and accessories are no longer available. If your instrument has serial prefixes 2927A and below (8642A only) or 2816A and below (8642B only), and you must replace one of these parts, we recommend that you order the full set of covers and accessories. Affected cabinet parts are MP1, MP9-10, MP12-16, MP18, MP19-20, and, MP78 (see Table 6-2).

### 7-3. A16 ATTENUATOR MODULE

*(2427A to 2941A)*

Serial prefix 3005A replaces the A16 Attenuator Module with HP Part 08642-60848 (08642-69848 restored). If you need to replace A16 and the Serial Prefix is 2427A to 2941A, order the part numbers listed above.





## SECTION VIII

### SERVICE

#### 8-1. INTRODUCTION

The following General Service Information will prepare you for success in repairing the HP 8642. By reading through this brief section you will:

- Understand the troubleshooting philosophy that the manual is designed to support.
- Become aware of safety hazards and the precautions you must take to prevent injury to yourself and others. You will also learn procedures on how to protect this instrument from inadvertent damage.
- Understand how the service portion of the manual is organized.
- Know what tools and equipment you will need for servicing the instrument.

#### 8-2. TROUBLESHOOTING

##### General

The troubleshooting procedures in this manual are designed to identify and isolate failures. Following the steps as outlined will provide you with a troubleshooting strategy designed for successful instrument repair. The process used is divided into four steps.

1. Identification of Failures
2. Instrument Troubleshooting
3. Module Troubleshooting
4. Service Sheet (component) Troubleshooting

##### Step 1. Identification of Failures

Before attempting to isolate a failure, it should first be identified as: operator error, performance degradation, or a catastrophic failure.

##### Operator Error

The HP 8642 will recognize many operator errors through the internal controller. The display will prompt the user/operator when this occurs. The operating section can also help identify operator errors. As a final check for operator errors, compare two HP 8642s. If both instruments perform similarly, suspect an operator error.

### Performance Degradation

Performance degradation should be confirmed using methods and specifications found in Performance Tests (Section IV). Be sure the test equipment meets or exceeds critical specifications outlined in Section I. Use the information obtained to determine a potentially faulty module. If possible, substitute a known good module for the suspected module and repeat the test that indicated a problem.

### Catastrophic Failures

Most catastrophic failures will be detected by the HP 8642's diagnostic hardware or firmware. Hardware failures will cause a blinking message to be displayed. The message can be viewed by pressing the **MSSG** key on the front panel. Multiple hardware failure messages are normally observed when an HP 8642 is not operating correctly. This is due to a ripple effect in the feed-forward design of the instrument. After verification of a catastrophic failure, proceed to instrument troubleshooting.

### Step 2. Instrument Troubleshooting

Isolating a catastrophic failure to a single module is called Instrument Troubleshooting. Begin Instrument Troubleshooting by opening the manual to the Diagnostics Tab. The goal in troubleshooting at the instrument level is to rapidly locate a faulty module or interconnection. Using these procedures, you should succeed in isolating a faulty module more than 80% of the time. There is a portion of the diagnostics that provides information helpful in dealing with the remaining 20%. It is called Exceptional Cases and is included as a subset of the diagnostic procedures. After a faulty module has been isolated, proceed to module troubleshooting.

### Step 3. Module Troubleshooting

Begin by turning to the tab that lists the module known to be faulty. (All modules are tabbed and are located in Volumes 3 and 4.) These procedures are designed to isolate a fault in a module that is *known* to be the cause of some type of instrument failure. The goal at this level is to identify the Service Sheet that will provide the information necessary for repair. This is accomplished by using the module troubleshooting procedure, simplified block diagram, module block diagram, and module test point/adjustment locations. See Table 8-1 (page 1 of 8). After following this procedure, Service Sheet troubleshooting is used to isolate the fault to a component or components.

### Step 4. Service Sheet (Component) Troubleshooting

After a fault has been isolated to the Service Sheet level, the techniques employed to diagnose and repair are left to the service person. The schematics have all circuitry in functional blocks with main feed forward signal paths starting on the left side and going to the right. Feedback paths are shown with dashed lines and have arrows showing direction of signal. This is done to help the service person isolate a faulty component using conventional troubleshooting methods (such as the half splitting method). For an explanation of Service Sheet format, see Table 8-3 (pages 1 and 2 of 8).

**8-3. SAFETY CONSIDERATIONS****COMMENT**

*These safety considerations are part of an effort to inform you of potential health hazards you may encounter while servicing this instrument. Some are simply common sense precautions that apply to all instruments. Others are peculiar to this instrument and need to be brought to your attention. Please read through this section carefully and thoroughly. We are concerned with your safety.*

**Before Applying Power to Instrument**

Verify that the instrument is set to match the line voltage being used and that the correct fuse is installed. An uninterrupted safety earth ground must be provided from the main power source to the instrument input wiring terminals, power cord, or supplied power cord set. (Refer to Section II.)

**Warnings and Cautions**

Pay attention to WARNINGS and CAUTIONS. They must be followed for your protection and to avoid damage to the equipment.

**WARNING**

*Transistor A13Q3 contains beryllium oxide ( $\text{BeO}_2$ ), a highly toxic compound. The compound is formed into a pellet which unless ground or crushed into a powder, is completely safe. If the transistor is damaged in a way such that the pellet is no longer intact, do not inhale the beryllium oxide dust and dispose of this component.*

*Maintenance described herein is performed with power supplied to the instrument and with the protective covers removed. Such maintenance should be performed only by service-trained personnel who are aware of the hazards involved (for example, fire and electrical shock). Where maintenance can be performed without power supplied, the power should be removed.*

**WARNING**

*Any interruption of the protective (grounding) conductor (inside or outside the instrument) or disconnection of the protective earth terminal will create a potential shock hazard that could result in personal injury. Grounding one conductor of a two conductor outlet is not sufficient. Whenever it is likely that the protection has been impaired, the instrument must be made inoperative (i.e., secured against unintended operation).*

*If this instrument is to be energized via an autotransformer, make sure that the autotransformer's common terminal is connected to the earth terminal of the power source.*

*Capacitors inside the instrument can still be charged even if the instrument is disconnected from its source of supply.*

*Make sure that only 250 volt fuses with the required rated current and of the specified type (normal blow, time delay, etc.) are used for replacement. Do not use repaired fuses or shortcircuited fuses to do so would create a shock or fire hazard.*

*For continued protection against fire hazard, replace the line fuse(s) only with 250V fuse(s) of the same current rating and type (for example, normal blow, time delay, etc.). Do not use repaired fuses or short circuited fuseholders.*

*The left rear portion of the chassis becomes hot during operation. A cooling period may be desired before servicing modules in this area.*

*To avoid personal injury, avoid contact with the A17 heatsink when the A17 Module is extended.*

*The HP 8642 is extremely heavy. Do not lift or carry the instrument without assistance. If the instrument is rack-mounted, do not pull the instrument from the rack without assistance.*

**CAUTION**

*Do not disconnect or remove any modules in the Signal Generator unless the instrument is unplugged. Some boards contain devices which can be damaged if the board is removed when the power is on. Use conductive foam when removing MOS devices from sockets. Use care when unplugging ICs from high-grip sockets.*

*The Signal Generator top cover directs cooling airflow and prolonged operation with inadequate airflow could result in instrument damage, therefore, the top cover should be removed only for repair and then promptly replaced.*

## 8-4. COMPONENT HANDLING PRECAUTIONS

### Component Replacement Procedures

The instrument's printed circuit boards are manufactured using a Hot Air Leveled (HAL) process. The printed circuit board traces, pads and plated-through holes (PTH) are copper. While the process has several advantages over conventional processes, the printed circuit boards are more susceptible to broken traces, lifted pads and damage to the plated-through holes. Therefore, additional care must be taken when replacing components on HAL printed circuit boards.

Listed below are soldering considerations that apply to all printed circuit boards:

- The temperature of the soldering iron tip and time the tip is in contact with the printed circuit board.
- The size and shape of the soldering iron tip.
- The pressure of the soldering iron tip on the pad.
- The operator's skill.

When replacing components on HAL printed circuit boards the following steps should be taken.

1. Use a temperature controlled soldering iron set at a temperature of 600° F (315° C).

Extensive tests were made by Hewlett-Packard using commercial brands of soldering irons. As a result of these tests, the recommended soldering iron was the HEXACON THERM-O-TRAC STATION #1000 with the FINGER GRIP SLEEVE 21 A-5 and solder tip #J 301X. During soldering, the tip temperature of the HEXACON THERM-O-TRAC STATION remained very stable.

2. Cut out the body of the component to be removed. (Leave leads as long as possible for easier removal.)
3. Apply heat to the lead only. Adding solder as required, slide the tip down to the pad and remove solder with solder sucker.



*Tip pressure on the pad is most critical and is totally operator dependent. Excessive tip pressure will damage or destroy the board. Do not use tin desoldering braid or solder wicking techniques on Hot Air Leveled boards.*

The melting point of solder in the plated through hole (PTH) is reached in 2.5 seconds at tip temperature of 600° to 750° F (315° to 400° C). The *recommended* time for heat to be applied is 3 seconds.

Keep the solder sucker clean and **do not** let the tip of the solder sucker hit the pad when removing solder. Breaking the lead loose can damage the PTH. If the lead is attached to the PTH after the solder has been removed, reheat the lead to remove it.

4. When soldering or desoldering multilead components, **do not** consecutively apply heat to adjacent leads. Instead, distribute heat by skipping leads or crossing to opposite side of device.

### Static Sensitive Devices

This instrument has been assembled in an ESD protected environment. It is important that you read the following information so that you may also prevent ESD damage to the instrument.

Static Sensitive Devices are electronic components that are susceptible to damage or complete destruction in the presence of a static discharge. While all electronic components are static sensitive to some degree, the possibility of damage due to electro-static discharge (ESD) becomes greater as the insulating materials in the components become thinner and as component densities increase. Depending on the magnitude of the charge, device substrates can be punctured or destroyed by contact or **mere proximity** of a static charge.

Static charges accumulate harmlessly in a person's body, therefore the charges can be passed on in numerous ways such as simple contact with the device, during separation of materials, or during normal destructive static discharges (<4000 V). Often static discharges cannot be seen or felt. The damage which may result from these charges can cause degradation of device performance, early failure, or complete destruction of the device.

All schematics with circuit assemblies containing static sensitive components are designated with the international awareness symbol. This symbol indicates that special precautions apply when servicing these circuits.

Following the precautions listed below will prevent damage to the circuit board and its components.



- a. Use metal or conductive plastic wriststraps with a 1 Megohm series resistor connected to ground.

- b. Packages should not be removed from their conductive or antistatic carriers until required and should only be removed by an operator that is grounded through a 1 Megohm series resistor. Devices that are removed should be placed in a conductive tray.
- c. Metal parts of fixtures, tools, soldering irons, and table tops should be grounded to a common point.
- d. Handling equipment, trays, table tops, and transport carts should be electrically conductive.
- e. The circuit board should have a conductive strip placed on its connectors to short all the connections together.

### Device Classes

The following is a classification of the ESD sensitivity of components used in most Hewlett-Packard instruments:

**CLASS I devices have a sensitivity range from 0 to 1000 volts.** Devices in this range include microwave diodes (especially Schottky), BIFET and precision OP AMP ( $I_{OS} < 50$  nA,  $V_{OS} < 1$  mV), unprotected MOS (especially VLSI), MOS capacitors, advanced Schottky logic, junction FETs and low current SCRs ( $< 1.5$  A), microwave and VHF transistors and ICs, precision IC voltage regulators and resistors, low power resistors ( $< 0.05$  W), VLSICs with dual-level metalization, and Surface Acoustic Wave (SAW) devices.

**CLASS II devices have a sensitivity range from 1000 to 4000 volts.** Devices in this range include MOS ICs with internal protection (CMOS, NMOS, PMOS) and LSI ICs, Schottky rectifier diodes, linear ICs (bipolar), precision resistor networks, high speed bipolar logic (ECL, LS-TTL, S-TTL), varactor diodes, monolithic ceramic capacitors, RF Mixers and other RF devices utilizing diodes.

**CLASS III devices have a sensitivity range from 4000 to 15000 volts.** Devices in this range include small signal diodes, and transistors, low-speed bipolar logic (TTL, DTL), quartz and piezoelectric crystals, and thin and thick film resistors ( $< 1/8$  W,  $\geq 500$  k ohms).

### 8-3. TABS

Section VIII contains information for troubleshooting and repairing the Signal Generator. Located under tabs are:

#### General Service Information

Under the **GENERAL SERVICE INFORMATION** tab, you will find important information regarding your safety while servicing the instrument. Precautions necessary for protection of the instrument are covered under Component Handling Precautions. You will also find an explanation of service equipment and aids available, and troubleshooting tips.



### **Disassembly Procedures**

Under the **MECHANICAL ASSEMBLY/DISASSEMBLY** tab you will find the information you need to correctly remove and replace instrument assemblies.

### **Instrument Block Diagram**

Under this tab is a highly simplified Block Diagram of the Signal Generator. Its purpose is to provide a conceptual overview of the operating principles and to aid in isolating a fault to a single module.

### **Diagnostics**

Under the **DIAGNOSTICS** tab are the procedural steps for isolating a fault in the Signal Generator to a single module. Internal (microprocessor initiated) diagnostics are used in conjunction with troubleshooting fundamentals to perform this level of service.

### **Module Level Service (All tabs beginning A\_\_\_)**

Under each tab in the module level service are the block diagram, schematics, and all service information pertaining specifically to the module or modules listed on that tab. Before proceeding to this level of troubleshooting a high probability that the correct (faulty) module has been identified should exist. The procedural steps given in diagnostics will provide this high probability.

## **8-5. SERVICE EQUIPMENT**

Test equipment and test accessories required to maintain the Signal Generator are listed in the table of Recommended Test Equipment in Section I. If any of the recommended test equipment is unavailable, instruments meeting minimum specification may be substituted. Refer to Section I.

### **Service Tools**

#### **Tools Provided in the Instrument**

Two Torx bits are located in bracket mounted to the transformer (T1). The Torx bits will fit a 1/4 inch hex drive.

Module extender posts are provided in the tool bracket attached to the transformer (T1). Refer to Assembly/Disassembly procedure for information on use of extender posts.

An RF connector wrench is attached to the metal bracket to the right of the fan. A fuse extraction/insertion tool is located on top of the rear frame of instrument near the fan.

## Other Tools

**Torque Drivers and Torx Bits.** Most screws in the instrument are Torxhead screws. They require a torque wrench and Torxhead bits for proper removal and installation. HP Part Number for T-10 Torx bit is 8710-1493. HP Part Number for T-15 Torx bit is 8710-1465. HP Part Number for torque wrench is 8730-0012.



*To avoid damage, do not exceed the following torque limits:*

*Torque limit for 4 mm screws: 2.2 Nm. (Use bit T-15)*

*Torque limit for 3 mm screws: 1.5 Nm. (Use bit T-10)*

To set the torque limit of the wrench, remove cover from end of handle. Lift key to the vertical position and turn clockwise to increase torque setting or counter-clockwise to decrease torque setting. Align hairline on clear bulb of wrench shaft with the desired setting. Push the key back to the flat position (a very slight turn in either direction may be necessary for key to lock into place).

**Pozidriv Screwdrivers.** Screws in the Signal Generator that appear to be Phillips type, are not. To avoid damage to the screw slots, Pozidriv screwdrivers should be used. HP 8710-0899 is the No. 1 Pozidriv. HP 8710-0900 is the No. 2 Pozidriv.

**Tuning Tools.** For adjustments requiring non-metallic tuning tools, use the HP 8710-0033 blade tuning tool or the HP 8710-1010 (JFD Model No. 5284) hex tuning tool. For other adjustments an ordinary small insulated screwdriver or suitable tool is sufficient. No matter which tool is used, never force any adjustment control. This is especially critical when adjusting variable inductors or capacitors.

**Heat Staking Tool.** The front-panel pushbutton switches have small plastic pins protruding from the back. These tabs fit through holes in the keyboard printed circuit board and are melted down to hold the switch in place. This process is known as heat staking. The heat staking tool is a standard soldering iron with a special tip attached (HP part numbers for the heat staking tools: solder iron tip 5020-8160, special support anvil 5040-6882.)

**Service Kits.** The 8642A/B has two Service Kits that assist in repair, an On-Site Service Kit and a Bench Service Kit.

The On-Site Service Kit is designed to assist in rapid repair for critical up-time applications. This kit contains all modules needed to restore operation to an instrument. The On-Site Service Kit contains its own manual. One On-Site kit should support a minimum of 25 instruments if properly maintained. Part Numbers for the On-Site Kit are as follows:

8642A only	11801A
8642B only	11801B
8642A and B	11801C

See Table 1-5 for a complete listing of On-Site Service Kit contents.

The Bench Service Kit contains extender boards, troubleshooting tools, and adapters for bench level component troubleshooting. See Table 1-6 for a detailed listing of its contents.

### **Top Cover**

Assembly locations in the Signal Generator are shown on the inside of the Top Cover of the Signal Generator. There is also a table of cable Designations showing connect points for each cable.

### **8-6. BASIC LOGIC SYMBOLOGY**

The symbols used in this manual are based on the Institute of Electrical and Electronic Engineers (IEEE) IEEE-STD 91-1984, "Graphic Symbols for Logic Functions". This publication may be purchased from:

Institute of Electrical and Electronic Engineers Inc.  
345 East 47th Street  
New York, N.Y. 10017

There is also an "Explanation of New Logic Symbols" section in Volume I of Texas Instruments TTL Data Book, Vol. 1, 1984. For a listing of combinational and sequential logic functions, dependency notation, and miscellaneous logic functions, see Table 8-1 (pages 5 through 8 of 8).

Table 8-3. Schematic Diagram Notes (1 of 8)

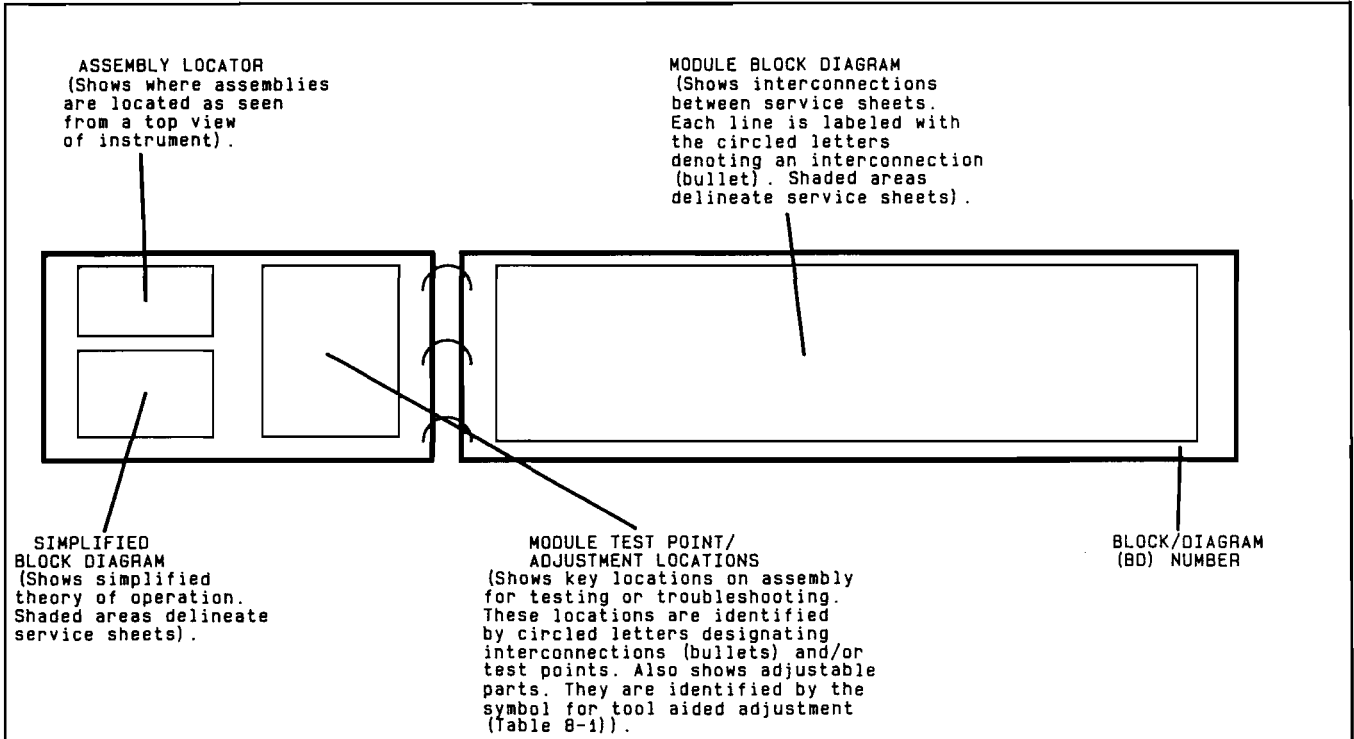

**BLOCK DIAGRAM (BD) FORMAT**

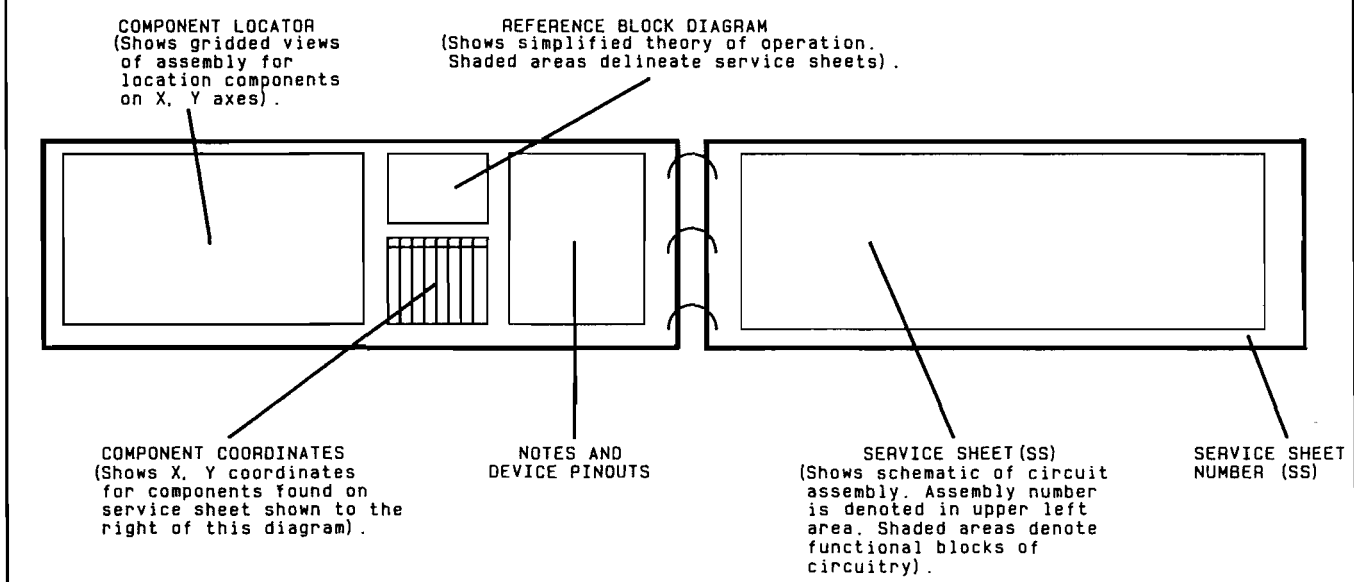

**SERVICE SHEET (SS) FORMAT**

Table 8-3. Schematic Diagram Notes (2 of 8)

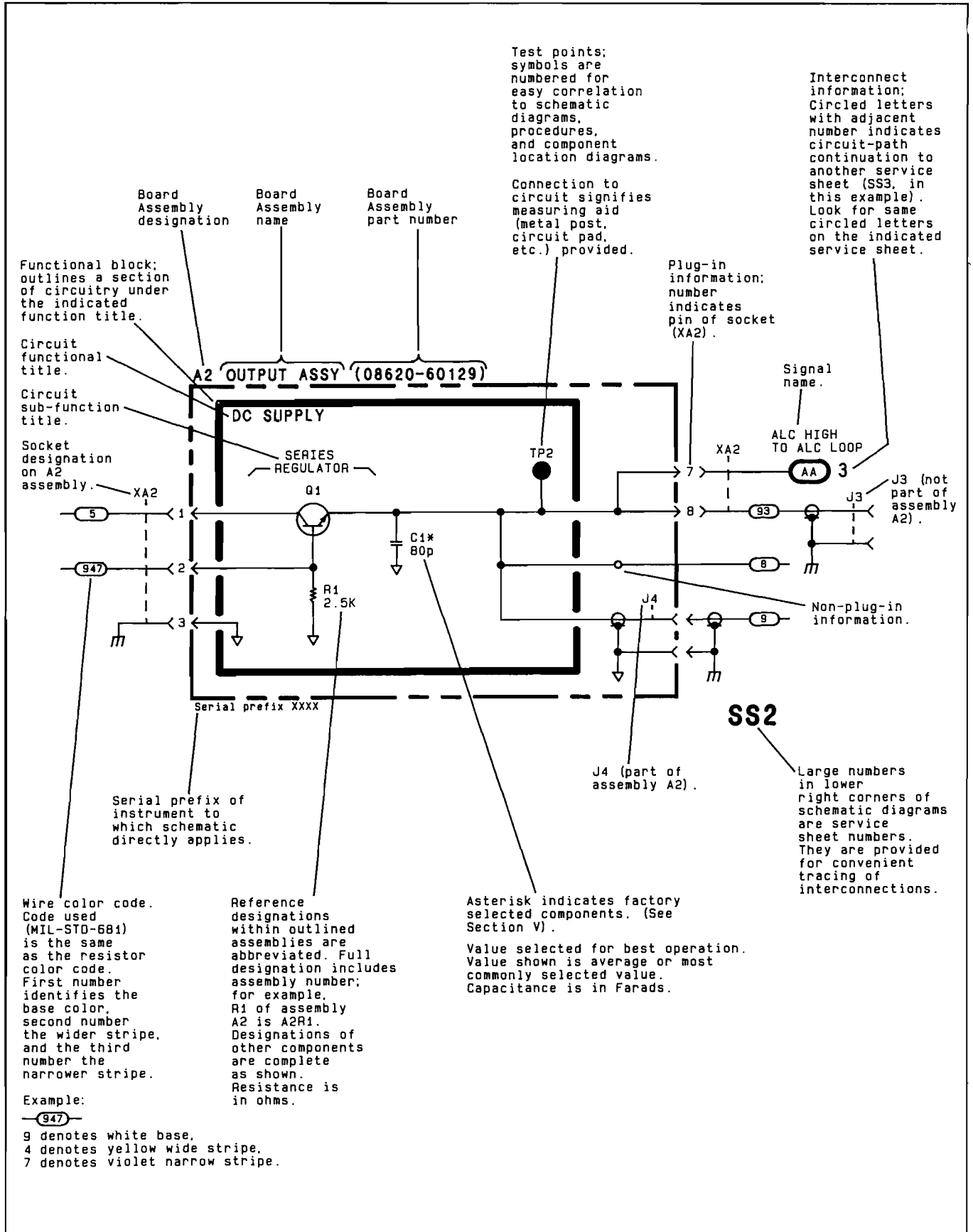

Functional block:  
outlines a section  
of circuitry under  
the indicated  
function title.

Circuit  
functional  
title.

Circuit  
sub-function  
title.

Socket  
designation  
on A2  
assembly.

Wire color code.  
Code used  
(MIL-STD-681)  
is the same  
as the resistor  
color code.  
First number  
identifies the  
base color,  
second number  
the wider stripe,  
and the third  
number the  
narrower stripe.

Example:

947

9 denotes white base,  
4 denotes yellow wide stripe,  
7 denotes violet narrow stripe.

Reference  
designations  
within outlined  
assemblies are  
abbreviated. Full  
designation includes  
assembly number;  
for example,  
R1 of assembly  
A2 is A2R1.  
Designations of  
other components  
are complete  
as shown.  
Resistance is  
in ohms.

Test points:  
symbols are  
numbered for  
easy correlation  
to schematic  
diagrams,  
procedures,  
and component  
location diagrams.

Connection to  
circuit signifies  
measuring aid  
(metal post,  
circuit pad,  
etc.) provided.

Plug-in  
information:  
number  
indicates  
pin of socket  
(XA2).

Interconnect  
information:  
Circled letters  
with adjacent  
number indicates  
circuit-path  
continuation to  
another service  
sheet (SS3, in  
this example).  
Look for same  
circled letters  
on the indicated  
service sheet.

Signal  
name.

ALC HIGH  
TO ALC LOOP

J3 (not  
part of  
assembly  
A2).

Non-plug-in  
information.

SS2

Large numbers  
in lower  
right corners  
of schematic  
diagrams are  
service  
sheet numbers.  
They are provided  
for convenient  
tracing of  
interconnections.

Asterisk indicates factory  
selected components. (See  
Section V).

Value selected for best operation.  
Value shown is average or most  
commonly selected value.  
Capacitance is in Farads.

Table 8-3. Schematic Diagram Notes (3 of 8)

Values for all components are marked in units of farads, henries, and ohms unless otherwise specified.



















*	Asterisk denotes a factory-selected value. Value shown is typical.
	Tool-aided adjustment.
	Manual control.
	Encloses front-panel designation.
	Encloses rear-panel designation
	Circuit assembly borderline.
	Other assembly borderline.
	Heavy line with arrows indicates path and direction of main signal.
	Heavy dashed line with arrows indicates path and direction of main feedback.
	Indicates stripline (i.e., RF transmission line above ground).
	Wiper moves toward cw with clockwise rotation of control (as viewed from shaft or knob).
	Numbered Test Point measurement aid provided.
	Encloses wire or cable color code. Code used is the same as the resistor color code. First number identifies the base color, second number identifies the wider stripe, and the third number identifies the narrower stripe, e.g., <b>947</b> denotes white base, yellow wide stripe, violet narrow stripe.
	A direct conducting connection to earth, or a conducting connection to a structure that has a similar function (e.g., the frame of an air, sea, or land vehicle).
	A conducting connection to a chassis or frame.
	Common connections. All like-designation points are connected.
	Letter = off-page connection. Number = Service Sheet number for off-page connection. In the example, signal flow is continued on Service Sheet 12, at the point marked
	Number (only) = on-page connection.
	Step recovery diode.

Table 8-3. Schematic Diagram Notes (4 of 8)

	<p>Indicates multiple paths represented by only one line. Letters or names identify individual paths. Numbers indicate number of paths represented by the line.</p>
	<p>Coaxial or shielded cable.</p>
	<p>Ferrite bead. (Increases the self-inductance of the conductor passing through the bead.)</p>
	<p>Relay. Contact moves in direction of arrow when energized.</p>
	<p>Indicates a pushbutton switch with a momentary (ON) position.</p>
	<p>Capacitive feedthrough filter. (Acts as a feedthrough terminal.)</p>
	<p>Indicates a PIN diode.</p>
	<p>Indicates a current regulation diode.</p>
	<p>Indicates a voltage regulation diode.</p>
	<p>Indicates a capacitive (varactor) diode.</p>
	<p>Indicates a Schottky (hot-carrier) diode.</p>
	<p>Light-emitting diode.</p>
	<p>Multiple transistors in a single package—physical location of the pins is shown in Notes section.</p>
	<p>Identification of logic families as shown (in this case, ECL).</p>
	<p>Coaxial connectors.</p>

Table 8-3. Schematic Diagram Notes (5 of 8)

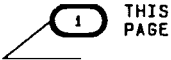
**DIGITAL SYMBOLOGY REFERENCE INFORMATION**

**Combinational Logic Symbols and Functions**

$\Sigma$	Summing Junction—Outputs added together at a common point.
&	AND—All inputs must be active for the output to be active.
$\geq 1$	OR—One or more inputs being active will cause the output to be active.
$\geq m$	Logic Threshold—m or more inputs being active will cause the output to be active (replace m with a number).
=1	EXCLUSIVE OR—Output will be active when one (and only one) input is active.
=m	m and only m—Output will be active when m (and only m) inputs are active (replace m with a number).
=	Logic Identity—Output will be active only when all or none of the inputs are active (i.e., when all inputs are identical, output will be active).
	Amplifier—The output will be active only when the input is active (can be used with polarity or logic indicator at input or output to signify inversion).
X/Y	Signal Level Converter—Input level(s) are different than output level(s).
	Bilateral Switch—Binary controlled switch which acts as an on/off switch to analog or binary signals flowing in both directions. Dependency notation should be used to indicate affecting/affected inputs and outputs. Note: amplifier symbol (with dependency notation) should be read to indicate unilateral switching.
X→Y	Coder—Input code (X) is converted to output code (Y) per weighted values or a table.
(Functional Labels)	The following labels are to be used as necessary to ensure rapid identification of device function.
MUX	Multiplexer—The output is dependent only on the selected input.
DEMUX	Demultiplexer—Only the selected output is a function of the input.
CPU	Central Processing Unit



Table 8-3. Schematic Diagram Notes (6 of 8)

## DIGITAL SYMBOLOGY REFERENCE INFORMATION

**Sequential Logic Functions**

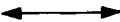
Monostable—Single shot multivibrator. Output becomes active when the input becomes active. Output remains active (even if the input becomes inactive) for a period of time that is characteristic of the device and/or circuit.



Oscillator—The output is a uniform repetitive signal which alternates between the high and low state values. If an input is shown, then the output will be active if an only if the input is in the active state.

FF

Flip-Flop—Binary element with two stable states, set and reset. When the flip-flop is set, its outputs will be in their active states. When the flip-flop is reset, its outputs will be in their inactive states.

T

Toggle Input—When active, causes the flip-flop to change states.

S

Set Input—When active, causes the flip-flop to set.

R

Reset Input—When active, causes the flip-flop to reset.

J

J Input—Analogous to set input.

K

K Input—Analogous to reset input.

D

Data Input—Always enabled by another input (generally a C input—see Dependency Notation). When the D input is dependency-enabled, a high level at D will set the flip-flop; a low level will reset the flip-flop. Note: strictly speaking, D inputs have no active or inactive states—they are just enabled or disabled.

+m

Count-Up Input—When active, increments the contents (count) of a counter by “m” counts (m is replaced with a number).

-m

Count-Down Input—When active, decrements the contents (count) of a counter by “m” counts (m is replaced with a number).

→m

Shift Right (Down) Input—When active, causes the contents of a shift register to shift to the right or down “m” places (m is replaced with a number).

←m

Shift Left (Up) Input—When active, causes the contents of a shift register to shift to the left or up “m” places (m is replaced with a number).

**NOTE**

*For the four functions shown above, if m is one, it is omitted.*

(Functional Labels)

The following functional labels are to be used as necessary in symbol build-ups to ensure rapid identification of device function.

mCNTR

Counter—Array of flip-flops connected to form a counter with modules m (m is replaced with a number that indicates the number of states: 5 CNTR, 10 CNTR, etc.).

Table 8-3. Schematic Diagram Notes (7 of 8)

**DIGITAL SYMBOLOGY REFERENCE INFORMATION****Sequential Logic Functions (Cont'd)**

REG	Register—Array of unconnected flip-flops that form a simple register or latch.
SREG	Shift Register—Array of flip-flops that form a register with internal connections that permit shifting the contents from flip-flop to flip-flop.
ROM	Read Only Memory—Addressable memory with read-out capability only.
RAM	Random Access Memory—Addressable memory with read-in and read-out capability.

**Dependency Notation**

Cm	Control Dependency—Binary affecting input used where more than a simple AND relationship exists between the C input and the affected inputs and outputs (used only with D-type flip-flops).
Gm	Gate (AND) Dependency—Binary affecting input with an AND relationship to those inputs or outputs labeled with the same identifier. The m is replaced with a number or letter (the identifier).
Vm	OR Dependency—Binary affecting input with an OR relationship to those inputs or outputs labeled with the same identifier. The m is replaced with a number or the letter (the identifier).
mAm	Address Dependency—Binary affecting inputs of affected outputs. The m prefix is replaced with a number that differentiates between several address inputs, indicates dependency, or indicates demultiplexing of address inputs and outputs. The m suffix indicates the number of cells that can be addressed.
ENm	Enable Dependency—Binary affecting input which, when active enables all outputs. When inactive open-collector and open-emitter outputs are off, and three-state outputs are at an external high impedance state. When the enable input affects only certain inputs and outputs, they will be numbered to indicate the logic connection.
Xm	Transmission Dependency—Binary affecting input which bidirectionally connects dependent inputs and outputs.
Mm	Mode Dependency—Binary affecting input used to indicate that the effects of particular inputs and outputs of an element depend on the mode in which the element is operating. The m is replaced with a number or letter (the identifier).
Zm	Interconnection Dependency—Indicates the existence of internal logic connections between inputs, outputs, internal inputs, and/or internal outputs. The m is replaced with a number (the identifier).
,	Comma—AND Function.
/	Slant—OR Function.

**NOTE**

*The identifier (m) is omitted if it is one—that is, when there is only one dependency relationship of that kind in a particular device. When this is done, the dependency indicator itself (G, C, EN, or V) is used to prefix or suffix the affected (dependent) input or output.*

Table 8-3. Schematic Diagram Notes (8 of 8)

**DIGITAL SYMBOLOGY REFERENCE INFORMATION**

**Miscellaneous**



Schmitt Trigger—Input characterized by hysteresis; one threshold for positive going signals and a second threshold for negative going signals.

Active

Active State—A binary physical or logical state that corresponds to the true state of an input, an output, or a function. The opposite of the inactive state.

# Procedure Guide

## COMMENT

*When looking at the instrument, some of the mechanical procedures may seem intuitively obvious. There are, however, some hidden problems. We strongly recommend that you read through an entire procedure before performing any of the steps in these mechanical procedures.*

Procedure	Paragraph
Introduction .....	8-1
Tools .....	8-2
Open/Close Front Panel (Except Option 002).....	8-7
Open/Close Front Panel (Option 002 Only).....	8-8
Remove/Replace A1 Module .....	8-10
Remove/Replace LCD Display .....	8-11
Replace LCD Lamps .....	8-12
Remove/Replace A2 Module .....	8-9
Remove/Replace Top Cover .....	8-3
Remove/Replace A3 Module .....	8-5
Remove/Replace A4 Module .....	8-6
Remove/Replace A4 Module .....	8-25
Remove/Replace RF Modules (A6, A7, A9, A11-14, A16, A19) .....	8-4
Module Disassembly (A6, A7, A9, A11-14, A16, A19) .....	8-21
Remove Printed Circuit Assemblies .....	8-22
Replace Printed Circuit Assemblies .....	8-23
Remove/Replace Right Side Cover .....	8-13
Remove/Replace A17 Module .....	8-14
Remove/Replace Rear Bottom Cover .....	8-15
Remove/Replace A18 Module .....	8-16
Remove/Replace A20 Module .....	8-17
Remove/Replace Fan (B1).....	8-19
Remove/Replace A5 Ribbon Cables .....	8-20
Remove/Replace Module Feedthrough Filter Network .....	8-24
Remove/Replace A8 Oscillator (Option 001 Only).....	8-18

## 8-1. INTRODUCTION

This section contains mechanical procedures required for service of the HP 8642A/B Synthesized Signal Generator. The instrument should be serviced in an electrostatic discharge protected environment. For your safety, read the warnings and cautions in the General Information section of this manual before performing the assembly/disassembly procedures.

### NOTE

*Unless otherwise noted, the directions "left" and "right" given in the instructions are referenced as though you are looking at the instrument from the front panel.*

The first page of this section, **PROCEDURE GUIDE**, is a quick reference for locating the paragraph in which the removal and replacement procedures for each module/assembly can be found.

## 8-2. TOOLS

Most screws used in instrument are Torxhead screws. They require a torque driver and Torxhead bits for proper removal and installation.

*To avoid damage, do not exceed the following torque limits:*

*Torque limit for 4 mm screws: 2.2 Nm. (Use bit T15)*

*Torque limit for 3 mm screws: 1.5 Nm. (Use bit T10)*

Two bits are located in tool pouch sent with the Operating Manual.

To set torque limit of wrench, remove cover from end of handle. Lift the key to the vertical position and turn clockwise to increase torque setting, or turn counter-clockwise to decrease torque setting. Align hairline on clear bulb of wrench shaft with the desired setting. Push the key back to the flat position (a very slight turn in either direction may be necessary for key to lock into place).

Also included in the tool pouch are two module extender posts.

An RF connector wrench is located above fan on right inner wall of center rear bracket. A fuse extraction/insertion tool is located on top of rear frame under the power supply cover.

The On-Site Service Kit contains many tools needed to service the instrument. (See Table 9-1 for contents of kit.)

Other tools required but not contained in the kit are:

- 2 pt. Pozidrive screwdriver.
- 1 pt. Pozidrive screwdriver
- 6.0 mm open end wrench.
- Small flathead screwdriver.
- Small needlenose pliers
- Small diagonal cutters
- Soldering/Desoldering tools

Tools not included in the kit which are called for in the procedures are printed in italics.

**8-3. TOP COVER**

Removal Time:	2 min
Replacement Time:	2 min
Tools Required:	<i>Pozidrive screwdriver.</i>

**To Remove: Top Cover**

1. Remove four rear feet from rear frame of instrument by removing screw in each foot.
2. Loosen screw in middle of rear edge of top cover. This is a captive screw (attached to top cover). Loosening it will cause cover to push away from front frame.
3. Slide top cover toward rear of instrument to disengage and lift and away. The cover has a tight fit and may need to be worked loose.

**To Replace: Top Cover**

1. Place cover onto top of instrument making sure that the cover fits into the grooves on the top of the side covers. Slide cover toward front of instrument while applying a slight downward pressure to front edge of cover. Guide into slot in top of front frame. The cover has a tight fit and may need to be worked forward.
2. When screw on rear edge of cover is in contact with rear frame tighten it. The cover should move forward as the screw is tightened.
3. Replace four feet on rear frame, one screw in each.

**8-4. RF MODULES: A6, A7, A9, A11-14, A16, A19**

Removal Time:	4 min
Replacement Time:	8 min
Tools Required:	RF connector wrench

To locate module, refer to drawing on inside of instrument top cover.

**To Remove: A6, A7, A9, A11-14, A16, A19**

1. Remove top cover (Refer to paragraph 8-3.)
2. Reroute obstructing coax cables around ends of module. (These are cables lying across the top of module that would hinder lifting of module from the instrument.)
3. Use RF connector wrench provided in the instrument to disconnect intermodular cables from the module being removed. (These are cables which connect the module to other parts of the instrument, including ribbon cables.)
  - To avoid damaging semi-rigid coax cables, disconnect both ends of cable.

**NOTE**

*DO NOT disconnect intramodular cables. (These are cables which connect from one point on the module to another point on the same module.) Intramodular cables must remain in place for proper module calibration.*

4. Slide L-shaped retaining clip at each end of module toward center of module to release from guide post. See figure 1. **RF MODULE MECHANICAL PARTS** on the foldout at the end of this section.
5. Using the finger loops on the retaining clips, lift module from instrument.
6. Loosen the black ribbon cable retaining screw on the module slide three turns. Carefully slide ribbon cable from behind retaining screw.

**To Replace: A6, A7, A9, A11-14, A16, A19**

1. Clear cables from empty module slot.
2. Route ribbon cable behind ribbon cable retaining screw on module slide. Retighten the retaining screw. Pull cable up until bar rests in cable fold. (With a new cable the fold will not be evident. Allow enough slack in the cable to accommodate lowering the module into the instrument.)
3. Align module slide with guide post mounted in instrument. (Modules are designed so slide will not align properly if an attempt is made to install module backwards.)
4. Using finger loops on module slides, lower module into place.
5. Align retaining clips with notch in guide posts and slide clips into notch to lock module in position.
6. Reconnect all cables. Tighten connectors finger tight, then use RF connector wrench to tighten only slightly more (about 1/2 turn: 1 N.m). The RF connectors on the modules are fragile and over-torquing could cause damage. (Refer to inside of instrument top cover for cable connections.)



*Make sure that ribbon cable on top of A12 Module (W5) is dressed under the SMC connector of A12W4 (91). If the ribbon cable is allowed to rest on the top of the connector it may be punctured when the top cover is replaced.*

**To Extend: (A6, A7, A9, A11-14, A16, A19)**

1. Remove top cover (Refer to paragraph 8-3.)
2. Reroute any obstructing cables around ends of module.



3. Screw extender posts into top of module guide posts.
4. Slide L-shaped retaining clip at each end of module toward center of module to release from guide post.
5. Slide Module to top of extender.
6. Align retaining clip with notch in extender post. Slide clip into locked position.

#### 8-5. CONTROL MODULE: A3

Removal Time:	1 min
Replacement Time:	1 min
Tools Required:	None

#### To Remove: A3

1. Remove top cover. (Refer to paragraph 8-3.)
2. Disconnect the yellow cable fastener from mounting hole on the A11 module.
3. Raise the black extractor and the white extractor to upright position. The extractors may be difficult to raise. You will feel resistance from the connectors on the bottom of the module as you raise them.
4. Grasp the extractors in the upright position and pull module up, out of instrument.

#### To Replace: A3

1. Raise the black extractor and the white extractor to upright position.
2. Position module so extractor colors match colors of plastic guides in instrument (component side toward front of instrument).
3. Align board edges with the left and right slots in plastic guides.
4. Push board into instrument holding extractors in upright position.
  - Be sure yellow power meter cable isn't caught between the modules.

5. Push extractors down to lock module into notch near top of guides.
6. Push the yellow cable fastener into mounting hole on the A11 module.

#### **8-6. CONTROL MODULE: A4**

Removal Time:	1 min
Replacement Time:	4 min
Tools Required:	None

#### **To Remove: A4**

1. Remove top cover. (Refer to paragraph 8-3.)
2. Raise the black and the white extractors to upright position. The extractors may be slightly difficult to raise. You will feel some resistance from the connectors on the bottom of the module as you raise them.
3. Grasp the extractors and pull module up, out of instrument.

#### **To Replace: A4**

1. Check that ribbon cable shields are in place between ribbon cables on A5 module and A4 slot. Check that ribbon cables and shields are not obstructing connectors into which A4 plugs.
2. Raise the black and the white extractor to the upright position.
3. Position module so extractor colors match colors of plastic guides mounted in instrument (component side toward rear of instrument).
4. Align board edges with the left and right slots in plastic guides.
5. Push board into instrument holding extractors in upright position. As you lower A4 module into instrument, check that ribbon cables on A5 module stay in place.
6. Push extractors down to lock module into notch near top of guide.

**8-7. FRONT PANEL**  
(Except Option 002)

Opening Time:	5 min
Closing Time:	4 min
Tools Required:	Torque driver, Torxhead bits, <i>small flathead screwdriver</i>

Front panel assembly is mounted into front frame on a hinge. Hinge mechanism is located on left side of front panel and allows right side to swing open like a door for accessing A1 and A2 Modules. If your instrument is an Option 002, go to paragraph 8-8.

**COMMENT**

*This procedure requires careful attention to each step. Read through the entire procedure before performing any of the steps. If you don't follow the instructions, it's the pits.*

**To Open: Front Panel**

1. Remove any adapters from RF Output connector.
2. Insert a screwdriver into holes in slot in rear edge of top plastic trim strip, and gently pry strip from top of front frame.
3. On top of front frame, remove two countersunk screws (first and thirteenth holes, counting from the right).

On the bottom of front frame, remove three countersunk screws (third, eighth, and twelfth holes, counting from right).

4. Grasp AM/Pulse Input Connector (J1) and Mod Output Connector (J3). Pull outward until entire front panel clears front frame by about 1/2 inch. If it is difficult to pull front panel out, it may be helpful to slightly loosen two screws on bottom of front frame under RF OUTPUT connector (CP1).



*DO NOT swing right side open until entire panel is pulled out from front frame. Left (hinged) side of front panel may be damaged if not pulled out from frame before right side is swung open.*

5. Slowly swing right side of panel outward while carefully guiding left side of front panel away from left edge of frame. (In other words, don't crunch the left side of the pretty fiberglass front panel into the left side of the frame or you'll ruin it.)

**To Close: Front Panel**

1. Using J1 (AM/PULSE INPUT connector) to guide left side of the front panel, slowly swing right side of panel inward until "door" is almost closed (remember don't crunch it).
2. Push left side of panel into front frame, then push right side into frame.
3. Replace screws in first and thirteenth countersunk holes in top of front frame and replace screws in third, eighth and twelfth holes in bottom of front frame (count from right).
4. Tighten two screws under RF OUTPUT connector if they were loosened when front panel was opened (refer to paragraph 8-8, step 4).
5. Press top plastic trim strip into place on top of front frame, slot toward rear of instrument.

**8-8. FRONT PANEL  
(Option 002 Only)**

Opening Time:	5 min
Closing Time:	4 min
Tools Required:	Torque driver, Torxhead bits, <i>small flathead screwdriver</i>

Front panel assembly is mounted into front frame on a hinge. Hinge mechanism is located on left side of front panel and allows right side to swing open like a door for accessing A1 and A2 Modules. If your instrument is not an Option 002, go to paragraph 8-7.

**COMMENT**

*This procedure requires careful attention to each step. Read through the entire procedure before performing any of the steps. If you don't follow the instructions, it's the pits.*

**To Open: Front Panel**

1. Insert a screwdriver into the holes in slot in rear edge of top plastic trim strip, and gently pry strip from top of front frame.
2. On top of front frame, remove two countersunk screws (first and thirteenth holes, counting from right).

On bottom of front frame, remove three countersunk screws (third, eighth and twelfth holes, counting from right).

3. Grasp round knob on front panel and pull panel outward about 1/2 inch. If left side of panel is stuck in frame, use a screwdriver to gently pry it out of frame.



*DO NOT swing right side open until entire panel is pulled out from front frame. Left (hinged) side of front panel may be damaged if not pulled out from frame before right side is swung open.*

4. Slowly swing right side of panel outward while carefully guiding left side of front panel away from left edge of frame. (In other words, don't crunch the left side of the pretty fiberglass front panel into the left side of the frame or you'll ruin it.)

**To Close: Front Panel**

1. Hold left side of panel out from front frame while swinging right side inward until "door" is almost closed (remember, don't crunch it).
2. Push left side of panel into front frame, then right side.
3. Replace screws in first and thirteenth countersunk holes counting from the right, in top of front frame.
4. Press top plastic trim strip into place on top of front frame, slot toward rear of instrument.

**8-9. RF MODULE: A2**

Removal Time:	10 min
Replacement Time:	15 min
Tools Required:	Torque driver, Torxhead bits, RF connector wrench, <i>diagonal cutters</i> , cable ties.

Front panel assembly is mounted into front frame on a hinge. Hinge mechanism is located on left side of front panel and allows right side to swing open for accessing A1 and A2 Modules. A1 is mounted onto the hinged "door" that swings open. A2 is mounted in the front frame of the instrument.

**To Remove: A2**

1. Open front panel. (Refer to paragraph 8-7: Standard; paragraph 8-9: Option 002.)
2. Disconnect coax cables using RF connector wrench.
  - Clip cable ties holding cable bundle to module ties. (See figure 4. A2 Cable Ties and Connectors on foldout at the end of this section.)
3. Remove seven screws securing module to instrument.
4. Disconnect ribbon cable from A2J1, then pull the module out of instrument.

**To Replace: A2**

1. Slip four cable ties under ties on component side of module.
2. Position module with component side toward front. Connect ribbon cable at A2J1.
3. Secure module to metal shield. (7 screws, finger tight).
  - When all screws are in place tighten each one.
4. Connect coax cables. See instrument top cover for cable connections. Use cable ties installed in step 1 to secure cables to module.
5. Close front panel. (Refer to paragraph 8-7: Standard; paragraph 8-8: Option 002.)

**8-10. CONTROL MODULE: A1**

Removal Time:	8 min
Replacement Time:	8 min
Tools Required:	Torque driver, Torxhead bits, 6 mm open end wrench.

Front panel assembly is mounted into front frame on a hinge. Hinge mechanism is located on left side of front panel and allows right side to swing open for accessing A1 and A2 Modules. A1 is mounted onto the hinged "door" that swings open. A2 is mounted in the front frame of the instrument.

A1 module consists of A1A1 Keyboard Assembly and A1A2 LCD Display Assembly. References to A1 refer to the module as a single unit.



*When removing A1 Module, the A1A2 LCD Display Assembly can be inadvertently detached from the keyboard. Remove A1 slowly and be sure that the display is firmly in place. It is advisable to wear gloves when handling the LCD display, it is easily soiled and not so easily cleaned.*

*The A1A2 LCD Display Assembly is extremely static sensitive. Observe handling precautions described in Section I of this Manual.*

**To Remove: A1**

1. Open front panel. (Refer to paragraph 8-7: Standard; paragraph 8-8: Option 002.)
2. Remove four screws securing metal shield to back of A1 module. Pull shield off.
3. Remove ten hex nuts securing module to front panel standoffs.



*To avoid damage to key caps, and to avoid pulling switches loose, pull A1 rearward slowly, keeping key caps aligned with holes in front panel.*

4. Pull module away from front panel far enough to disconnect RPG (knob) wiring harness from A1A1J3. RPG, Rotary Pulse Generator, is round, black assembly attached to front panel visible through cutout in A1A1 assembly.
5. Disconnect the ribbon cable from A1A1J1.
6. Pull module from instrument.

**To Replace: A1**

1. Position board with component side toward front panel.
2. Connect ribbon cable at A1A1J1.
3. Route RPG (knob) wiring harness through circular hole in A1 Module then back under A1 module to front. Connect at A1A1J3.
4. Align keys with holes in front panel, and mounting holes with standoffs, then push board into place onto standoffs.
5. Place hex nut onto each standoff (qty 10) and tighten finger tight. When each nut is in place tighten each one.
6. Position metal shield with U-shaped cutout over RPG (knob) assembly.
7. Secure shield to front panel with four screws.
8. Close front panel (refer to paragraph 8-7: Standard; paragraph 8-8: Option 002.)



**8-11. LCD DISPLAY ASSEMBLY A1A2**

Removal Time:	2 min
Replacement Time:	2 min
Tools Required:	None



*When removing A1 Module, the A1A2 LCD Display can be inadvertently detached from keyboard. Remove A1 slowly and check that the display is firmly in place. It is advisable to wear gloves when handling the LCD display, it is easily soiled and not so easily cleaned.*

*The A1A2 LCD Display Assembly is extremely static sensitive. Observe handling precautions described in Section I or Section VII general information of this manual.*

**To Remove: A1A2**

1. Open front panel. (Refer to paragraph 8-7: Standard; paragraph 8-8: Option 002.)
2. Remove A1 module. (Refer to paragraph 8-10.)
3. Lay A1 Module flat, component side up.
  - A1A2 assembly plugs into A1 module at A1A1J4 and A1A1J5.
  - Grasp connectors on A1A2 Assembly and pull both upward at the same time. There will be resistance as you pull, DO NOT use a twisting action as you pull upward, this may cause damage to components or solder connections.

**To Replace: A1A2**

1. Carefully align plugs A1A2P1 and A1A2P2 with connector pins of A1A1J4 and A1A1J5.
  - With even pressure at both ends, press display into place.
2. Replace A1 module (refer to paragraph 8-10).

**8-12. LCD DISPLAY INCANDESCENT LAMPS**

Replacement Time:	10 min
Tools Required:	Torque driver, Torxhead bits, <i>Soldering iron, desoldering tool, needlenose pliers, gloves.</i>

**CAUTION**

*When removing A1 Module, the A1A2 LCD Display Assembly can be inadvertently detached from the keyboard. Remove A1 slowly and be sure that the display is firmly in place. It is advisable to wear gloves when handling the LCD display, it is easily soiled and not so easily cleaned.*

*The A1A2 LCD Display Assembly is extremely sensitive. Observe handling precautions described in this Manual.*

**To Replace: Incandescent Lamp**

1. Remove A1A2. (Refer to paragraph 8-7 Standard; paragraph 8-8 Option 002.)
2. On end of display on which defective lamp is located, remove two screws securing black end cap of LCD display. The screw on the upper edge of the end cap requires two washers, don't lose them. Remove end cap.
3. Unsolder two leads of incandescent lamp, and remove lamp from mounting holes. To avoid damage to printed circuit traces and plated mounting holes, be sure leads are completely unsoldered before pulling lamp free.
4. Form leads of new lamp to fit spacing of mounting holes. Place leads in mounting holes and solder lamp into place.
5. Replace black end cap over lamp, and secure from circuit side with two screws. Screw on upper edge of end cap requires two washers.
6. Replace A1A2 Assembly. (Refer to paragraph

**8-13. RIGHT SIDE COVER**

Removal Time:	2 min
Replacement Time:	2 min
Tools Required:	<i>Pozidrive screwdriver.</i>

**To Remove: Right Side Cover**

1. Remove the four feet on rear frame by removing screw in each foot.
2. Remove top cover. (Refer to paragraph 8-3.)
3. Loosen screw on rear edge of right cover. This is a captive screw (attached to cover), loosening it will cause cover to push back away from front frame.
4. Being careful not to dislodge foam pieces on cover, pull side cover from chassis after screw is disengaged from frame.

**To Replace: Right Side Cover**

1. Inspect side cover for loose or damaged foam. Replace if necessary. Foam is critical to proper air flow in the instrument.
2. Place groove on bottom edge of side cover onto edge of bottom cover.
3. Slide cover from rear frontward until captive screw on rear edge of side cover is in contact with rear frame. The screw should be in position to be tightened into frame. Cover will move forward into place as the screw is tightened.
4. Replace top cover. (Refer to paragraph 8-3.)
5. Replace four feet on rear frame.

**8-14. POWER SUPPLY MODULE: A17**

Removal Time:	10 min
Replacement Time:	12 min
Tools Required:	Torque driver and Torxhead bits.

**WARNING**

*Left rear portion of the instrument becomes hot during operation; a cooling period may be desired before servicing.*

*To avoid personal injury, avoid contact with the A17 heatsink when the A17 Module is extended.*

**To Remove: A17**

1. Remove power to instrument.
2. Remove top cover (Refer to paragraph 8-3.)
3. Remove right side cover. (Refer to paragraph 8-13.)
4. Remove power supply cover (one screw).
5. Remove 13 screws on side frame indicated in figure 2. **A17 MODULE MECHANICAL PARTS** on the foldout at the end of this section.
6. Lift module partially out of instrument to expose ribbon cable connectors through gap in side frame. Push levers on ribbon cable connectors apart to release ribbon cables.
7. Disconnect power supply wiring harness (W13) from A17 connector below heatsink.
8. Lift module out of instrument.

**COMMENT**

*You may feel resistance as you pull the board upward. This is caused by one of the foam strips adhered to the circuit side of the board. Use slow but firm upward pressure.*

**To Replace: A17**

1. Position component side of board toward outside of instrument.
2. Connect power supply wiring harness (W13) to A17 connector below heatsink.
3. Lower board into place.

**COMMENT**

*You may feel resistance as you lower the board into place. This is caused by one of the foam strips adhered to the circuit side of the board. Use slow but firm downward pressure.*

4. Connect ribbon cable 08642-60013 to A17J3, and 08642-60012 to A17J2. (Ribbon cable part numbers are stamped on the cable.)
5. Foam strip should overlap metal bracket to seal gap between bracket and A17.
6. Align module with screw holes. Replace 13 screws finger tight. When all the screws are in place, tighten each one. (Refer to figure 2. **A17 MODULE MECHANICAL PARTS** on the foldout at the end of this section.)
7. Replace side cover. (Refer to paragraph 8-13.)

**To Extend: A17**

1. Remove power to instrument.
2. Remove top cover (refer to paragraph 8-3).
3. Remove power supply cover (one screw).
4. Remove screws shown in 2. **A17 MODULE MECHANICAL PARTS** on the foldout at the end of this section.
5. Lift module partially out of instrument to expose ribbon cable connectors through gap in side frame. Push levers on ribbon cable connectors apart to release ribbon cables.
6. Pull module up until lower mounting holes on module are aligned with top row of holes in upper rail of frame.
7. Insert screws through holes in top rail into bottom mounting holes on A17 and tighten finger tight. When all screws are in place, tighten each one.

8. Connect ribbon cable 08642-60013 to A17J3, and 08642-60012 to A17J2. (Ribbon cable part numbers are stamped on the cable.)
  - Be sure the power supply wiring harness remains connected.
9. Reconnect power.

### 8-15. REAR BOTTOM COVER

Removal Time:	5 min
Replacement Time:	3 min
Tools Required:	<i>Posidrive screwdriver, small flat head screwdriver, patience.</i>

To access the A18 Module or Option 001 A8 Assembly, only the REAR bottom cover should be removed. All other modules are accessible through the top of the instrument.



*Do not remove center bottom cover, it is important to the structural stability of instrument. Any serviceable parts in the center section of instrument are accessible through top of the instrument.*

*Remove line power cord before removing this cover.*

#### To Remove: Rear Bottom Cover

1. Remove the four feet on the rear frame by removing screw in each foot.
2. Turn instrument on its side and remove the two rear feet on bottom cover.
3. Unscrew four screws on front edge of cover.
4. Slide cover toward rear of instrument and lift cover from instrument. Cover fits snugly and may need to be worked loose. don't give up.

#### To Replace: Rear Bottom Cover



*Remove line power cord before replacing rear bottom cover.*

1. Slide rear bottom cover from rear forward and align holes in front edge with holes rear edge of center bottom cover.
2. Insert and tighten four screws.
3. Replace two rear feet on bottom of instrument.
4. Replace four feet on rear frame.

#### 8-16. POWER SUPPLY MODULE: A18

Removal Time:	10 min
Replacement Time:	10 min
Tools Required:	Torque driver and Torxhead bits, <i>insulated screwdriver</i> .

#### WARNING

*Do not operate the instrument with the A18 Module extended. The screws securing the A18 Power Supply Rectifier and Filter Module to the chassis are an integral part of the protective grounding of the instrument.*

*The left rear portion of the instrument becomes heated during operation and a cooling period may be desired before servicing.*

*Capacitors inside the instrument may still be charged even if the instrument has been disconnected from its source of supply.*

#### To Remove: A18

1. Remove power to instrument.
2. Remove top cover. (Refer to paragraph 8-3.)
3. Remove power supply cover (one screw).
4. Remove bottom rear cover (refer to paragraph 8-15.)
5. Using insulated screwdriver, discharge capacitors by shorting mounting screws together.
6. Remove screws on bottom of A18 module shown in figure 4. **A18 MODULE MOUNTING SCREWS** on the foldout at the end of this section.

7. Gently push module from top of instrument, while guiding module out from bottom until wires are extended.
8. Disconnect transformer output cable at A18J1. Disconnect cable to fan at A18J2. Disconnect wiring harness to A17 at A18J3.
  - If instrument is Option 001, disconnect wiring harness at A18J4.

**To Replace: A18**

1. Connect cables removed in paragraph 8-16, step 8.
2. Guide module into position from the top of the instrument, and hold in place. Be sure air seal foam and rubber strips are inside instrument (should not overlap on outside). Foam and rubber strips are easily torn and can cause difficulty when positioning the module. It may be necessary to re-position the modules several times before a proper seal is accomplished.
3. Align board with screw holes and secure screws finger tight. Use star washers on all screws. When all screws are in place tighten each one. (See figure 4. **A18 MODULE MOUNTING SCREWS** on the foldout at the end of this section.)
4. Replace bottom cover (refer to paragraph 8-15).
5. Replace power supply cover, one screw.

**8-17. CALIBRATION MODULE A20**

Removal Time:	3 min
Replacement Time:	3 min
Tools Required:	<i>Small flathead screwdriver.</i>

**To Remove: A20**

1. Pull four plastic fastener plungers outward and remove Calibration Module cover. It is not necessary to pull the fasteners completely out of the mounting holes in the cover. (See figure 3. **A20 and B1 MECHANICAL PARTS** on the foldout at the end of this section.)



2. Four plastic fasteners hold Calibration Module to fan access cover on rear panel. Turn screw heads 1/4 turn (fastener shoulders will close).
3. Pull Calibration Module off of fasteners. Fasteners will stay in place on access cover.

**To Replace: A20**

1. Check that the 1/4 turn fasteners on the fan access cover are in the unlocked (shoulders closed) position. Push Calibration Module onto fasteners. (See figure 3. **A20 and B1 MECHANICAL PARTS** on the foldout at the end of this section.)
2. Turn fasteners 1/4 turn (shoulders open) to secure Calibration Module to access cover.
3. Align plastic fasteners on Calibration Module cover with mounting holes in rear panel.
  - Push the fastener socket into the mounting hole. Then push the fastener plunger in.

**8-18. A8 OSCILLATOR MODULE (OPTION 001)**

Removal Time:	12 min
Replacement Time:	10 min
Tools Required:	Torque driver and Torxhead bits.

**To Remove: A8**

1. Remove top cover. (Refer to paragraph 8-3.)
2. Remove rear bottom cover. (Refer to paragraph 8-15.)
3. From bottom of instrument, disconnect wiring harness from A18J4.
  - Disconnect coax cable from A8J1.
4. From top of instrument, remove modules A7 and A9. (Refer to paragraph 8-4.)
5. Remove four screws on top of A8 securing it to metal bracket.
6. Pull A8 toward front panel, then out of instrument. A8 has a tight fit between bottom cover and metal bracket. Use a slight downward pressure on the A8 Assembly to ease the removal process.

**To Replace: A8**

1. Position A8 module with screw holes up and wiring harness toward rear of instrument.
2. Push A8 under metal bracket with slight downward pressure, while guiding the wiring harness through the rectangular hole in the rear of the bracket.
3. Align screw holes with holes in metal frame.
4. Secure with four screws.
5. From bottom of instrument, reconnect wiring harness to A18J4. Be sure all connector pins on A18J4 are properly plugged into in wiring harness connector.
  - Reconnect coax cable to A8.
6. Replace rear bottom cover. (Refer to paragraph 8-15.)
7. From top of instrument, replace A7 and A9 modules. (Refer to paragraph 8-4).
8. Replace top cover. (Refer to paragraph 8-3.)

**8-19. FAN (B1)**

Removal Time:	6 min
Replacement Time:	8 min
Tools Required:	Torque driver, torxhead bits

**To Remove: B1**

1. Remove calibration board cover by pulling plastic fastener plungers outward. (See figure 3. **A20 and B1 MECHANICAL PARTS** on the foldout at the end of this section.)
2. Remove four screws in access cover securing it to rear panel.
3. Fan is mounted to access cover. Pull access cover and attached fan out of instrument.
4. Disconnect wire connector at A18J3.
5. Remove 2 screws that attach fan to rear fan mounting bracket on access cover (one in upper right corner, one in lower left corner).

**To Replace: B1**

1. Mount fan to rear fan mounting bracket on fan access cover with 2 screws as shown in figure 3. Air directional arrows point down and to right. (See figure 3. **A20 and B1 MECHANICAL PARTS** on the foldout at the end of this section.
2. Route wire through rear panel to connector A18J3. Black (or blue) wire toward large blue capacitors on A18 module.
3. Push fan into access hole in the rear panel. The wire to A18J3 should be routed into the corner of the front sheet metal support bracket with any excess wire looping up. As you push the fan into place, make sure that the wire does not get disconnected.
4. Replace screws securing access cover to rear panel.
5. Replace Cal Board Cover. (Refer to paragraph 8-17 **To Replace: A20** step 3.)

**8-20. A5 RIBBON CABLES (W1-W8, W11, W14, W15)**

Removal Time: 3 min per cable  
Replacement Time: 5 min per cable  
Tools Required: Torque driver, torxhead bits, *small flathead screwdriver*.

**To Disconnect: W1-8, W11**

1. Remove A4. (Refer to paragraph 8-6)
  - Some of the ribbon cables are protected by the ribbon cable shields. Flip the plastic ribbon cable shield up to expose the ribbon cable connectors under it.
  - The shield is pliable, and can be bowed slightly when raising it.
2. Cable connectors A5J1-8 (upper row of connectors) are positioned so their pins point downward.
  - Push the cable plug downward to free the cable from the connector on A5.

**To Reconnect: W1-W8, W11**

1. Remove A4. (Refer to paragraph 8-6)
2. Fold the cable over the top of A5 and curl it under its A5 connector to align the plug with connector pins.
3. Push the plug upward onto the connector.
4. Replace the ribbon cable shields (if necessary).

**To Remove: W1-W8, W11**

1. Repeat **To Disconnect: W1-8, 11** steps 1-2.
2. Clip cable ties securing retaining bar to A5 Module.
3. Extend module to which cable attaches. (Refer to paragraph 8-4.)
4. On the module slide, loosen the black ribbon cable retaining screw three turns. Slide the cable from behind the retaining screw. (See figure 1. **RF MODULE MECHANICAL PARTS** on the foldout at the end of this section.)
5. Pull cable from module connector.

**To Replace: W1-8, W11**

1. Extend module to which cable attaches. (Refer to paragraph 8-4.)
2. Plug cable into module connector by matching the arrow on the cable connector with the arrow on the module connector.
3. Slide the cable behind the ribbon cable retaining screw on the module slide and retighten the screw. (See figure 1. **RF MODULE MECHANICAL PARTS** on the foldout at the end of this section.)
4. Remove A4. (Refer to paragraph 8-6)
5. Curl the cable over the top of A5 and under its A5 connector to align the plug with connector pins.
6. Push the plug upward onto the A5 connector.

7. Lower module into instrument.
8. Tie wrap the retaining bar to the A5 Module to hold all ribbon cables in place.
9. Replace A4 (refer to paragraph 8-6).

**To Disconnect: W14, W15**

W15 is split between connectors A5J9 and A5J10. W14 is connected to A5J11.

1. Remove A3 and A4. Refer to paragraphs 8-5 and 8-6.)
2. Flip the plastic ribbon cable shield up to expose the ribbon cable connectors under it.
  - The shield is pliable, and can be bowed slightly when raising it.
3. Insert a flat head screwdriver between the plastic retaining clip and the connector body and gently pry clip from A5 connector and cable plug.
4. Pull cable from connector.

**To Reconnect: W14, W15**

1. Align cable plug with A5 connector and push plug onto connector pins.
2. Insert the notched edge of the retaining clip into the slot on the A5 connector, push the smooth edge of the clip over the end of the cable plug.
3. Replace the ribbon cable shield.

**To Remove: W14, W15**

These cables can be removed by following the steps outlined for removing A5 Module (paragraph 8-25).

**To Replace: W14, W15**

These cables can be replaced by following the steps outlined for replacing A5 Module (paragraph 8-25).

**8-21. MODULE DISASSEMBLY: A6, A7, A9, A11-14, A16, A19**

Dissassembly:	Conditional
Assembly:	Conditional
Tools Required:	Conditional

Modules in the center section of the instrument are similar in construction. Printed Circuit (PC) board assemblies are mounted in metal castings to isolate RF circuits from each other and from the outside.

The PC boards are mounted to a casting called the base. The base is generally the center piece of the module. One, two or three boards are mounted to the base. Connections between boards on opposite sides of the base are accomplished with cabling or with feedthrough filters.

The feedthrough filters are mounted to one side of the base. They can be singular filters or they can be arranged in an array. The PC boards have connectors which fit over the filter pins.

The outer castings are called covers and are named after the circuitry on the PC board(s) over which they mount. For example PC Board Assembly, A13A1 is the Low Pass Filter Assembly; the cover mounted over A13A1 is, A13MP1 COVER LOW PASS FILTER.

Module Slides are attached to the end of the module to mount the module to the instrument and to facilitate the removal, replacement or extension of the module.

**8-22. PRINTED CIRCUIT (PC) BOARDS: REMOVAL**

Removal Time:	Conditional
Tools Required:	Conditional

The following procedure is a generic **removal** procedure. Modifications peculiar to an assembly are listed following the generic procedure. *Table 8B-1. Removal Modifications* lists which steps, if any, are modified or added for a particular module. Substitute the **MODIFICATIONS** into the generic procedure as directed.

Table 8B-1. Removal Modifications

ASSEMBLY NUMBER	NO CHANGES	ADD STEP	REPLACE STEP	OMIT STEP
A6A1	X			
A6A2	X			
A7A1			4, 5	
A9A1	X			
A9A2	X			
A11A1	X			
A11A2	X			
A11A3	X			
A12A1	X			
A12A2	X			
A12A3	X			
A13A1		1A		
A13A2	X			
A14U1			1, 2	3-7
A14A2		1A		
A14A3		1A		
A16A1	X			
A16A2	X			
A16AT1, 2			1, 2	3-7
A19A1	X			
A19A2	X			
A19A3	X			
A19AT1, 2			1, 3	4-7
A19K1, 2			1, 3	4-7

**To Remove: Generic**

1. Remove module from instrument. (Refer to paragraph 8-4.)
2. Remove screws in casting cover on side of module board assembly is located (see diagram on inside of instrument's top cover to locate board assembly); lift cover off of module.
3. Disconnect all interboard cables (cables that go from one board or assembly to another) from the board being removed.



*PC Board is secured to base by mounting screws and feedthrough filters. Feedthrough filter pins fit snugly into connector on board. Filters may be damaged if board is not lifted straight up off of the pins. There will be some resistance as you pull the board upward.*

4. Remove screws securing board to module base.
5. Carefully lift board straight up from base until clear of filter pins.

**A6A1 MODIFICATIONS: 08642-60101**

None

**A6A2 MODIFICATIONS: 08642-60102**

None

**A7A1 MODIFICATIONS: 08642-60103**

**To Remove:**

4. Remove screws securing board to base.
5. Lift board from base.

**A9A1 MODIFICATIONS: 08642-60104**

None



**A9A2 MODIFICATIONS: 08642-60105**

None

**A11A1 MODIFICATIONS: 08642-60106**

None

**A11A2 MODIFICATIONS: 08642-60107**

None

**A11A3 MODIFICATIONS: 08642-60108**

None

**A12A1 MODIFICATIONS: 08642-60109**

None

**A12A3 MODIFICATIONS: 08642-60110**

None

**A12A3 MODIFICATIONS: 08642-60111**

None

**A13A1 MODIFICATIONS: 08642-60112**

**To Remove:**

- 1A. Use large flathead screwdriver to remove round transistor heatsink from the casting cover. Heat sink is screwed onto shaft of transistor mounted on A13A1.

**A14 MODIFICATIONS: HET SWITCH (A14U1)****To Remove: A14U1**

1. Remove A14 Module (refer to paragraph 8-4).
2. Remove cables from top of A14U1. To avoid damage to semi-rigid cables disconnect them at both ends.
3. Unplug wiring harness from A14A3J5.
4. Remove two screws securing HET switch to base.

**A14A2 MODIFICATIONS: 08642-60115****To Remove:**

- 1A. Use large flathead screwdriver to remove round transistor heatsink from the casting cover. Heat sink is screwed onto shaft of transistor mounted on A13A1.

**A14A3 MODIFICATIONS: 08642-60116****To Remove:**

- 1A. Use large flathead screwdriver to remove round transistor heatsink from the casting cover. Heat sink is screwed onto shaft of transistor mounted on A13A1.

**A16A1 MODIFICATIONS: 08642-60145 (Option 003 only)**

None

**A16A2 MODIFICATIONS: 08642-60119 (Option 003 only)**

1. Remove semi-rigid cable from attenuators. To avoid damaging the cable, be sure to disconnect both ends.  
  
Disconnect ribbon cables.
2. Remove mounting screws (two per attenuator) on the opposite side of the base.

**A19A1 MODIFICATIONS: 08642-60118**

None

**A19A2 MODIFICATIONS: 08642-60119**

None

**A19A3 MODIFICATIONS: 08642-60120**

None

**A19 ATTENUATORS: A19AT1 and A19AT2****To Remove:**

1. Remove A19A1.
2. Remove mounting screws (four per attenuator) on the side of the base from which the A19A1 Assembly was removed.
3. Remove semi-rigid cable from attenuators. To avoid damaging the cable, be sure to disconnect both ends.

Disconnect ribbon cables.

**A19 SWITCHES: A19K1 and A19K2****To Remove:**

1. Remove semi-rigid cables from tops of switches.
2. Remove mounting screws (2 per).
3. Disconnect ribbon cable.

**8-23. PRINTED CIRCUIT (PC) BOARDS: REPLACEMENT**

Replacement Time:	Conditional
Tools Required:	Conditional

The following procedure is a generic assembly procedure. Modifications peculiar to an assembly are listed following the generic procedure. Table 8B-2 lists which steps, are modified or added for a particular module. Substitute the **MODIFICATIONS** into the generic procedure as directed.

Table 8B-2. Replacement Modifications

ASSEMBLY NUMBER	NO CHANGES	ADD STEP	REPLACE STEP	OMIT STEP
A6A1			4	
A6A2		2A, 2B, 2C	4	6
A7A1			2, 3	
A9A1		2A, 2B, 2C	4	
A9A2		2A, 5A	4, 7	6
A11A1		2A, 2B, 2C, 2D, 7A	4	
A11A2		7A, 7B	4, 6	
A11A3		2A, 7A, 7B	4, 6	
A12A1		7A, 7B	4	
A12A2		7A, 7B	4	
A12A3		2A, 2B, 2C, 2D, 7A	4	
A13A1		8	4, 6, 7	
A13A2		2A, 2B, 2C	4	
A14U1			1-3	4-7
A14A2		2A, 2B, 2C, 8	4, 6, 7	
A14A3		8, 9	4, 6, 7	
A16A1			4	
A16A2			4	6
A16AT1, 2			1-3	4-7
A19A1			4	6
A19A2			4	6
A19A3		2A, 2B, 2C	4	6
A19AT1, 2			1-4	5-7
A19K1, 2			1-4	5-7

**To Replace: Generic**

1. Inspect module base for damaged or missing spira shield gasket. If shield is missing or in poor condition (flattened, unwound, or loose), replace it.
2. Inspect PC Board. Clip long leads on circuit side of board that could cause a short circuit to casting. Lower components whose height would prevent proper placement of the module cover.



*Feedthrough filter bodies are fragile. Use care when pressing board connector onto filter pins.*

3. Position PC Board filter network connector over filter pins and press board into base. Replace mounting screws finger tight, when all screws are in place, tighten each one.
4. Replace all cables. (Refer to MODIFICATIONS for specific cable connections.)
5. Inspect condition of spira shield gasket on module cover; replace if necessary. Replace missing or damaged RF connector or filter gaskets (elastomer).
  - Flat side of RF connector gasket should be flush against board.
6. Check that conductive foam is in place on module cover. If it is missing or damaged replace it.
7. Place cover over PC Board. Replace all screws finger tight, then tighten screws starting in the center and working outward.

**A6A1 MODIFICATIONS: 08642-60101****To Replace:**

4. Reconnect cables as follows:
 

A6A1W1	A6A2J4 to A6A1J3 (94)
--------	-----------------------

**A6A2 MODIFICATIONS: 08642-60102****To Replace:**

- 2A. Check feedthrough filter network for cracked bodies or bent pins. If the filter network is damaged replace it. (Refer to paragraph 8-24.)
- 2B. Check that gasket is in place under the feedthrough filter network. If it is damaged or missing, replace it.

- 2C. Check that Feedthrough filter network is secured to base.
4. Reconnect cables as follows:
- |        |                  |      |
|--------|------------------|------|
| A6A1W1 | A6A2J4 to A6A1J3 | (94) |
|--------|------------------|------|
6. Omit this step.

**A7A1 MODIFICATIONS: 08642-60103**

**To Replace:**

2. Follow directions in step 2, but "CAUTION" does not apply to A7A1.
3. Replace mounting screws finger tight. When all screws are in place tighten each one.

**A9A1 MODIFICATIONS: 08642-60104**

**To Replace:**

- 2A. Check feedthrough filter network for cracked bodies or bent pins. If the filter network is damaged replace it. (Refer to paragraph 8-24.)
- 2B. Check that gasket is in place under the feedthrough filter network. If it is damaged or missing, replace it.
- 2C. Check that Feedthrough filter network is secured to base.
4. Reconnect cables as follows:
- |      |                  |       |
|------|------------------|-------|
| A9W1 | A9A1J1 to A9A2J4 | (947) |
| A9W2 | A9A1J3 to A9A2J2 | (934) |

**A9A2 MODIFICATIONS: 08642-60105**

**To Replace:**

- 2A. Check that foam piece is under **A9A2U20**. This foam should raise the IC so that it will contact the casting cover for heat sinking purposes. If the foam is damaged or missing, replace it.
4. Reconnect cables as follows:
- |      |                  |       |
|------|------------------|-------|
| A9W1 | A9A1J1 to A9A2J4 | (947) |
| A9W2 | A9A1J3 to A9A2J2 | (934) |
- 5A. Apply thermal compound to casting cover where it will come in contact with **A9A2U20**.
6. Omit this step.

7. Place cover over PC Board. Replace all screws finger tight, then tighten screws starting in the corners and working inward.

**A11A1 MODIFICATIONS: 08642-60106**

**To Replace:**

- 2A. Check feedthrough filter network for cracked bodies or bent pins. If the filter network is damaged replace it. (Refer to paragraph 8-24.)
- 2B. Check that gasket is in place under the feedthrough filter network. If it is damaged or missing, replace it.
- 2C. Check that Feedthrough filter network is secured to base.
- 2D. Check that teflon washers are in place on top of feed through filters FL2 and FL3 (single filters). If either or both are missing, replace them. These washers prevent feedthroughs from shorting to A11A1.
4. Reconnect cables as follows:
 

A11W1	A11A1J2 to A11A3J3 (925)
A11W2	A11A1J4 to A11A2J1 (923)
- 7A. Make sure small access cover is secured to casting cover.

**A11A2 MODIFICATIONS: 08642-60107**

**To Replace:**

4. Reconnect cables as follows:
 

A11W2	A11A1J4 to A11A2J1 (923)
A11W3	A11A2J3 to A11A3J6 (SR)
6. Check that polyiron strips and sheets are in place on cover. If they are damaged or missing, replace them. **Whenever the polyiron is replaced, the module must be recalibrated.**
- 7A. Make sure small access cover is secured to casting cover.
- 7B. Check that screws are mounted in the cover in holes marked "C1" and "C15". If either or both are missing, replace them.

**A11A3 MODIFICATIONS: 08642-60108****To Replace:**

- 2A. Place the foam piece onto the areas indicated on the base. The piece is not adhered to the base but is held in place by the board and its mounting hardware.
4. Reconnect cables as follows:
- |       |                          |
|-------|--------------------------|
| A11W1 | A11A1J2 to A11A3J3 (925) |
| A11W3 | A11A2J3 to A11A3J6 (SR)  |
6. Check that polyiron strips and sheets are in place on cover. If they are damaged or missing, replace them. **Whenever the polyiron is replaced, the module must be recalibrated.**
- 7A. Make sure mixer access covers secured to casting cover.
- 7B. Check that screws are mounted in the cover in holes marked "C1" and "C15". If either or both are missing, replace them.

**A12A1 MODIFICATIONS: 08642-60109****To Replace:**

4. Reconnect cables as follows:
- |       |                         |
|-------|-------------------------|
| A12W1 | A12A2J4 to A12A1J3 (SR) |
| A12W4 | A12A1J1 to A12A3J4 (91) |
- 7A. Make sure mixer access covers secured to casting cover.
- 7B. Check that screws are mounted in the cover in holes marked "C2", "C3", "C26" and "C27". If any are missing replace them.

**A12A2 MODIFICATIONS: 08642-60110****To Replace:**

4. Reconnect cables as follows:
- |       |                          |
|-------|--------------------------|
| A12W1 | A12A2J4 to A12A1J3 (SR)  |
| A12W2 | A12A3J2 to A12A2J3 (907) |
| A12W3 | A12A2J1 to A12A3J5 (902) |
- 7A. Make sure mixer access covers secured to casting cover.
- 7B. Check that screws are mounted in the cover in holes marked "C2", "C3", "C26" and "C27". If any are missing, replace them.



**A12A3 MODIFICATIONS: 08642-60111****To Replace:**

- 2A. Check feedthrough filter network for cracked bodies or bent pins. If the filter network is damaged replace it. (Refer to paragraph 8-24.)
- 2B. Check that gasket is in place under the feedthrough filter network. If it is damaged or missing, replace it.
- 2C. Check that Feedthrough filter network is secured to base.
- 2D. Check that teflon washer is in place on top of feed through filter FL2 (single filter). If it is missing, replace it. This washers prevents feedthrough from shorting to A12A3.
- 4. Reconnect cables as follows:
 

A12W2	A12A3J2 to A12A2J3 (907)
A12W3	A12A2J1 to A12A3J5 (902)
A12W4	A12A1J1 to A12A3J4 (91)
- 7A. Make sure mixer access covers secured to casting cover.

**A13A1 MODIFICATIONS: 08642-60112****To Replace:**

- 4. Reconnect cables as follows:
 

A13W1	A13A1J1 to A13A2J5 (936)
A13W2	A13A1J2 to A13A2J2 (924)
- 6. Place cover over PC Board. Replace screws finger tight. Do not tighten yet.
- 7. Replace round transistor heatsink on outside of casting cover. Heat sink is screwed onto shaft of transistor mounted on A13A1. Do not overtighten.
- 8. Tighten screws in casting cover starting in the center and working outward.

**A13A2 MODIFICATIONS: 08642-60113****To Replace:**

- 2A. Check feedthrough filter network for cracked bodies or bent pins. If the filter network is damaged replace it. (Refer to paragraph 8-24.)
- 2B. Check that gasket is in place under the feedthrough filter network. If it is damaged or missing, replace it.
- 2C. Check that Feedthrough filter network is secured to base.

## 4. Reconnect cables as follows:

A13W1	A13A1J1 to A13A2J5 (936)
A13W2	A13A1J2 to A13A2J2 (924)

**A14 MODIFICATIONS: HET SWITCH (A14U1)****To Replace: A14U1**

1. Secure A14U1 to base with two screws (use flat washer and lock washer with each).
2. Plug wiring harness into A14A3J5.
3. Reconnect cables as follows:

A14W2	A14A3J3 to A14U1J1 (912)
A14W3	A14A3J1 to A14U1J4 (914)
A14W4	A14U1 to A14A3J5 (WIRING HARNESS)

Red wire to rear feedthrough filter.  
Brown wire to front feedthrough filter.

**A14A2 MODIFICATIONS: 08642-60115****To Replace:**

- 2A. Check feedthrough filter network for cracked bodies or bent pins. If the filter network is damaged replace it. (Refer to paragraph 8-24.)
- 2B. Check that gasket is in place under the feedthrough filter network. If it is damaged or missing, replace it.
- 2C. Check that Feedthrough filter network is secured to base.
4. Reconnect cables as follows:
 

A14W1	A14A2J4 to A14A3J2 (916)
-------	--------------------------
6. Place cover over PC Board. Replace screws finger tight. Do not tighten yet.
7. Replace round transistor heatsink on outside of casting cover. Heat sink is screwed onto shaft of transistor mounted on A13A1. Do not overtighten.
8. Tighten screws in casting cover starting in the center and working outward.

**A16 ATTENUATORS: A16AT1 and A16AT2 (Option 003 only)****To Replace:**

1. Loosely secure the attenuator to the base with four screws inserted from opposite side of base. These screws must be left slightly loose to facilitate connecting the semi-rigid cable.
2. Reconnect cables as follows:
 

A16W1	A16AT1J2 to A16AT2J2 (SR)
A16W2	A16AT2J1 to A16A2J1 (SR)
A16W8	A16AT1 to A16A1J1 odd numbered pins (RIBBON CABLE)
	A16AT2 to A16A1J1 even numbered pins (RIBBON CABLE)
3. Tighten screws securing attenuator to base.

**A19A1 MODIFICATIONS: 08642-60118****To Replace:**

4. Reconnect cables as follows:
 

A19W7	A19K1, K2 to A19A1J4 (SR)
A19W8	A19AT1 to A19A1J1 odd numbered pins (RIBBON CABLE)
	A19AT2 to A19A1J1 even numbered pins (RIBBON CABLE)
6. Omit this step.

**A19A2 MODIFICATIONS: 08642-60119****To Replace:**

4. Reconnect cables as follows:
 

A19W6	A19AT2J1 to A19A2J1 (SR)
-------	--------------------------
6. Omit this step.

**A19A3 MODIFICATIONS: 08642-60120****To Replace:**

- 2A. Check feedthrough filter network for cracked bodies or bent pins. If the filter network is damaged replace it. (Refer to paragraph 8-23.)

**A16 ATTENUATORS: A16AT1 and A16AT2 (Option 003 only)**

**To Replace:**

1. Loosely secure the attenuator to the base with four screws inserted from opposite side of base. These screws must be left slightly loose to facilitate connecting the semi-rigid cable.
2. Reconnect cables as follows:
 

A16W1	A16AT1J2 to A16AT2J2 (SR)
A16W2	A16AT2J1 to A16A2J1 (SR)
A16W8	A16AT1 to A16A1J1 odd numbered pins (RIBBON CABLE)
	A16AT2 to A16A1J1 even numbered pins (RIBBON CABLE)
3. Tighten screws securing attenuator to base.

**A19A1 MODIFICATIONS: 08642-60118**

**To Replace:**

4. Reconnect cables as follows:
 

A19W7	A19K1, K2 to A19A1J4 (SR)
A19W8	A19AT1 to A19A1J1 odd numbered pins (RIBBON CABLE)
	A19AT2 to A19A1J1 even numbered pins (RIBBON CABLE)
6. Omit this step.

**A19A2 MODIFICATIONS: 08642-60119**

**To Replace:**

4. Reconnect cables as follows:
 

A19W6	A19AT2J1 to A19A2J1 (SR)
-------	--------------------------
6. Omit this step.

**A19A3 MODIFICATIONS: 08642-60120**

**To Replace:**

- 2A. Check feedthrough filter network for cracked bodies or bent pins. If the filter network is damaged replace it. (Refer to paragraph 8-24.)

3. Hold switches in place and mount to base with two screws. Each screw takes a washer.
4. Reconnect other cables as follows:

A19W2	A19K2J2 to A19AT1J1 (SR)
A19W3	A19K1J3 to A19A3J1 (SR)
A19W4	A19K2J3 to A19A3U2J2 (SR)

#### 8-24. MODULE FEEDTHROUGH FILTER NETWORK

Removal Time:	2 min
Replacement Time:	2 min
Tools Required:	<i>Pozidrive screwdriver.</i>

#### To Remove: Filters

1. Remove PC board assembly under which filters are mounted.
2. Remove two screws securing filter to base. Carefully pull filter network out of module.

#### To Replace: Filters

1. Place filter gasket over feedthrough hole in casting base.
2. Inspect filter network for cracked or broken filter bodies. If filter network is intact, place the network through the feedthrough hole with the longer set of leads through the casting. Be sure gasket remains in place.
3. Secure filter to base with two screws.
4. Replace PC board. (Refer to paragraph 8-22 **MODIFICATIONS** for the module you are repairing.)

3. Hold switches in place and mount to base with two screws. Each screw takes a washer.
4. Reconnect other cables as follows:

A19W2	A19K2J2 to A19AT1J1 (SR)
A19W3	A19K1J3 to A19A3J1 (SR)
A19W4	A19K2J3 to A19A3U2J2 (SR)

#### 8-24. MODULE FEEDTHROUGH FILTER NETWORK

Removal Time:	2 min
Replacement Time:	2 min
Tools Required:	<i>Pozidrive screwdriver.</i>

#### To Remove: Filters

1. Remove PC board assembly under which filters are mounted.
2. Remove two screws securing filter to base. Carefully pull filter network out of module.

#### To Replace: Filters

1. Place filter gasket over feedthrough hole in casting base.
2. Inspect filter network for cracked or broken filter bodies. If filter network is intact, place the network through the feedthrough hole with the longer set of leads through the casting. Be sure gasket remains in place.
3. Secure filter to base with two screws.
4. Replace PC board. (Refer to paragraph 8-22 **MODIFICATIONS** for the module you are repairing.)

**8-25. MODULE: A5**

Removal Time:	2 min
Replacement Time:	2 min
Tools Required:	<i>Pozidrive screwdriver, torque driver Torxhead bits</i>

**To Remove**

1. Remove top cover. (Refer to paragraph 8-3.)
2. Remove A3 and A4 Modules. (Refer to paragraph 8-5 and 8-6.)
3. Open front panel (refer to paragraph 8-7: except Option 002, paragraph 8-8: Option 002 only).
4. Remove A2 Module. (Refer to paragraph 8-9.)
5. Remove seven screws in modulation shield (metal plate behind A2). Pull shield out of instrument.
6. Remove left (black) controller guide metal mounting bracket (two screws).
7. Remove two screws in left (black) controller guide.
8. Turn instrument on its side and remove four screws on rear edge of front bottom cover. Pull cover toward rear panel to disengage from front frame.
9. Remove two screws holding left (black) controller guide to bottom of A5 Module and pull guide out of instrument.
10. Remove two screws on far right side holding right (white) controller guide.
11. Disconnect all cables from A5 Module.
12. Remove seven panhead screws securing board to brace. DO NOT remove six flathead screws visible through holes in center section of A5 Module.
13. Pull Module out through bottom of instrument.

**To Replace**

1. Push A5 Module into instrument through bottom of instrument and align with front brace. Be sure front brace insulator is in place behind A5.
2. Plug HP-IB Cable (W12) into bottom left corner of A5 at A5J20 and A5J21. Red stripe on cable faces front panel. Dress W12 between standoffs on side of frame.

- Loosely secure A5 and insulator to front brace with seven screws. When all seven screws are in place, tighten each one.



*Cables W14 and W15 must be properly dressed into notch provided in left controller guide. Improperly dressed cables can be punctured by screws when securing guide and bracket to frame.*

- Dress W14 (08642-60010) and W15 (08642-60011) flush against left side of instrument. Mount left (black) controller guide over the cables with two panhead screws. Mount the left guide metal bracket with two flathead screws.
- Replace two screws in right (white) controller guide.
- Reconnect all cables. (Refer to diagram on inside of instrument Top Cover for cable connections.)
- Position the modulation shield into the front frame and loosely secure with seven screws. When all screws are in place tighten each one.
- Replace A2 Module. (Refer to paragraph 8-9.)
- Close front panel. (Refer to paragraph 8-7: Except Option 002, paragraph 8-8: Option 002 only.)
- Replace A3 and A4 Modules. (Refer to paragraph 8-5 and 8-6.)





1. RF MODULE MECHANICAL PARTS

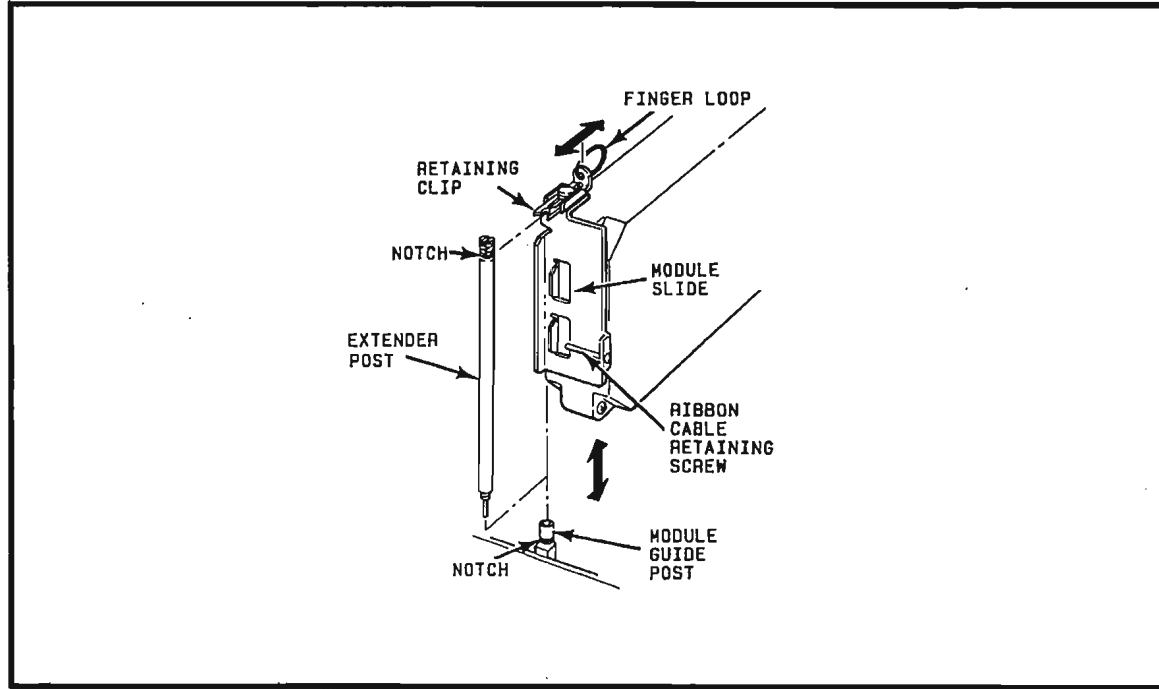

2. A17 MODULE MECHANICAL PARTS

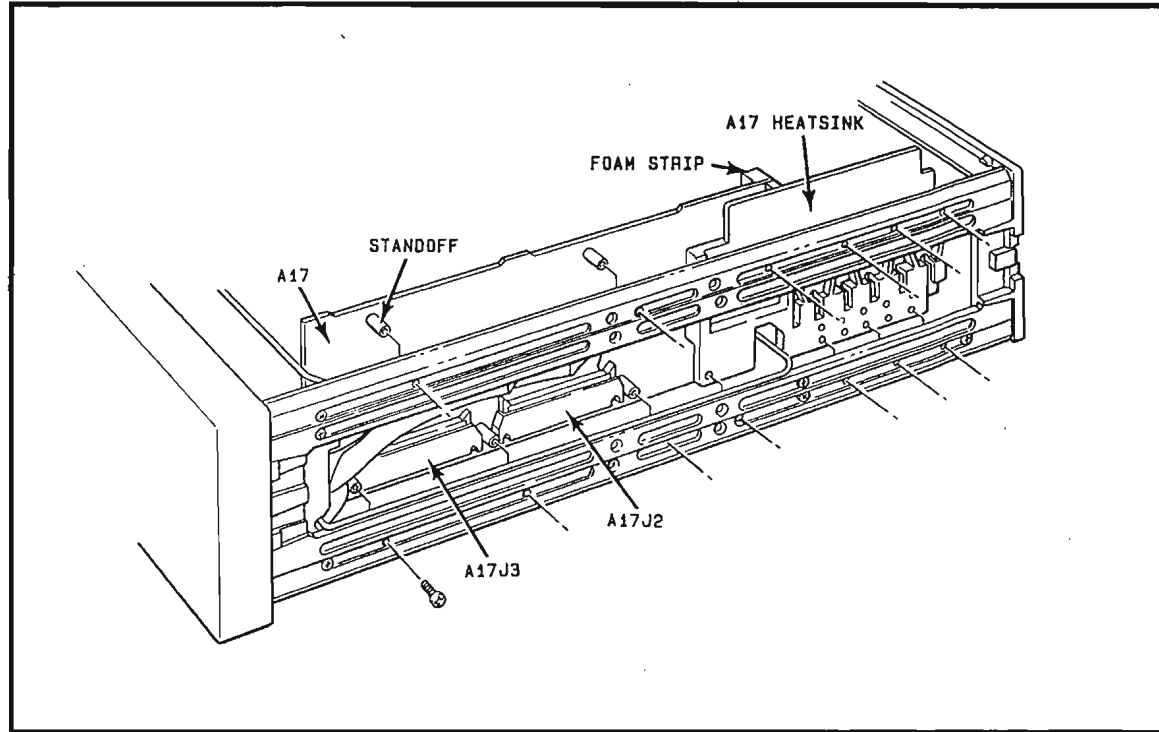

3. A20 AND B1 MECHANICAL PARTS

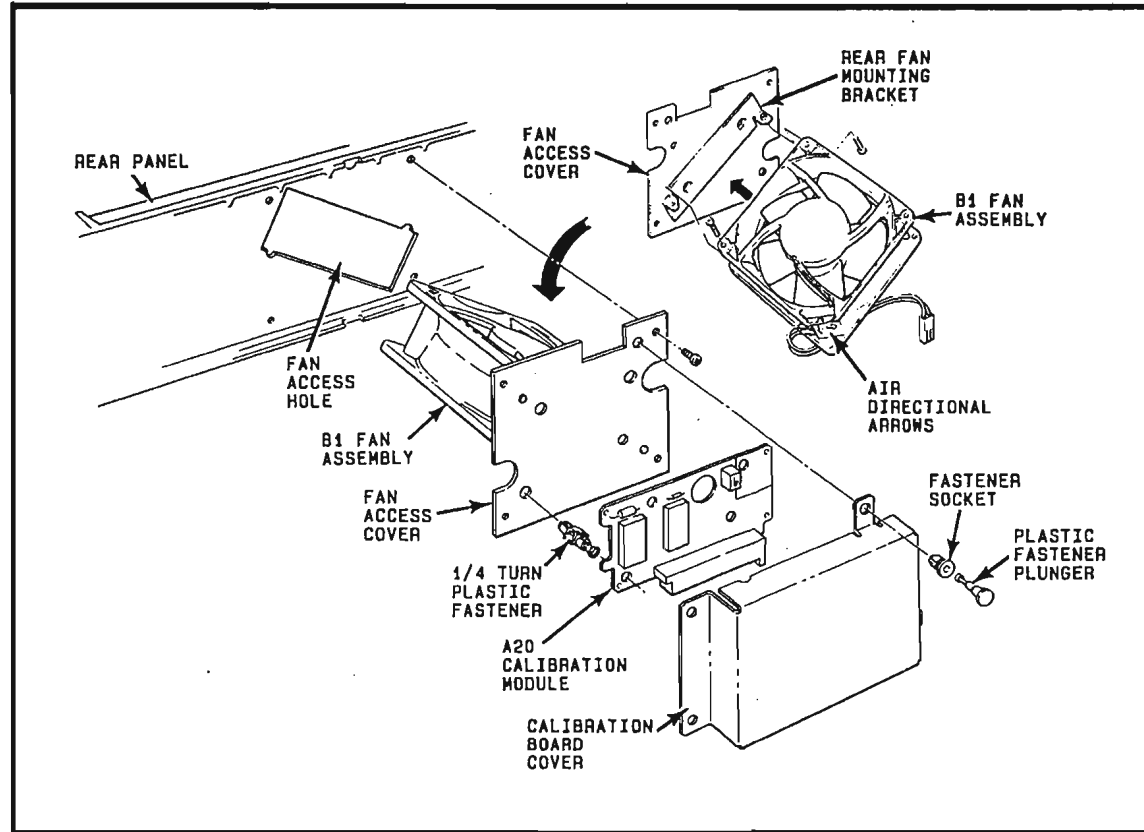

4. A2 CABLE TIES AND CONNECTORS

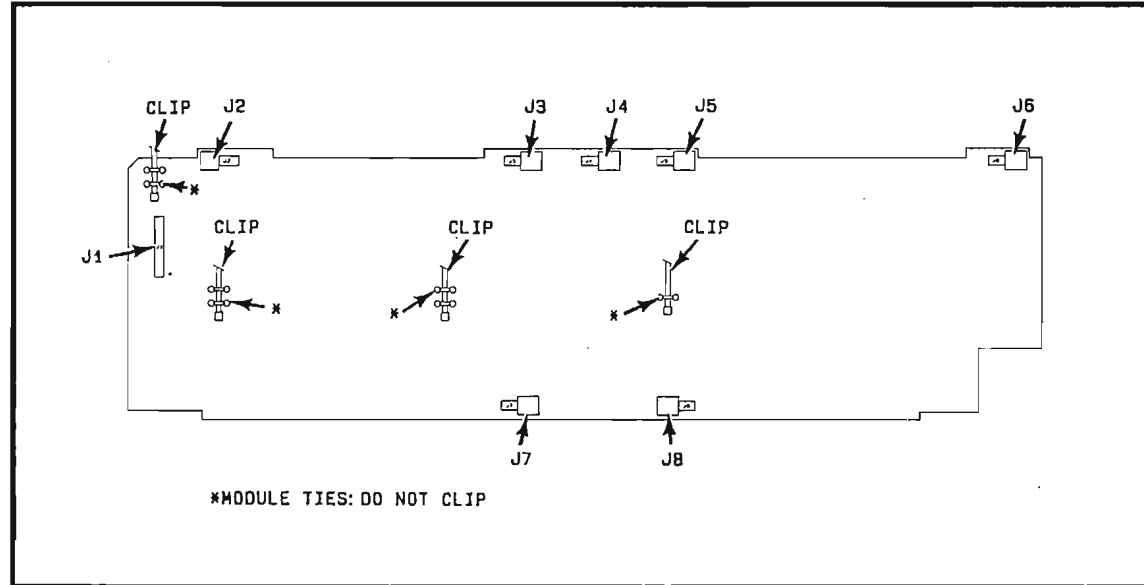

5. A18 MOUNTING SCREWS

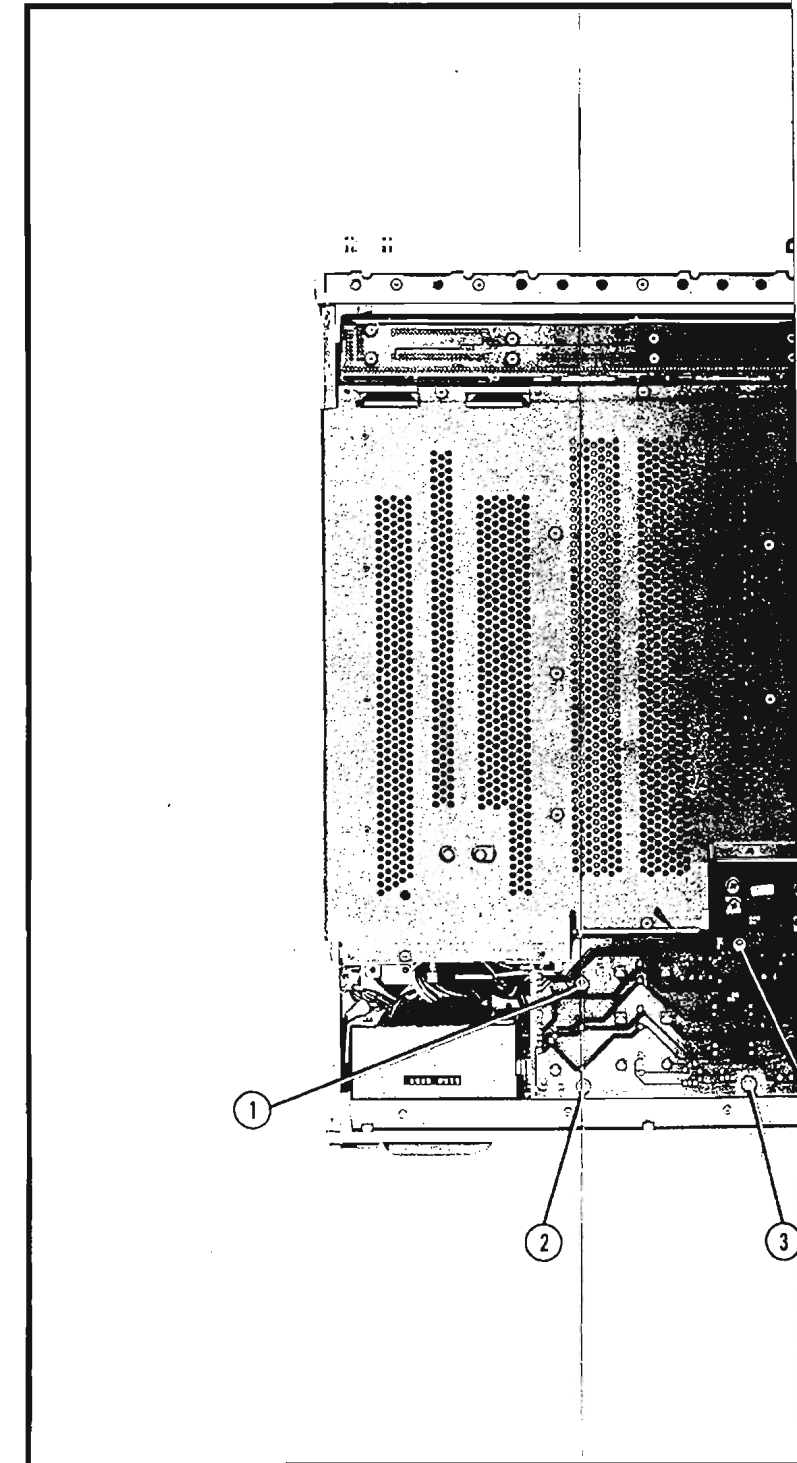
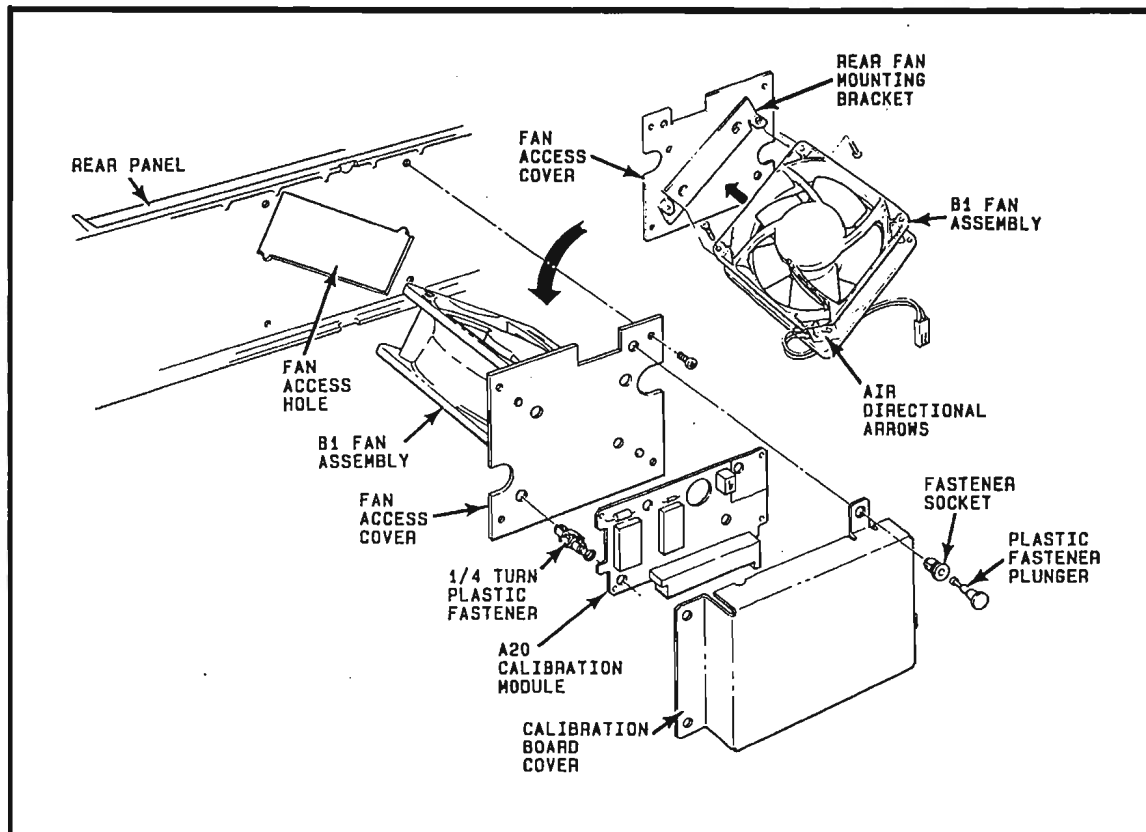
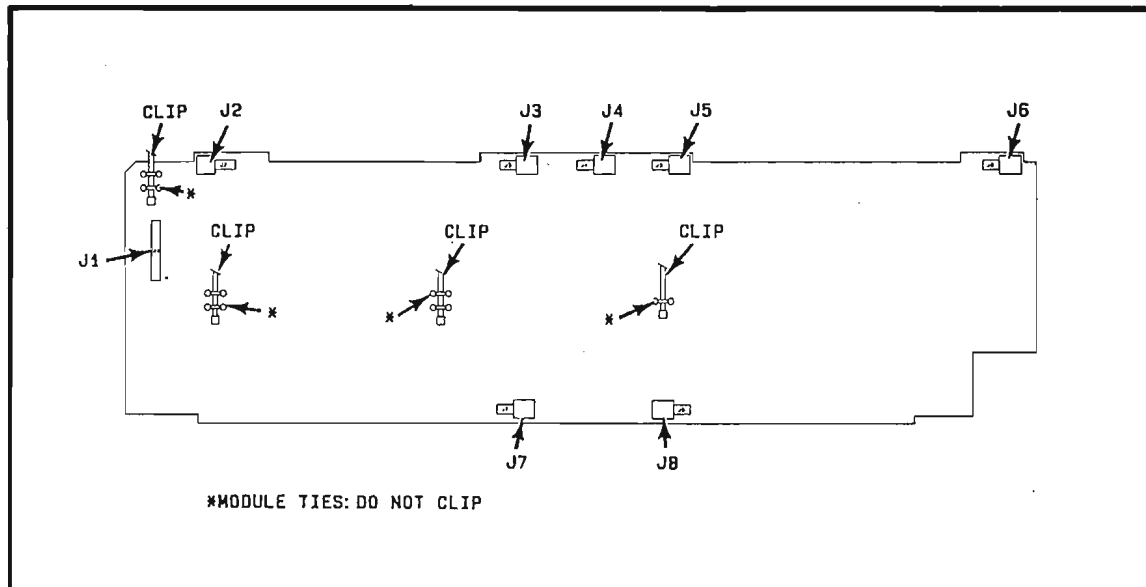

Figure 8B-

3. A20 AND B1 MECHANICAL PARTS



4. A2 CABLE TIES AND CONNECTORS



5. A18 MOUNTING SCREWS

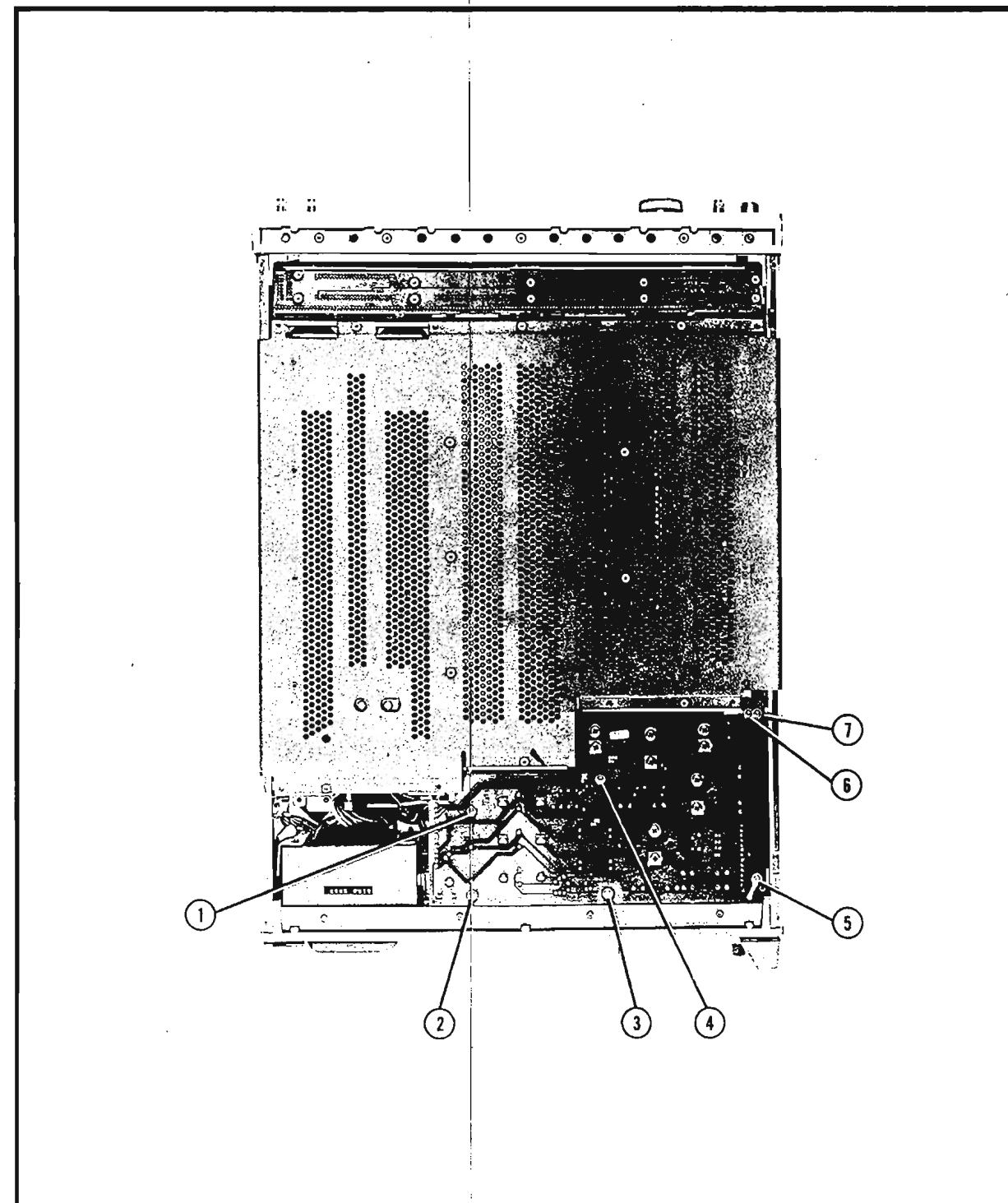
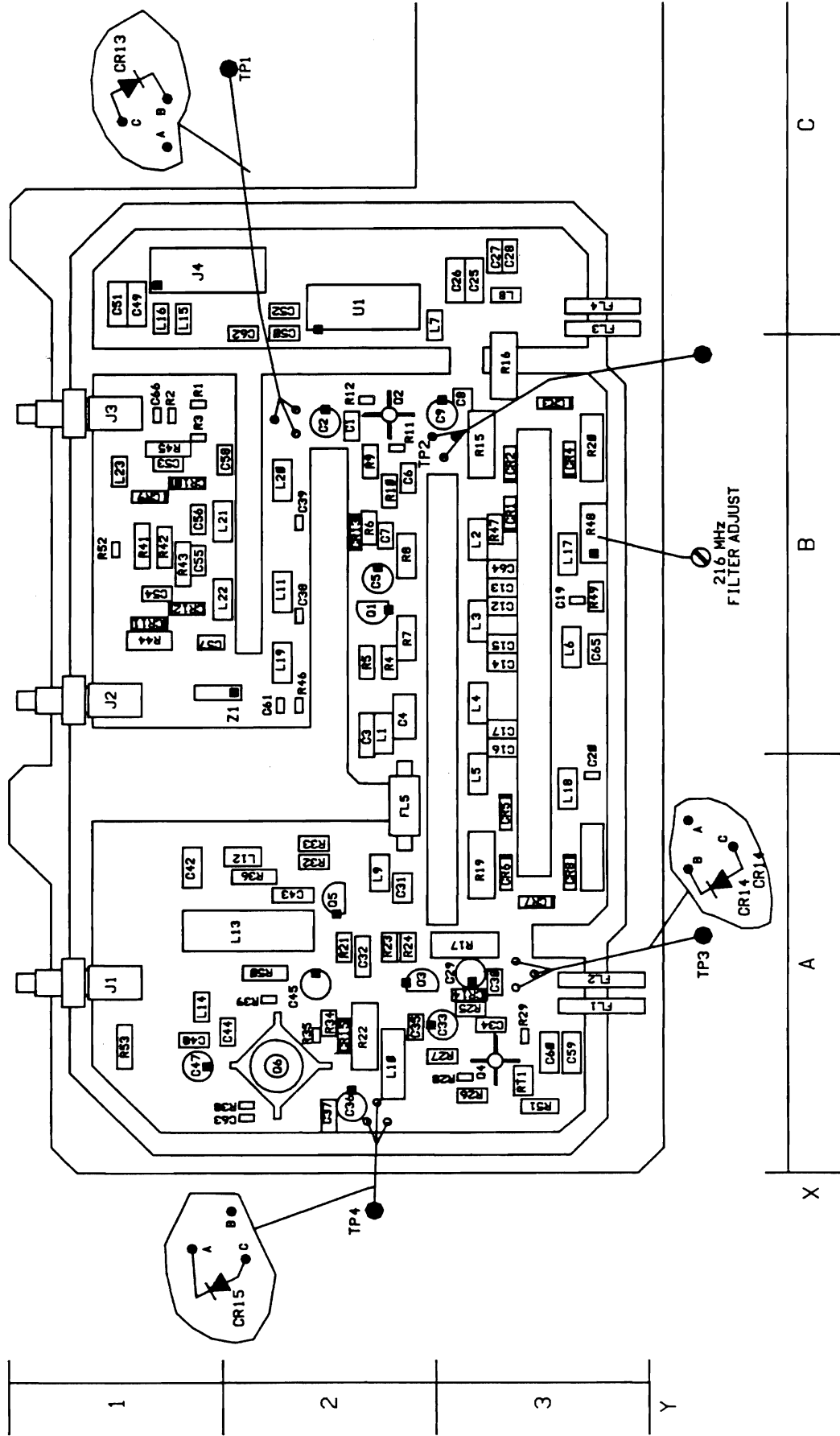

Figure 8B-100 Disassembly Procedures.  
8B-47



Changes to Figure 8Q-106 (2642A to 2807A)

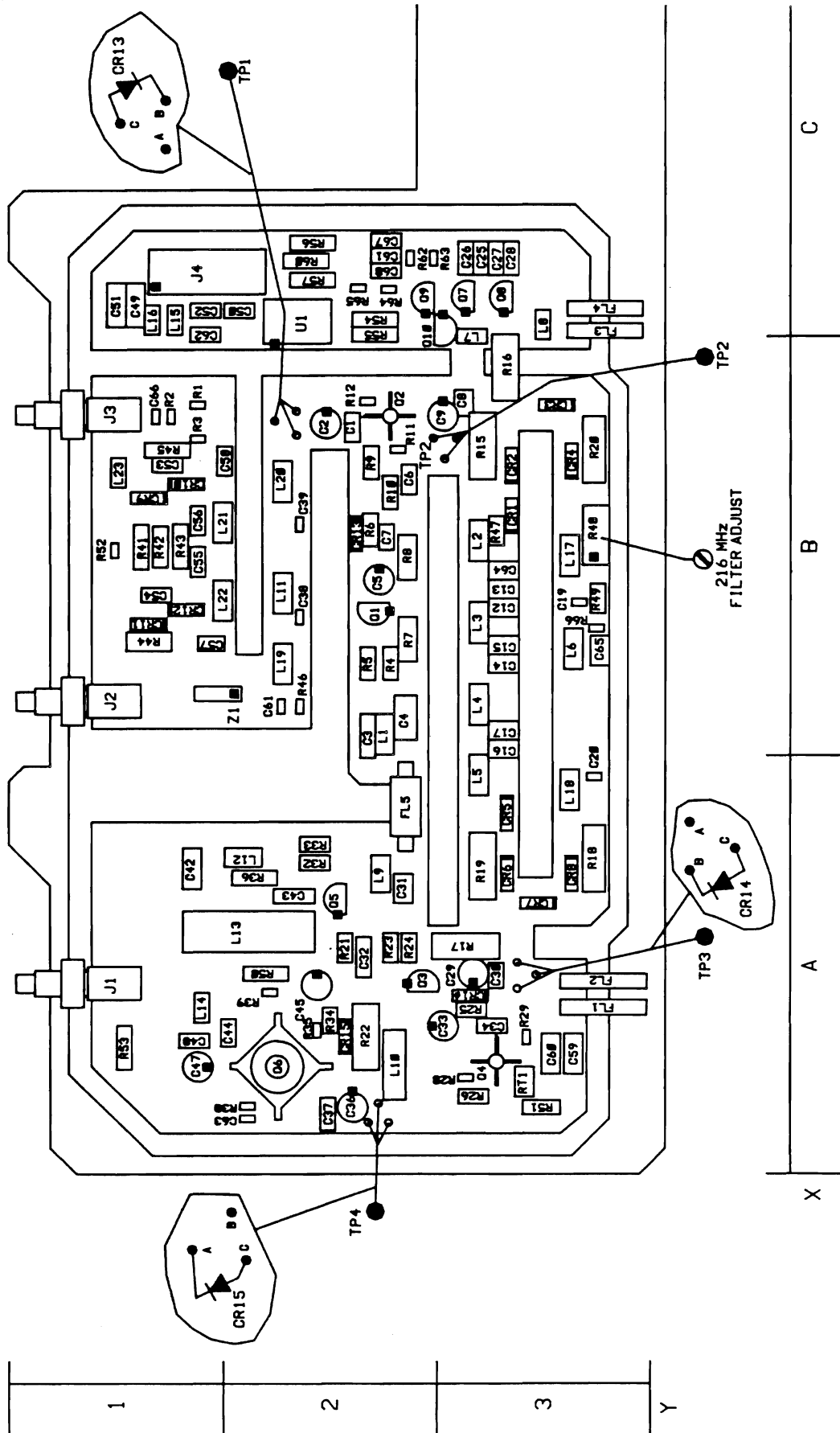

Figure 8Q-106. Component Locator (2825A and above)

SS47

rev.01JUN88

RODYNE ASSEMBLY (Ø8642-6Ø216)

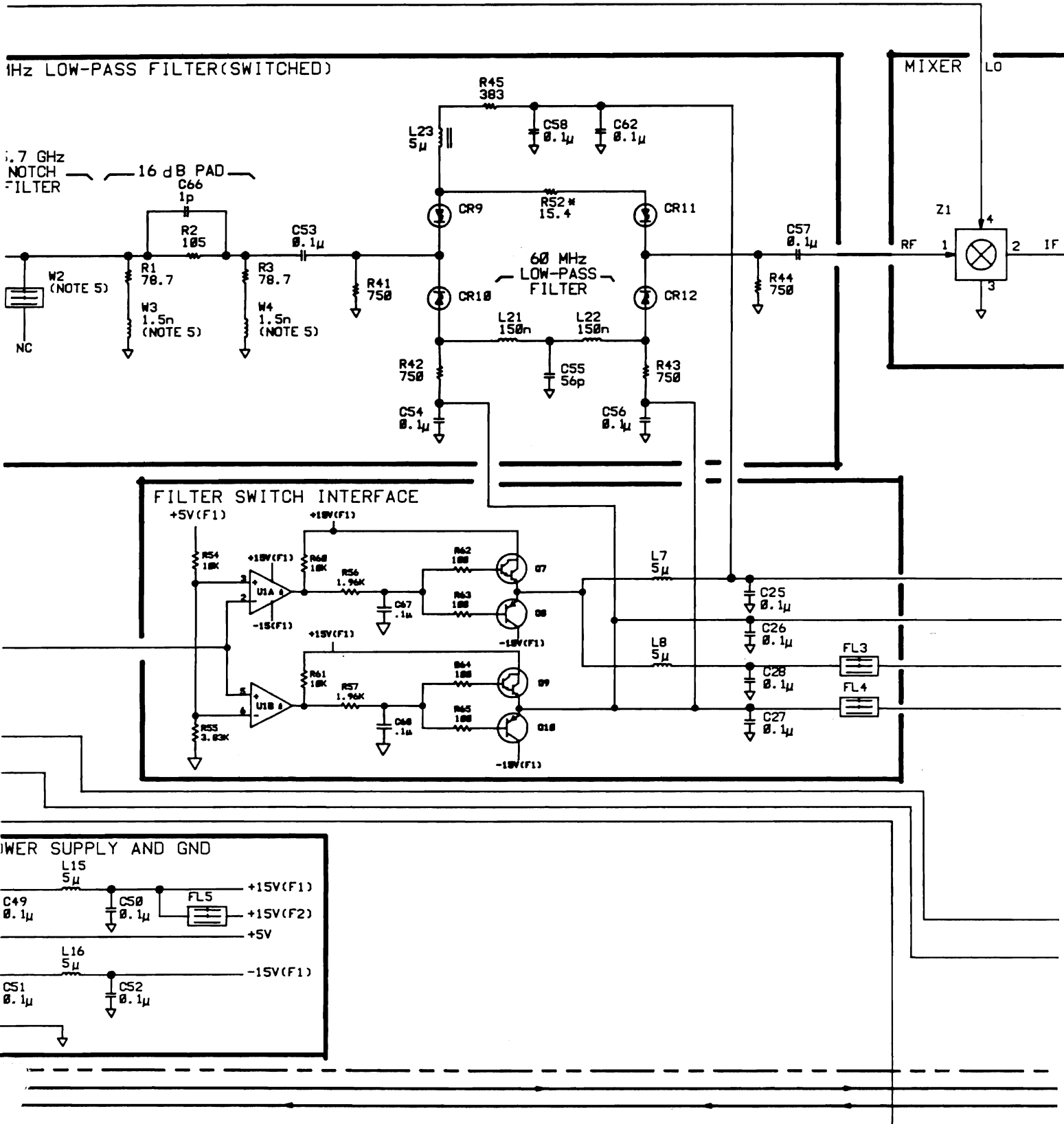
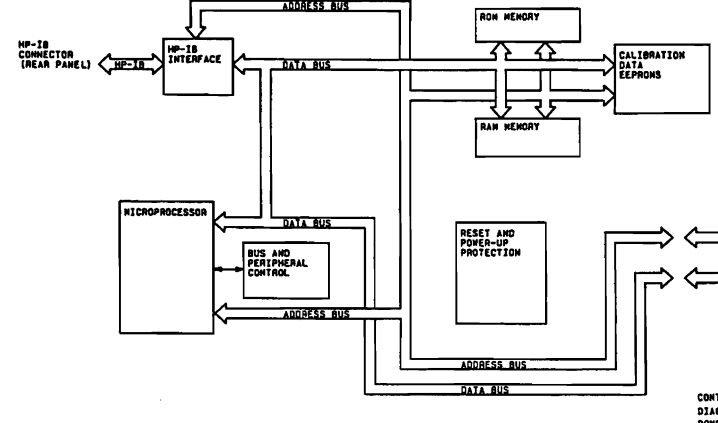

Figure 8Q-107: Service Sheet 47. (2825A and above)

Scans by AntekMedia © 2008

A3 PROCESSOR/MEMORY MODULE



A4 INPUT/OUTPUT LATCH MODULE

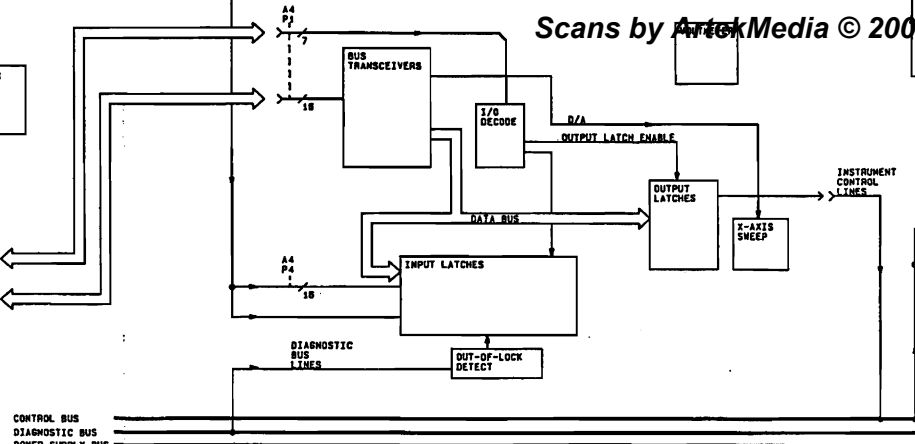

A1 KEYBOARD/LCD DISPLAY MODULE

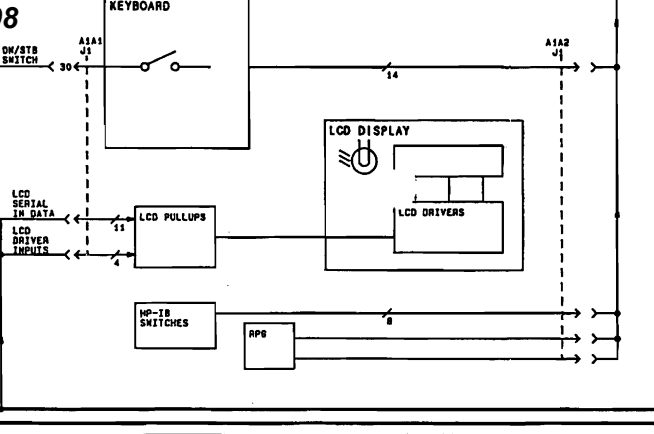

A17, A18 POWER SUPPLY/ATTENUATOR DRIVERS

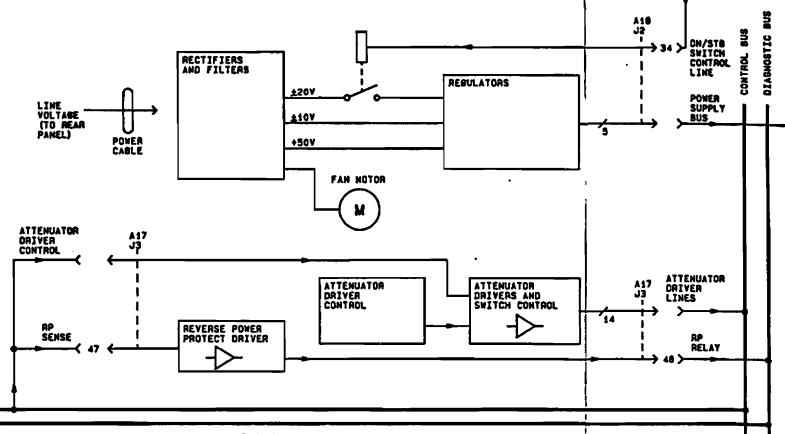

A6 FM LOOP/COUNTER/TIMEBASE MODULE

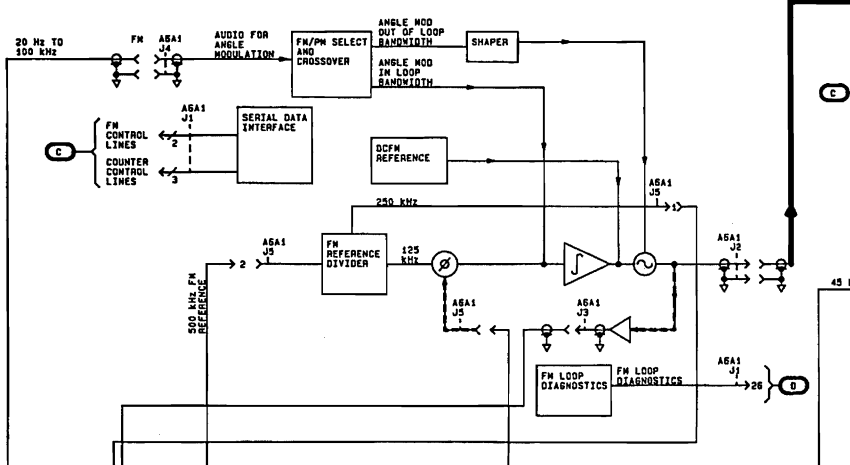

A7 SAWR LOOP MODULE

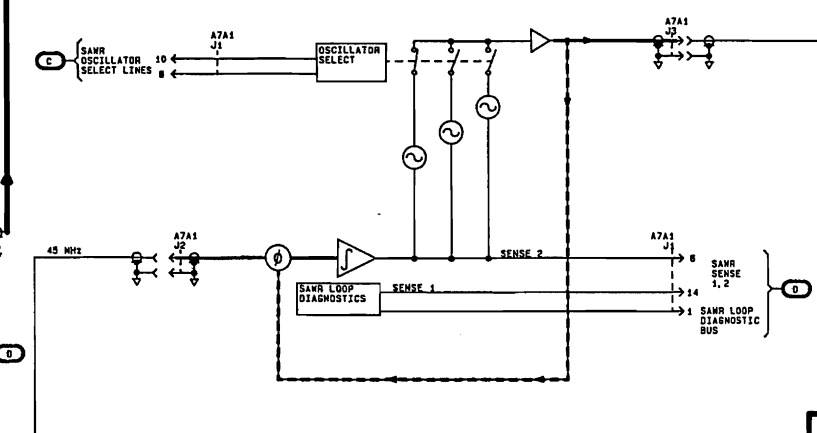

A11 REFERENCE LOOP MODULE

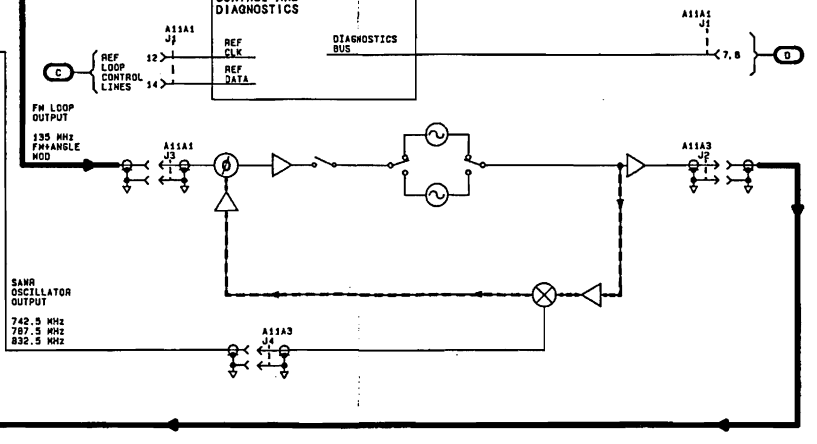

A9 IF LOOP MODULE

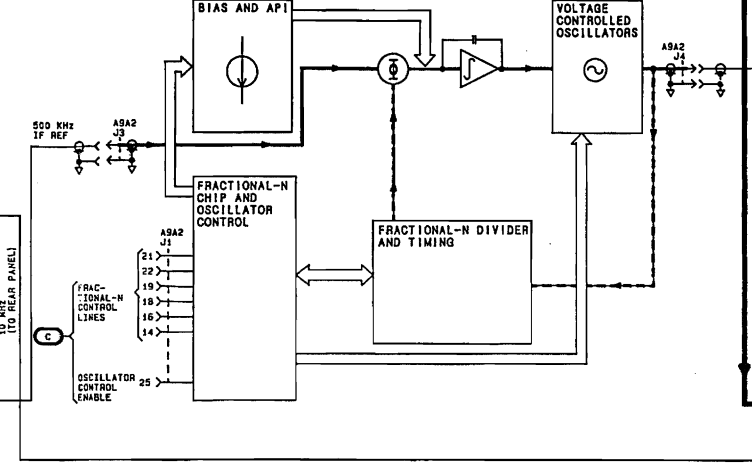

A12 SUM LOOP/DIVIDER MODULE

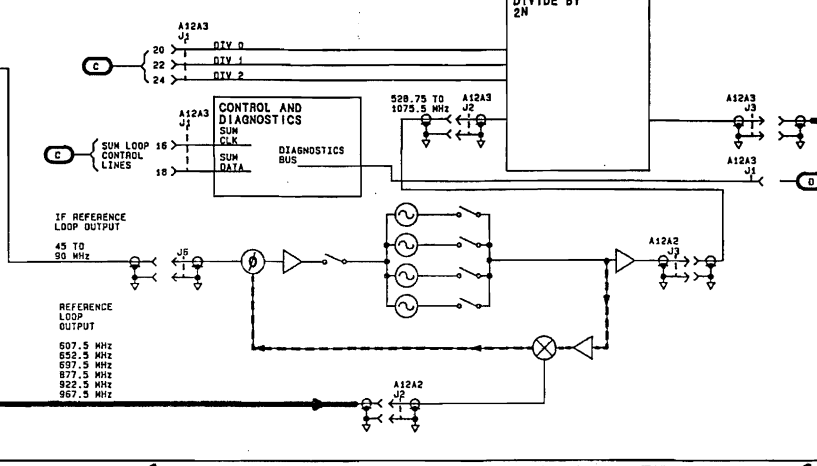

A16 ATTENUATOR MODULE (8642A) A19 DOUBLER/ATTENUATOR MODULE (8642B)

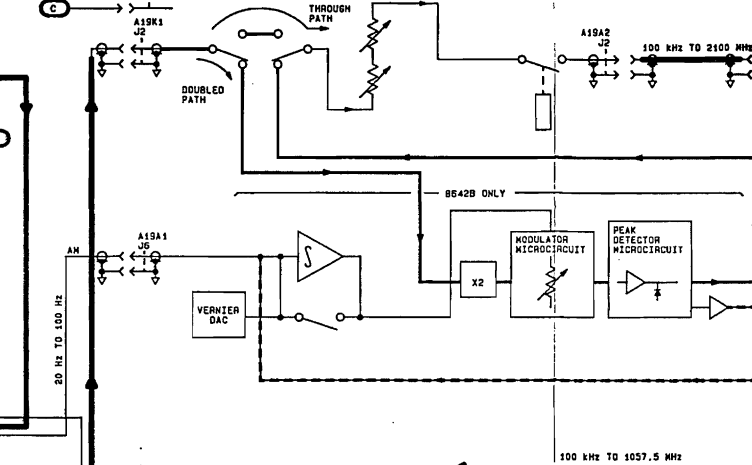

A2 MODULATION MODULE

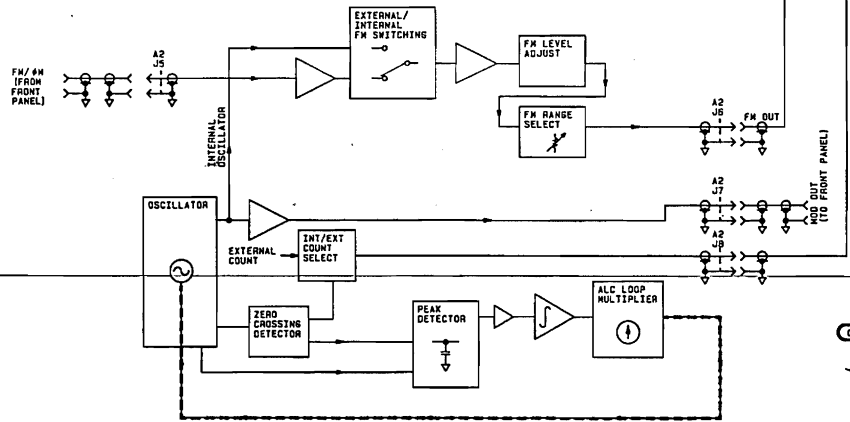

A13 OUTPUT FILTERS/ALC MODULE

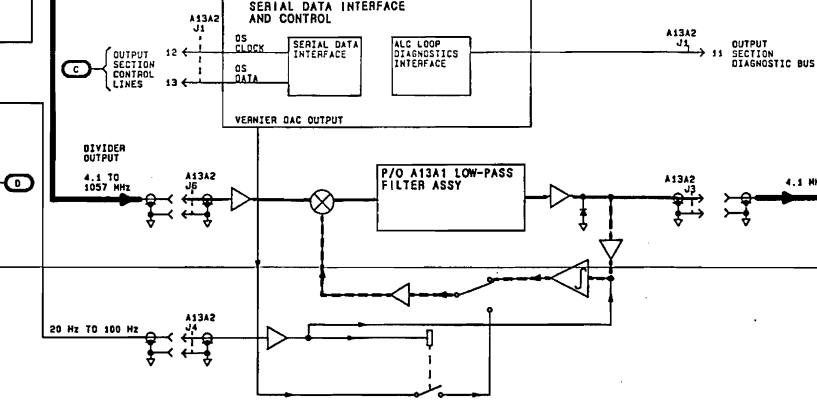

A14 HETERODYNE MODULE

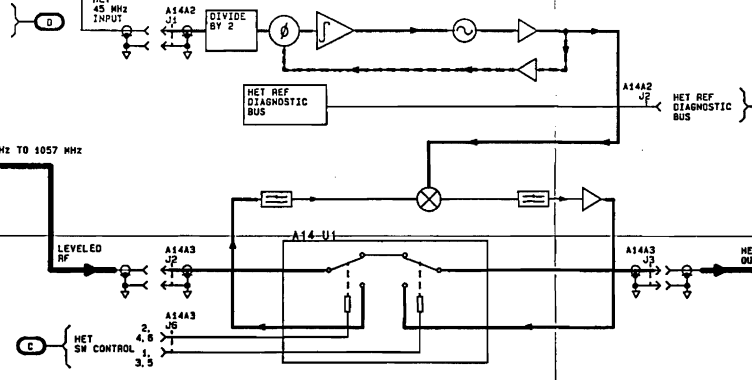

NOTE: POWER SUPPLY LINES ARE DISTRIBUTED TO ALL MODULES THROUGH RIBBON CABLES. TAB TO MODULE OF INTEREST FOR CONNECTOR INFORMATION.

NOTES: 1. All RF Power Levels should be greater than 0 dBm. Check module information in tabbed section for exact levels.  
2. See top inside cover for details of interconnections.

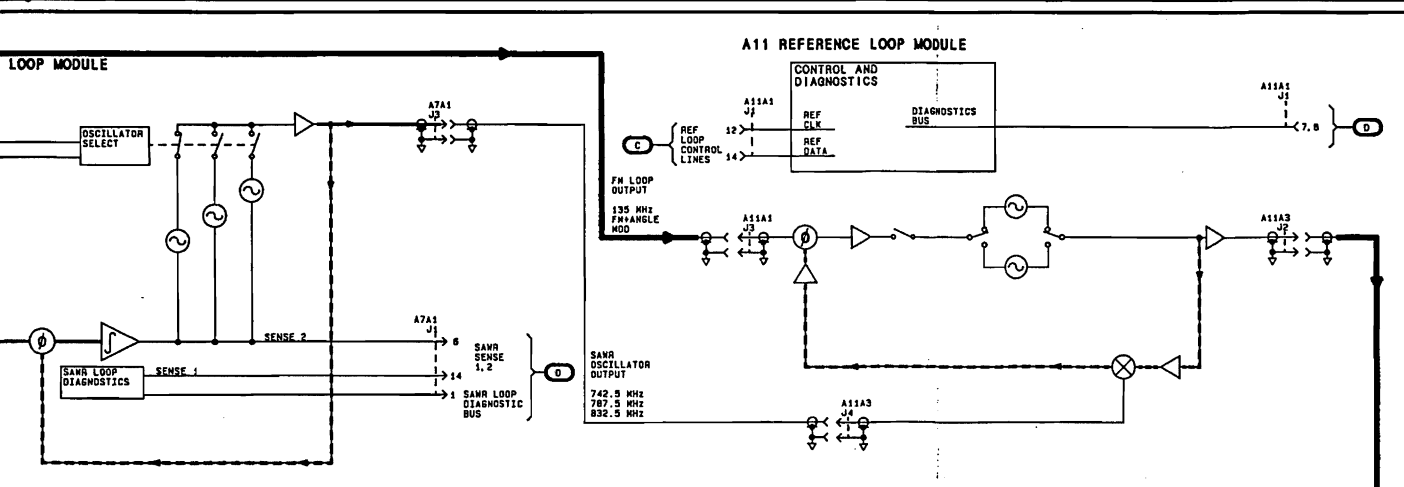
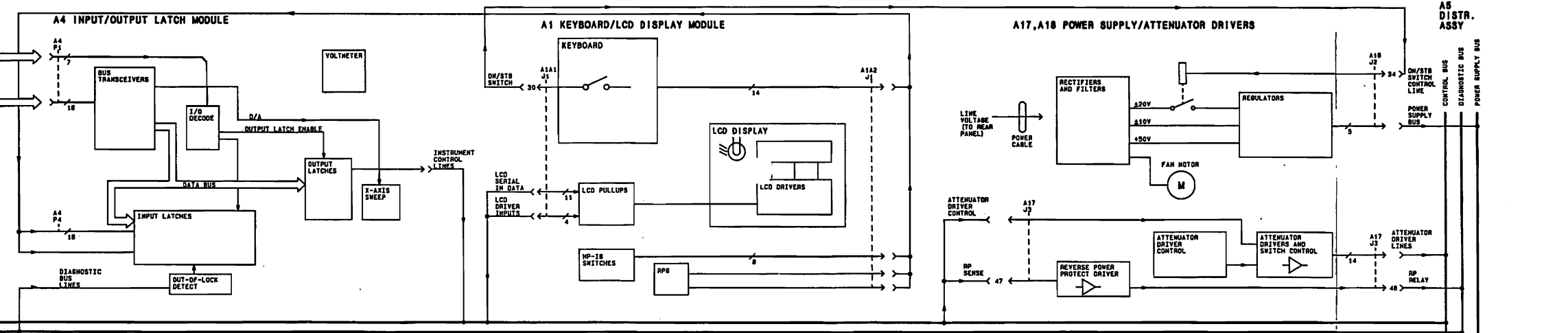

NOTE: POWER SUPPLY LINES ARE DISTRIBUTED TO ALL MODULES THROUGH RIBBON CABLES. TAB TO MODULE OF INTEREST FOR CONNECTOR INFORMATION.

NOTES: 1. All RF Power Levels should be greater than 0 dBm. Check module information in tabbed section for exact levels.  
2. See top inside cover for details of interconnections.

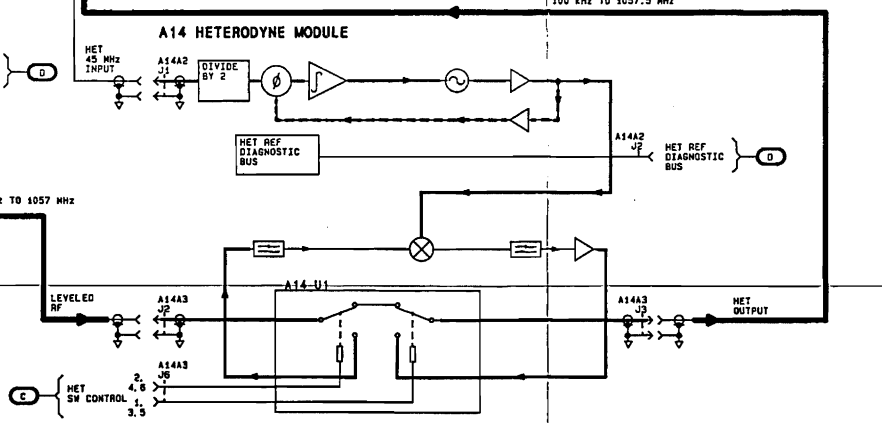
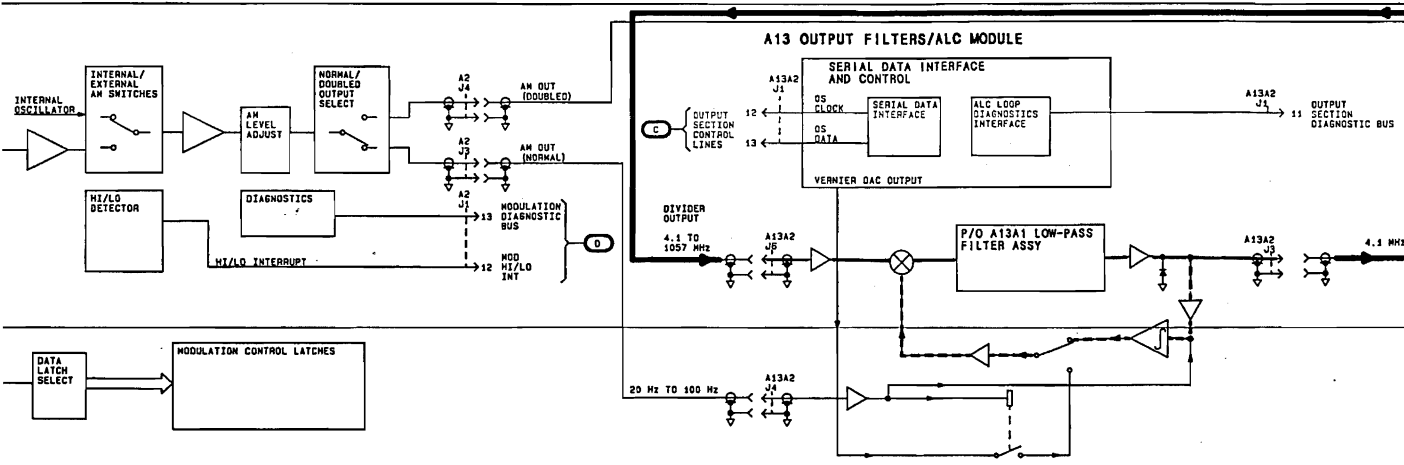
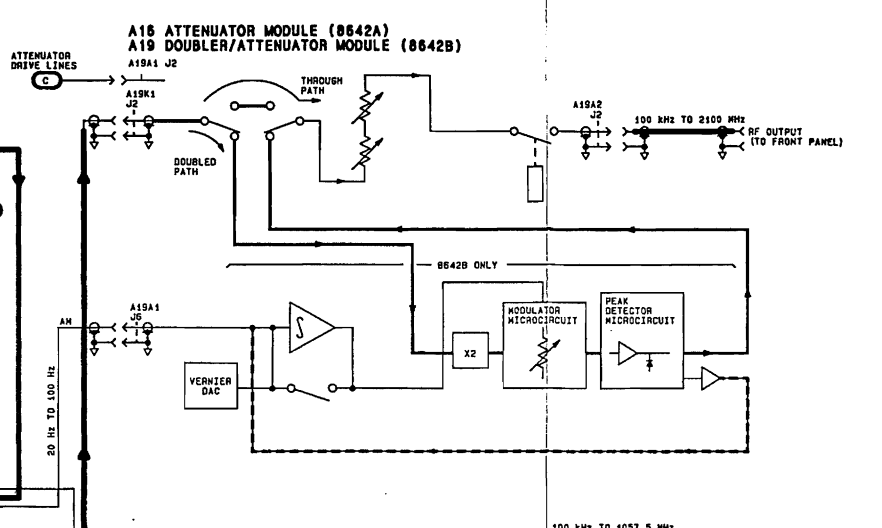
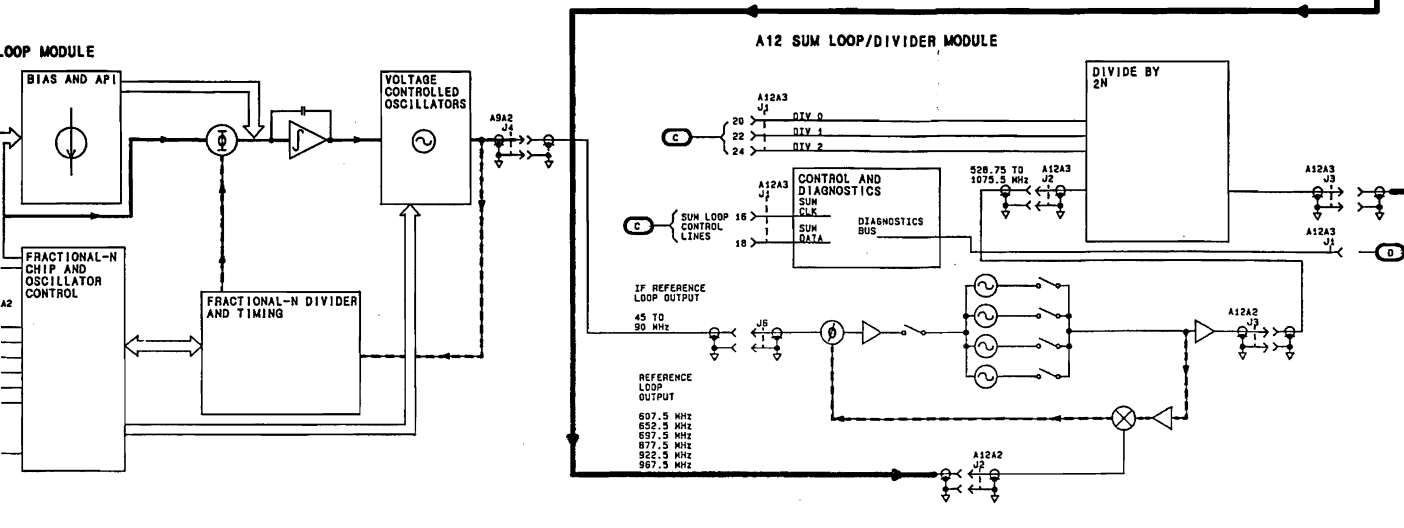

**BD1**  
Figure 8C-101  
8C-101



# CONTENTS

## Section VIII SERVICE

<b>DIAGNOSTICS</b>	
Introduction .....	8D-1
<b>INSTRUMENT LEVEL DIAGNOSTICS</b>	
Instrument Level Diagnostics .....	8D-3
<b>POWER SUPPLY SECTION</b>	
<b>A17 and A18</b> Modules .....	8D-9
<b>CONTROL SECTION</b>	
<b>A1, A3, and A4</b> Modules .....	8D-43
<b>RF SECTION</b>	
<b>A2</b> Modulation Module .....	8D-61
<b>A6</b> FM Loop/Counter/Timebase Module .....	8D-89
<b>A7</b> SAWR Loop Module .....	8D-125
<b>A9</b> IF Loop Module .....	8D-153
<b>A11</b> Reference Loop Module .....	8D-181
<b>A12</b> Sum Loop Module .....	8D-211
<b>A13</b> Output Filter/ALC Module .....	8D-243
<b>A14</b> Heterodyne Module .....	8D-271
<b>A16</b> (Option 003) Attenuator Module .....	8D-307
<b>A19</b> Doubler/Attenuator Module .....	8D-327
<b>REPLACING A MODULE</b>	
Introduction .....	8D-361
Replacing a Module .....	8D-362

---

## DIAGNOSTICS

---

The Diagnostics section of the HP 8642A/B Operating and Service Manual has been taken directly from the HP 8642A/B On-Site Service Manual. When using this section of the manual you will find that certain references have been made for the on-site manual which are not applicable to this manual. These references are listed below.

1. You will read, "The last page of this section is a foldout and should be pulled out now."
    - The foldouts in the Operating and Service manual are in one section. You will need to find the foldout for your module. They are arranged in the following order: Instrument Level Diagnostics, Power Supply Modules, Control Modules and RF Modules.
  2. There are many references to the On-Site Service Kit and its contents, which may or may not be available to you. If you do not have the kit, the contents are listed in the Operating and Service Manual on page 1-17 and 1-18 in Table 1-5. It will be helpful to have the tools and test connectors handy to run the tests.
  3. There are cases where you will be directed to other sections of the On-Site Service Manual. The information in the MECHANICAL PROCEDURES section is found in Assembly/Disassembly of the Operating and Service Manual. References to other sections may be ignored. If you would like to read the information for further understanding, the HP Part Number for the On-Site Service Manual is 08642-90020.
  4. Figures and tables are numbered according to the On-Site Service Manual numbering scheme.
  5. The Exceptional cases section of the manual is not yet available.
  6. There are two page references in the text which will have to be modified. They are:
    - On page 8D-10, page referenced should be 8D-12.
    - On page 8D-271, page referenced should be 8D-274.
  7. Whenever you read "Go to Replacing a Module", go to page 8D-XX.
-



---

**INSTRUMENT LEVEL DIAGNOSTICS**

---

**3A-1. INTRODUCTION****WARNING**

*The HP 8642 is extremely heavy. Do not lift or carry the instrument without assistance.*

*If the instrument is rack mounted, do not pull the instrument from the rack without assistance.*

The **INSTRUMENT LEVEL DIAGNOSTICS (ILD)** are the first level of troubleshooting for the **HP 8642**. The objective of this group of tests is to isolate the source of a detected failure to the correct section of the instrument: **Power Supply, Control or RF Section**. The **ILD** should be used to determine the appropriate place in the instrument to begin module level troubleshooting.

**NOTE**

*Testing at this level requires two BNC coax cables not supplied in the On-Site Service Kit.*

**Test Instructions**

1. The last page in this group of tests is a foldout and should be pulled out now.
  2. Find **INSTRUMENT LEVEL DIAGNOSTICS** on the foldout.
  3. Use the Task Sequence Diagram, shown under **INSTRUMENT LEVEL DIAGNOSTICS** to direct you through the testing process. Each Task Arrow shown in the diagram indicates a task title and task number. The tasks are numbered according to the order in which they are arranged in this section. Turn to the task indicated and complete the procedure.
  4. After completing the procedure, return to the Task Sequence Diagram on the foldout and determine the next task to be performed.
  5. Begin now by performing the first task shown on the diagram.
-

**INSTRUMENT LEVEL DIAGNOSTICS**

Type:	Instrument Level Self Test	IL.01
Run Time:	3 min 30 sec	
Set-up Time:	1 min	

The Instrument Level Self Test is designed to check the operation of each module in the instrument.

**Run Test**

1. **INSTR PRESET** **SHIFT**  
(Hold shift key until "100.000000MZ -140.0DM" appears, to override 20 second reset test.)
2. **SHIFT** **SPCL** **3** **3** **0** **HZ**.
3. When "WAITING FOR SET-UP 3 .V24" appears:
  - Connect BNC Tee connector, from On-Site Service Kit, to "FM/ΦM INPUT". (See foldout for setup diagram.)
  - Connect a coax cable from Tee connector to "MOD OUTPUT".
  - Connect a coax cable from Tee to "AM/PULSE INPUT"
  - **HZ** to continue.
4. When test is complete "DIAG DONE HIT MSSGS .VI" will appear:
  - Use **MSSG** to scroll through messages.
  - Record each module number indicated. (See Front Panel Diagram on foldout to locate module number in display message.)
5. Return to foldout:
  - Determine next task by comparing test results to conditions shown in each INSTRUMENT.

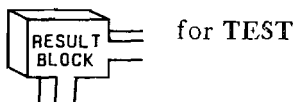

**INSTRUMENT LEVEL DIAGNOSTICS**

Type:	Supply Lines Check	<b>IL.02</b>
Run Time:	2 min	
Set-up Time:	2 min	

1. Remove Top Cover. (See table on foldout in **MECHANICAL PROCEDURES** to locate Top Cover removal information.)
2. Connect external DC voltmeter ground lead to instrument's chassis.
3. Measure Power Supply output voltage levels on A17 Module at test points TP1 through 5. (See Top View Diagram on inside of Top Cover for test point locations and voltage levels.) Voltages should be within approximately 1% of those shown with test points on Top View Diagram.
4. The tuning screws located next to A17TP1 through 5, can be used to fine tune voltage levels which are slightly high or low.

**COMMENT**

*The voltages measured at A17TP1 through 5 are being fed back from sense points on the A5 Assembly. A correct measurement verifies the presence of the voltage on the A5 Distribution Assembly.*

5. Record the results.
6. Return to foldout:
  - Determine next task by comparing test results to conditions shown in each **SUPPLY.**

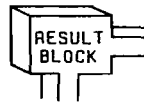

for **CHECK POWER SUPPLY.**

---

**INSTRUMENT LEVEL DIAGNOSTICS**

---

Type:	Identify Conditions	<b>IL.03</b>
Run Time:	N/A	
Set-up Time:	N/A	

The operating conditions which will cause the **Instrument Level Self Test** to pass are listed below. Find the condition which describes your circumstances.

- Condition 1:**      **Instrument Level Self Test (ILST)** did not detect a known failure.
- Condition 2:**      **Instrument Level Self Test (ILST)** was run to confirm correct operation of instrument.

**Condition 1**

**Output Power Level Failure:** To isolate output power level problems which occur at power levels above **-10dBm** and are greater than **10 dB** out of specification, go to **A14 MODULE LEVEL DIAGNOSTICS (MLD)** section. For output power level problems which occur only at settings below **-10dBm** or are less than **10 dB** out of specification, go to **EXCEPTIONAL CASES** section.

**Other Failures:** To isolate failures which can be detected by the internal diagnostics when the **HP 8642** is set to a specific operating condition, go to the **MLD** section for the module indicated by the instrument. If two or more failures are indicated, go to the **MLD** section for the failing module with the lowest **Troubleshooting Order Number** (see **MODULE TROUBLESHOOTING ORDER** on the foldout).

To troubleshoot failures which cannot be detected by the internal diagnostics, go to **EXCEPTIONAL CASES** section.

**Intermittant Failures:** To troubleshoot intermittent failures, turn to **EXCEPTIONAL CASES** section.

**Execution Errors:** Certain incompatible operating conditions will cause service messages to come up. Check for operating modes which do not comply with the **HP 8642's** operating specifications. (Refer to **Section III, OPERATIONS**, in the **HP 8642A/B SYNTHESIZED SIGNAL GENERATOR OPERATING MANUAL** for detailed operating information.)

---

---

**INSTRUMENT LEVEL DIAGNOSTICS**

---

**Condition 2**

**Repair Confirmation:** If **Instrument Level Self Test** was able to detect failure before repair was made; a passing test now indicates repair has corrected failure. If **ILST** was not able to detect failure prior to repair, check instrument in operating condition which indicated failure.

**Operation Check:** The **ILST** checks 80% of the instrument's overall operation.



---

**MODULE TROUBLESHOOTING ORDER**

---

Type:	Module Priority	IL.04
Run Time:	N/A	
Set-up Time:	N/A	

A troubleshooting priority level has been established for each module. Failing modules must be tested in their order of priority.

1. Find **MODULE TROUBLESHOOTING ORDER** on fold-out. This table lists all **HP 8642** modules covered by on-site diagnostics. The modules are listed in the order which you should troubleshoot them.
2. If the **Instrument Level Self Test** has indicated two or more **failing** modules, use the table to determine which **failing** module has lowest **Troubleshooting Order** number.
3. Use index tabs to locate **Module Level Diagnostics** for **failing** module with lowest **Troubleshooting Order** number.
4. Return to **Task Sequence Diagram** on foldout.

---

## POWER SUPPLY SECTION

---

### 3B-1. INTRODUCTION

The **MODULE LEVEL DIAGNOSTICS (MLD)** contained in this section are used to further interrogate the **Power Supply Section** modules: **A17 Power Supply Regulators/Attenuator Drivers Module** and **A18 Power Supply Rectifier/Filter Module**. The objective is to isolate the failure to a module or to a part on which this section depends for operation.

#### WARNING

*Servicing instructions are for use by service trained personnel only. To avoid dangerous electric shock, do not perform any servicing unless qualified to do so.*

*Some procedures described in this manual are performed with power supplied to the instrument while protective covers are removed. Energy levels at certain points may, if contacted, cause personal injury.*

*Capacitors inside the instrument may still be charged even if the instrument has been disconnected from its source of supply.*

*For continued protection against fire hazard, replace the line fuse(s) only with 250v fuse(s) of the same current rating and type (for example, normal blow, time delay, etc.) Do not use repaired fuses or short circuited fuseholders.*

*The left rear portion of the chassis becomes hot during operation. A cooling period may be desired before servicing modules in this area. To avoid personal injury, avoid contact with the A17 heatsink.*

#### Test Instructions

1. The instrument's **Top Cover** must be removed to run many of these tests. (Refer to the table on the foldout in **MECHANICAL PROCEDURES** to locate instructions.)

---

**POWER SUPPLY SECTION**

---

2. Testing in this section is divided into two categories: **A17 Module** failures, including **Attenuator Drivers**, **Heterodyne Switch Control**, and **Reverse Power Protection Control** and **Power Supply** failures.
3. **A17 Module**: If you were directed here because of a drivers failure detected while testing the **A14**, **A16** or **A19** modules, or if the **Instrument Level Self Test** indicated an **A17** failure, turn to page **3B-4** to begin troubleshooting.
4. **Power Supply**: If you are here because of an apparent **Power Supply** failure, turn to the next page to begin troubleshooting.

---

**POWER SUPPLY SECTION**

---

**3B-2. INTRODUCTION**

The first step in troubleshooting a Power Supply Section failure is to isolate the defective module or cable.

**Troubleshooting Instructions**

1. There are two foldouts located at the end of this section. The first foldout, **Figure 3B-100**, is used for troubleshooting Power Supply failures and should be pulled out now.
2. Find **POWER SUPPLY DIAGNOSTICS** on the foldout.
3. The Task Sequence Diagrams, shown under **POWER SUPPLY DIAGNOSTICS** are separated into two checks: **1. A18 RECTIFIERS/FILTERS CHECK** and **2. A17 REGULATORS CHECK**.
4. Use the Task Sequence Diagrams to guide you through the verification process. Each Task Arrow shown in a diagram indicates a task title and a task number. The tasks are numbered according to the order in which they are arranged in this section. Turn to the task indicated and complete the procedure.
5. After completing the procedure, return to the Task Sequence Diagram on the foldout and determine the next task to be performed.
6. Begin now by performing the first task shown under **1. A18 RECTIFIERS/FILTERS CHECK**.

**NOTE**

*The **POWER SUPPLY I/O SIGNALS DIAGRAM** shows all parts which these modules depend on for operation.*

---

## A17 INPUTS VERIFICATION

---

### 3B-3. INTRODUCTION

The first step in troubleshooting failures indicated for the **Attenuator Drivers**, **Heterodyne Switch Control** or **Reverse Power Protection Control** portions of the **A17 Module**, is to check each control signal into this module.

#### A17 Inputs Verification Instructions

1. The last page in this section is a foldout, **Figure 3B-200**. It is used for troubleshooting the drivers portion of **A17** and should be pulled out now.
2. Find **A17 INPUTS VERIFICATION** on the foldout.
3. Use the Task Sequence Diagrams shown under **A17 INPUTS VERIFICATION** to direct you through the verification process. Each Task Arrow shown in a diagram indicates a task number and task title. The tasks are numbered according to the order in which they are arranged in this section. Turn to the task indicated and complete the procedure.
4. After completing the procedure, return to the Task Sequence Diagram on the foldout and determine the next task to be performed.
5. Begin now by performing the first task shown on the diagram.

#### COMMENT

*You will find the **A17 MODULE DIAGNOSTICS** procedures at the end of this section following the **POWER SUPPLY DIAGNOSTICS** procedures.*

#### NOTE

*The **A17 MODULE I/O SIGNALS DIAGRAM** shows all parts on which the drivers portion of this module depends for operation.*

---

---

**A17 & A18 MODULE SUBSTITUTION**

---

PS.01

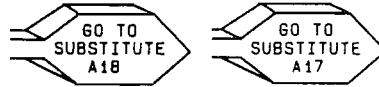
**3B-4. INTRODUCTION**

Substitution of a known good module is used to further test a suspect module.

**A17 & A18 Substitution Instructions**

1. Find **A17 & A18 MODULE SUBSTITUTION** on the foldout.
2. Use the Task Sequence Diagram, shown under **A17 & A18 MODULE SUBSTITUTION**, to direct you through the substitution process. Each Task Arrow shown in the diagram indicates a task title and task number. The tasks are numbered according to the order in which they are arranged in this section. Turn to the task indicated and complete the procedure.
3. After completing the procedure, return to the Task Sequence Diagram on the foldout and determine the next task to be performed.
4. Begin now by performing the first task shown on the diagram for the module you have been directed to substitute.

---

**POWER SUPPLY DIAGNOSTICS**

---

Type:	Voltage Measurements	PS.02
Run time:	1 min.	
Set-up time:	2 min.	

External DC Voltmeter is used to check power supply levels at A17TP1 through 5.

**Run Test**

1. Connect instrument's power plug to a known good power source.
2. Switch **POWER** to ON (recessed position).
3. Connect external DC voltmeter ground lead to instrument's chassis.
4. Measure Power Supply output voltage levels on A17 Module at test points TP1 through 5. (See A17 & A18 MODULES CABLE CONNECTION LOCATOR on foldout to locate test points on A17.) Voltages should be within approximately 1% of those shown in chart on foldout.
5. The tuning screws located next to A17TP1 through 5, can be used to fine tune voltage levels which are >1% high or low.

**COMMENT**

*The voltages measured at A17TP1 through 5 are being fed back from sense points on the A5 Assembly. A correct measurement verifies the presence of the voltage on the A5 Distribution Assembly.*

6. Record test results.
7. Return to foldout:
  - Determine next task by comparing test results to conditions shown in each

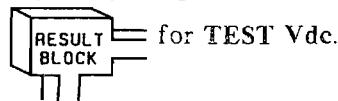

**POWER SUPPLY DIAGNOSTICS**

Type:	Fuse Check	
Run time:	4	
Set-up time:	2 min.	

External DC voltmeter is used to test fuses and rectifier output levels.

1. Remove A18 Module's Top Cover located in right-rear corner of instrument (one screw).
2. Connect power to instrument and switch **POWER** to **ON** (recessed position).
3. Measure voltage levels:
  - Use external DC voltmeter to measure voltage levels, with respect to ground, at fuses A18F1 through 5.
  - Leave fuses in instrument and measure voltage levels at both ends of each fuse holder for F1 through 5.
  - Voltage levels should be within ranges shown in following chart and should read the same at both ends of each fuse.

Fuse Voltages, Vdc				
F1	F2	F3	F4	F5
+15 to +30	-30 to -20	+8 to +13	-13 to -8	+60 to +80

- If all fuse holders measured good at both ends, proceed directly to step 5.
- If any fuse holders measured bad at both ends, proceed directly to step 5, otherwise continue testing.

CAUTION

*Disconnect line power to instrument when removing or replacing fuses.*



---

**POWER SUPPLY DIAGNOSTICS**

---

4. Replace blown fuses:
- ⊗ Use plastic Fuse Puller, from On-Site Service Kit, to remove fuses.

**NOTE**

*Use side-notched end of Fuse Puller to hook fuse and pull it from instrument. Use end-notched end of Fuse Puller to place fuses in fuse holders or to pick up fuses dropped into instrument.*

- ⊗ Replace blown fuses with a good fuse of proper rating from the On-Site Service Kit. (Fuse ratings are shown on Top View Diagram on inside of instrument's Top Cover at each fuse location.)
  - ⊗ Reconnect power to instrument, switch **POWER** to **ON** position and repeat procedure beginning at step 3.
5. Record test results.

**COMMENT**

*If this test has directed you to replace a blown fuse, and if as a result of changing the fuse all levels now measure good, do not return to the foldout. Instead, return to the **INSTRUMENT LEVEL DIAGNOSTICS** section and rerun the **ILST**.*

6. Return to foldout:
- ⊗ Determine next task by comparing test results to conditions shown in each

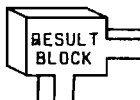

for **TEST FUSES**.

---

**POWER SUPPLY DIAGNOSTICS**

---

Type:	I/O Signals Check	PS.04
Run time:	2 min.	
Set-up time:	1 min.	

External DC voltmeter and ohmmeter are used to check signal levels at A17J1.

**Run Test**

1. Disconnect line power to instrument.
  2. Check Power Switch:
    - Connect one test lead of ohmmeter to GND (A4TP2). (See A17 & A18 MODULES CABLE CONNECTION LOCATOR on foldout.)
    - Connect other test lead to Power Switch control line (A17J1 pin 5). (See A17 & A18 MODULES CABLE CONNECTION LOCATOR on the foldout to locate A17J1.) Figure 3B-1. shows signal locations for A17J1.
    - Switch **POWER** to ON (recessed position). Resistance should measure between 0 and 10 ohms.
    - Switch **POWER** to Standby, resistance should be greater than 500 ohms.
    - If switch line is not responding as described above proceed directly to step 6, otherwise continue testing.
  3. Disconnect ohmmeter from A17J1 and reconnect power to instrument.
  4. Switch **POWER** to ON position.
  5. Measure voltage levels:
    - Connect voltmeter's ground lead to GND (A4TP2).
    - Measure DC voltages at connector A17J1 on solder-side of A17 Module. Voltage level ranges and locations are shown in Figure 3B-1.
-

**POWER SUPPLY DIAGNOSTICS**

---

**Figure 3B-1. Connector A17J1 Signal Locator  
(Solder-Side View)**

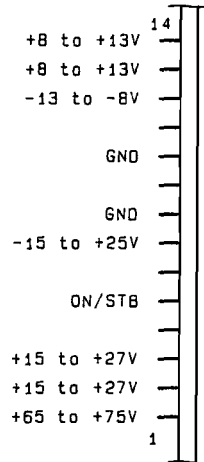

6. Record test results.
7. Return to foldout:
  - Determine next task by comparing test results to conditions shown in each

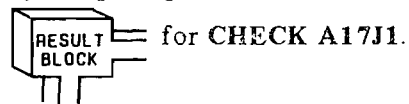

**POWER SUPPLY DIAGNOSTICS**

Type:	Cable Check	PS.05
Run time:	2 min.	
Set-up time:	30 sec.	

Cable **W13** is tested by checking continuity between cable ends and **A17J1**.

**Run Test**

1. Remove power from instrument and disconnect cable **W13** from **A18** Module at **A18J3**.
2. Check continuity through each suspect line by connecting test leads from ohmmeter to each end of **W13**.
  - Connect one test probe to **A17J1** pin connection on solder-side of **A17** Module.
  - Insert the other probe into end of cable **W13**. Select socket with same number as **A17J1** pin connection. (See **Figure 3B-2** to determine pin 1 location.)

**Figure 3B-2. Cable W13 Connection Locator**

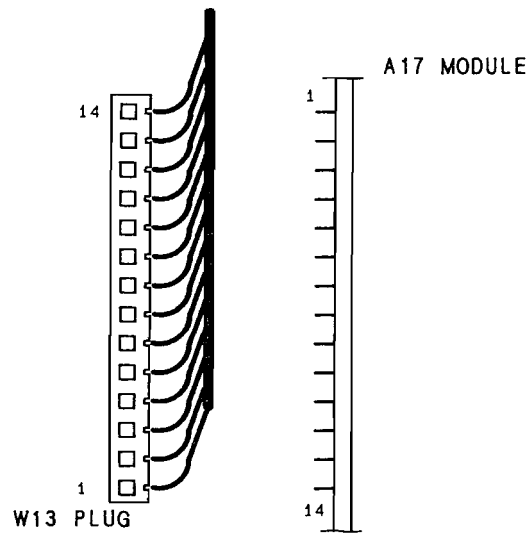

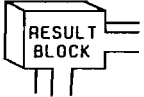
3. Record test results.
4. Return to foldout:
  - Determine next task by comparing test results to conditions shown in each  for **TEST CABLE W13**.

---

**POWER SUPPLY DIAGNOSTICS**

---

Type:	Power Switch Test	PS.06
Run time:	1 min.	
Set-up time:	6 min.	

**Run Test**

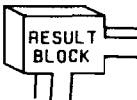
1. Check Power Switch:
  - Open Front Panel. (Refer to table on foldout in **MECHANICAL PROCEDURES** to locate opening instructions.)
  - Check resistance between Power Switch output, on **A1 Module** at **A1A1 J1** pin **30**, and ground. Resistance should measure less than **2 ohms** in **ON** (recessed) position and greater than **500 ohms** in **Standby** position.
  - If switch responds as described, proceed to step 2, otherwise continue testing.
  - If switch does not respond as described, disconnect cable **W15** from **A1 Module** at **A1A1 J1** and retest switch. (Refer to table on foldout in **MECHANICAL PROCEDURES** to locate **A1 Module** removal information.)
  - If switch still does not respond correctly, proceed to step 3, otherwise reconnect **W15** to **A1** and continue testing.
2. Check switch path:
  - Remove right side cover from instrument. (Refer to table on foldout in **MECHANICAL PROCEDURES** for removal information.)
  - Disconnect cable **W10** from **A17 Module** at **A17J2**.
  - Measure resistance at pin **34** of **W10P2**. (Resistance should measure the same as in step 1.)
3. Record test results.
4. Return to foldout:
  - Determine next task by comparing test results to conditions shown in each  for **TEST SWITCH**.

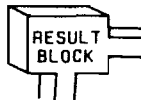

**POWER SUPPLY DIAGNOSTICS**

Type:	Voltage Check	
Run time:	2 min.	
Set-up time:	2 min.	

External DC voltmeter is used to test rectifier output levels with A18 Module isolated from A17 Module.

Run Test

1. Switch instrument to Standby and disconnect line power from instrument.
2. Disconnect cable W13 from A18 Module at A18J3 (see A17 & A18 MODULE CABLE CONNECTION LOCATOR on foldout for A18J3 location).
  - Pull straight up on W13 to disconnect it from A18J3.
3. Reconnect power to instrument.
4. Measure voltage levels:
  - Use external DC voltmeter to measure voltage levels, with respect to ground, at fuses A18F1 through 5.
  - Leave fuses in instrument and measure voltage levels at both ends of each fuse holder for F1 through 5.
  - Voltage levels should be within ranges shown in following chart and should read the same at both ends of each fuse.

Fuse Voltages, Vdc				
F1	F2	F3	F4	F5
+15 to +30	-30 to -20	+8 to +13	-13 to -8	+60 to +80

- If all fuse holders measured good at both ends, proceed directly to step 6.
- If any fuse holders measured bad at both ends, proceed directly to step 6, otherwise continue testing.

---

**POWER SUPPLY DIAGNOSTICS**

---

CAUTION

*Disconnect line power to instrument when removing or replacing fuses.*

5. Replace blown fuses:
  - Use plastic Fuse Puller, from On-Site Service Kit, to remove fuses.

**NOTE**

*Use side-notched end of Fuse Puller to hook fuse and pull it from instrument. Use end-notched end of Fuse Puller to place fuses in fuse holders or to pick up fuses dropped into instrument.*

- Replace blown fuses with a good fuse of proper rating from the On-Site Service Kit. (Fuse ratings are shown on Top View Diagram on inside of instrument's Top Cover at each fuse location.)
  - Reconnect power to instrument, switch **POWER** to **ON** position and repeat procedure beginning at step 3.
6. Record test results.
  7. Return to foldout:
    - Determine next task by comparing test results to conditions shown in each

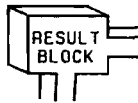

for ISOLATE A18.

---

**POWER SUPPLY DIAGNOSTICS**

---

Type:	4; AC Voltage Measurements	PS.08
Run time:	2 min.	
Set-up time:	7 min.	

External AC voltmeter is used to check voltages to A18 Module from Transformer, T1.

**Run Test**

1. Switch instrument to Standby and disconnect line power from instrument.

**WARNING**

*Removing rear bottom cover exposes Filter cap screw heads. Voltage potentials are still present at these screws even when power has been removed.*

2. Remove instrument's rear bottom cover. (Refer to table on foldout in **MECHANICAL PROCEDURES** for removal information).

**WARNING**

*Power Transformer T1 should be isolated from AC voltmeter. We recommend you use a portable voltmeter that is not connected to the same power main as the instrument.*

3. Measure voltage levels:
  - Connect voltmeter's ground lead to instrument's chassis.
  - Reconnect line power to instrument.
  - Measure AC voltages at A18J1 (see A17 & A18 MODULE CABLE CONNECTION LOCATOR on the foldout to locate A18J1). See Figure 3B-3 for voltage levels.



**POWER SUPPLY DIAGNOSTICS**

**Figure 3B-3 Connector A18J1 Signal Locator**  
(Solder-Side of Board)

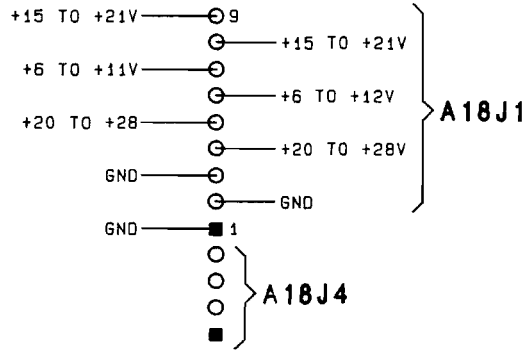

4. Record test results.
5. Return to foldout:
  - ⊗ Determine next task by comparing test results to conditions shown in each

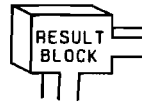

for TEST AC POWER.

---

**POWER SUPPLY DIAGNOSTICS**



---

Type:	Supply Lines Test	PS.09
Run time:	1 min.	
Set-up time:	6 min.	

This test uses **Power Supply Test Connector** from **On-Site Service Kit** to isolate **Power Supply Section** from rest of instrument.

**Run Test**

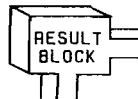
1. Switch **POWER** to Standby and disconnect power plug.
2. Remove right side cover from instrument. (Refer to table on foldout in **MECHANICAL PROCEDURES** for removal information).
3. Disconnect cable **W10** from **A17 Module** at **A17J2**. (See **A17 & A18 MODULES CABLE CONNECTION LOCATOR** for **A17J2** location.)
4. Connect **Power Supply Test Connector** (HP 08642-80053) and 50 pin ribbon cable, from **On-Site Service Kit**, to **A17 Module** at **A17J2**.
5. Connect line power to instrument.
6. Turn **Power Supply** on:
  - Connect black alligator clip and retractable clip probe to black test lead from **On-Site Service Kit**.
  - Connect alligator clip to **GND (A4TP2)**. (See **A17 & A18 MODULES CABLE CONNECTION LOCATOR** on foldout for **GND** location.)
  - Connect retractable clip probe to test connector at **TP1**.
7. Measure voltage levels at test points **A17TP1** through **5**. (See **A17 & A18 MODULES CABLE CONNECTION LOCATOR** on foldout for **A17TP1** through **5** locations.) Voltage levels should be within approximately 1% of those shown in chart on foldout.
8. Remove test connector:
  - Disconnect ground from **TP1** on test connector.
  - Disconnect **Power Supply Test Connector** and ribbon cable from **A17 Module**.
  - Reconnect cable **W10** to **A17 Module**.
9. Record test results.
10. Return to foldout:
  - Determine next task by comparing test results to conditions shown in each **RESULT BLOCK** for **ISOLATE POWER SUPPLY**.



---

**POWER SUPPLY DIAGNOSTICS**

---

Type:	Distribution Test	PS.10
Run time:	1 min. per set-up	
Set-up time:	Up to 15 min.	

This test determines if **Power Supply Section** failure is due to over loading by **Control** or **RF Sections**.

**Run Test**

1. Switch **POWER** to Standby.

CAUTION

*Be sure to use adequate Electrostatic Discharge (ESD) precautions when handling A3 and A4 Modules.*

2. Remove **A3** and **A4** modules from instrument (see Top View Diagram on inside Top Cover to locate **A3** and **A4**).
3. Switch **POWER** to ON.
4. Measure voltage levels at test points **A17TP1** through **5**.
  - If all voltage levels measure within 1% of those shown in chart on foldout, proceed directly to step **10**, otherwise continue testing.
5. Switch **POWER** to Standby.
6. Beginning at left side of **A5 Distribution Assembly**, disconnect ribbon cable **W1** from **A5 Assembly** at **A5J1**. (See **A17 & A18 MODULES CABLE CONNECTIONS LOCATOR** on foldout to locate **J1** on **A5 Assembly**.) Refer to table on foldout in **MECHANICAL PROCEDURES** for information on disconnecting cables from **A5**.
7. Switch **POWER** to ON.
8. Measure voltage levels at test points **A17TP1** through **5**.
9. Repeat steps **5** through **8** for each ribbon cable connected to **A5** (except **W10**) or until **Power Supply** unloads.
10. Record test results. (If **Power Supply** unloads, suspect last cable and module disconnected from **A5** just before unloading occurred.)
11. Return to foldout:
  - Determine next task by comparing test results to condi-

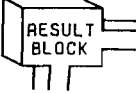
tions shown in each  for **IDENTIFY CAUSE**.

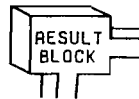

---

**POWER SUPPLY DIAGNOSTICS**

---

Type:	Module Substitution	PS.11
Run time:	0	
Set-up time:	20 min.	

**Connect Substitute Module**

1. Refer to table shown on foldout in **MECHANICAL PROCEDURES** to locate removal and replacement procedures for module you have been directed to substitute.
2. Return to foldout.

**POWER SUPPLY DIAGNOSTICS**

---

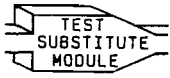
Type:	Substitute Module Test	PS.12
Run time:	1 min.	
Set-up time:	2 min.	

External DC Voltmeter is used to check power supply levels at A17TP1 through 5.

Run Test

1. Connect instrument's line power plug to a known good power source.
2. Switch **POWER** to ON position.
3. Connect external DC voltmeter ground lead to instrument's chassis.
4. Measure Power Supply output voltage levels on A17 Module at test points TP1 through 5. (See A17 & A18 MODULES CABLE CONNECTION LOCATOR on foldout for test point locations and voltage levels.) Voltages should be within approximately 1% of those shown in chart.
5. The tuning screws located next to A17TP1 through 5, can be used to fine tune voltage levels which are slightly >1% high or low.

**COMMENT**

*The voltages measured at A17TP1 through 5 are being fed back from sense points on the A5 Assembly. A correct measurement verifies the presence of the voltage on the A5 Distribution Assembly.*

6. Record test results.
7. Return to foldout:
  - Determine next task by comparing test results to conditions shown in each **RESULT BLOCK** for **TEST SUBMODULE**.

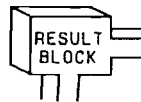

---

**POWER SUPPLY DIAGNOSTICS**

---

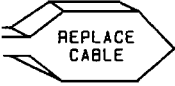
Type:	Cable Substitution	PS.13
Run time:	5 min.	
Set-up time:	1 min.	

1. Testing has shown cable W13 to be suspect (refer to **REPLACEABLE PARTS**, in HP 8642A/B Operating and Service Manual, for information to order a replacement cable).
2. Rerun **INSTRUMENT LEVEL DIAGNOSTICS (ILD)** to confirm repair.

**A17 MODULE DIAGNOSTICS**

---

Type:	Control Signals Test	<b>A17.01</b>
Run time:	1 min.	
Set-up time:	0	

**Run Test**

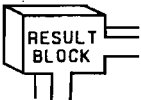
1. **INSTR PRESET** **SHIFT**  
 (Hold shift key until "100.000000MZ -140.0DM" appears, to override 20 second reset test.)
2. **SHIFT** **SPCL** **3** **3** **6** **2** **HZ**
3. When "DIAG DONE HIT MSSG .V1" appears:
  - Use **MSSG** to scroll through messages.
  - Record error code(s) displayed for **A17**. If "TEST 1 OF A17 (PASSED or FAILED)" is not displayed, rerun test.
4. Return to foldout:
  - Determine next task by comparing test results to conditions shown in each  for TEST A17 CONTROL BITS.

---

**A17 MODULE DIAGNOSTICS**

---

Type:	3; Bit Transmission	A17.02
Run time:	12 min.	
Set-up time:	2 min.	

Internal Voltmeter (VM) is used to measure TTL level changes transmitted to A17 Module on Attenuator Driver control lines.

**COMMENT**

*If any control line level measures bad, it is not necessary to test remaining lines; proceed directly to step 14.*

**Run Test**

1. Switch **POWER** to Standby:
  - Remove right side cover from instrument (refer to table on foldout in **MECHANICAL PROCEDURES** for information).
  - Disconnect cable W9 from A17 Module at A17J3.
  - Plug end of cable W9 into 50 pin test connector, from On-Site Service Kit.

**NOTE**

*Find arrowhead on test connector and align with arrowhead on cable plug W9P2.*

**CAUTION**

*To prevent damage to the Control Section, do not permit the exposed pins on the test connector to short circuit.*

2. Connect VM probe:
  - Connect red alligator clip and retractable hook probe to red test lead provided in On-Site Service Kit. Connect alligator clip to VM IN (A4TP1). (See A17 MODULE CABLE CONNECTION LOCATOR on foldout for VM IN location.)
3. Switch **POWER** to ON.  
 (Hold shift key until "100.000000MZ -140.0DM" appears, to override 20 second reset test.)



**A17 MODULE DIAGNOSTICS**

---

**Attenuator Driver Control Lines**

**Check High State**

4.        
(To specify high state.)
5. Enter **Bit Select Keys**, as indicated in **Table 3B-1**. **W9P2** Control Bits, for Control Line to be tested.
6. Connect **VM** probe to Control Line at Pin Number indicated in **Table 3B-1**. (See **Figure 3B-4**, Cable Plug **W9P2** Signal Locator.)

**Table 3B-1. W9P2 Control Bits**

Test Order	Control Line	Bit Select Keys (Steps 5 and 10)	Pin Number (Step 6)
1	ATN BAND TRIG	<input type="button" value="5"/> <input type="button" value="9"/> <input type="button" value="HZ"/>	34
2	ATN LEVEL TRIG	<input type="button" value="6"/> <input type="button" value="2"/> <input type="button" value="HZ"/>	22
3	ATN 0	<input type="button" value="6"/> <input type="button" value="4"/> <input type="button" value="HZ"/>	29
4	ATN 1	<input type="button" value="6"/> <input type="button" value="5"/> <input type="button" value="HZ"/>	31
5	ATN 2	<input type="button" value="6"/> <input type="button" value="6"/> <input type="button" value="HZ"/>	25
6	ATN 3	<input type="button" value="6"/> <input type="button" value="7"/> <input type="button" value="HZ"/>	26
7	ATN 4	<input type="button" value="6"/> <input type="button" value="8"/> <input type="button" value="HZ"/>	14
8	ATN 5	<input type="button" value="6"/> <input type="button" value="9"/> <input type="button" value="HZ"/>	2
9	ATN 6	<input type="button" value="7"/> <input type="button" value="0"/> <input type="button" value="HZ"/>	9

---

**A17 MODULE DIAGNOSTICS**

**Figure 3B-4. Cable Plug W9P2 Signal Locator**

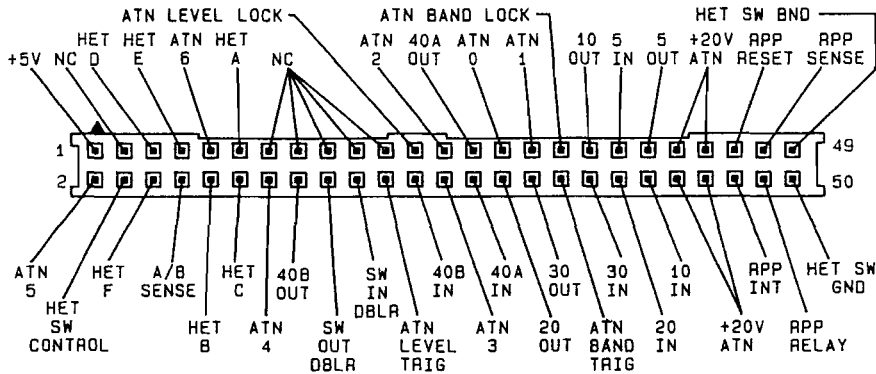

7.    (To enable voltmeter.)
8. Voltage should read approximately +2.5 to +5.5 Vdc.   to repeat measurement.)

**Check Low State**

9.       (To specify low state.)
10. Enter **Bit Select Keys**, as indicated in **Table 3B-1. W9P2 Control Bits**, for same **Control Line**.
11.    (To enable voltmeter.)
12. Voltage should read approximately -0.5 to +1.5 Vdc.   to repeat measurement.)
13. Repeat procedure for each **Control Line** shown in **Table 3B-1**.
14. Record test results.
15. Return to foldout:
  - Determine next task by comparing test results to conditions shown in each **TEST ATN CONTROL BITS**.

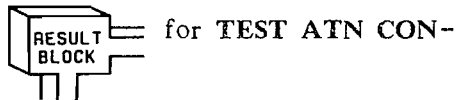

---

**A17 MODULE DIAGNOSTICS**

---

Type:	3; Bit Transmission	
Run time:	2 min.	
Set-up time:	2 min.	

Internal Voltmeter (VM) is used to measure TTL level changes transmitted to A17 on **Reverse Power Reset** line.

**Run Test**

- Switch **[POWER]** to Standby:
  - Remove right side cover from instrument (refer to table on foldout in **MECHANICAL PROCEDURES** for removal information).
  - Disconnect cable **W9** from module at **A17J3**.
  - Plug end of **W9** into **50** pin test connector, from On-Site Service Kit.

**NOTE**

*Find arrowhead on test connector and align with arrowhead on cable plug **W9P2**.*

CAUTION

*Do not permit the exposed pins on the test connector to short circuit.*

- Connect VM probe:
  - Connect red alligator clip and retractable hook probe to red test lead provided in On-Site Service Kit.
  - Connect alligator clip to VM IN (A4TP1). (See **A17 MODULE CABLE CONNECTION LOCATOR** on foldout for VM IN location.)
- Switch **[POWER]** on.  
**[INSTR PRESET]** **[SHIFT]**  
 (Hold shift key until "100.000000MZ -140.0DM" appears, to override 20 second reset test.

**Reverse Power Protection Reset****Check High State**

- [SHIFT]** **[SPCL]** **[3]** **[6]** **[0]** **[1]**  
 (To specify high state.)
-

**A17 MODULE DIAGNOSTICS**

5. **6 3 HZ**  
(To select bit.)
6. Connect VM probe to test connector line **RPP Reset** (pin 45). (See Figure 3B-6. Cable Plug W9P2 Signal Locator.)

**Figure 3B-6. Cable Plug W9P2 Signal Locator**

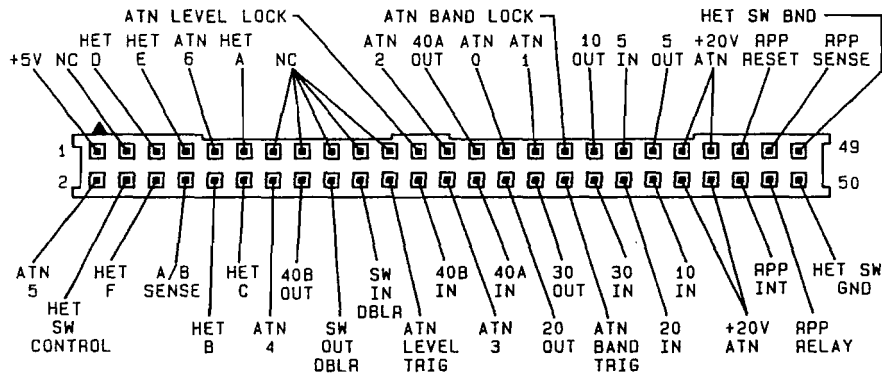

7. **2 5 HZ**  
(To enable voltmeter.)
8. Voltage should read approximately **+2.5 to +5.5 Vdc.**  
**5 HZ** to repeat measurement.)

**Check Low State**

9. **SHIFT SPCL 3 6 0 2**  
(To specify low state.)
10. **6 3 HZ**  
(To select bit.)
11. **2 5 HZ**  
(To enable voltmeter.)
12. Voltage should read approximately **-0.5 to +1.5 Vdc.**  
**5 HZ** to repeat measurement.)
13. Record test results.
14. Return to foldout:
  - ⊙ Determine next task by comparing test results to conditions shown in each **RESULT BLOCK** for **TEST RPP RESET BIT.**

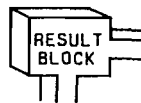

---

**A17 MODULE DIAGNOSTICS**

---

Type:	3; Bit Transmission	<b>A17.04</b>
Run time:	2 min.	
Set-up time:	2 min.	

Internal Voltmeter (VM) is used to measure TTL level changes transmitted to **A17** on Heterodyne Switch control line.

**Run Test**

- Switch **POWER** to Standby:
  - Remove right side cover from instrument. (Refer to table on foldout in **MECHANICAL PROCEDURES** for removal information).
  - Disconnect cable **W9** from module at **A17J3**.
  - Plug end of **W9** into 50 pin test connector, from On-Site Service Kit.

**NOTE**

*Find arrowhead on test connector and align with arrowhead on cable plug **W9P2**.*

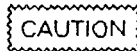

*To prevent damage to the Control Section, do not permit the exposed pins on the test connector to short circuit.*

- Connect **VM** probe:
  - Connect red alligator clip and retractable hook probe to red test lead provided in On-Site Service Kit.
  - Connect alligator clip to **VM IN (A4TP1)**. (See **A17 MODULE CABLE CONNECTION LOCATOR** on foldout for **VM IN** location.)
- Turn instrument on.
 

**INSTR PRESET** **SHIFT**

 (Hold shift key until "100.000000MZ -140.0DM" appears, to override 20 second reset test.)

**Heterodyne Switch Control Line****Check High State**

- SHIFT** **SPCL** **3** **6** **0** **1**  
(To specify high state.)
-

**A17 MODULE DIAGNOSTICS**

5.    (To select bit.)
6. Connect VM probe to test connector line HET SW CONTROL (pin 4). (See Figure 3B-5. Cable Plug W9P2 Signal Locator.)

**Figure 3B-5. Cable Plug W9P2 Signal Locator**

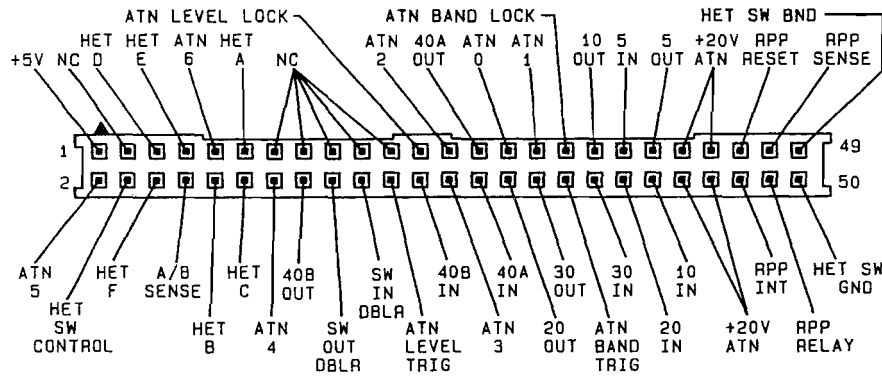

7.    (To enable voltmeter.)
8. Voltage should read approximately +2.5 to +5.5 Vdc.   to repeat measurement.)

**Check Low State**

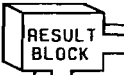
9.       (To specify low state.)
10.    (To select bit.)
11.    (To enable voltmeter.)
12. Voltage should read approximately -0.5 to +1.5 Vdc.   to repeat measurement.)
13. Record test results.
14. Return to foldout:
  - Determine next task by comparing test results to conditions shown in each  for TEST HET CONTROL BIT.

---

**A17 MODULE DIAGNOSTICS**

---

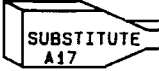
Type:	Module Substitution	<b>A17.05</b>
Run time:	0	
Set-up time:	22 min.	

**Connect Substitute Module**

1. Refer to table shown on foldout in **MECHANICAL PROCEDURES** to locate **A17 Module** removal and replacement procedures.
2. Return to **A17 MODULE SUBSTITUTION** on foldout.

**A17 MODULE DIAGNOSTICS**

Type:	Substitute Module Test	
Run time:	Conditional	
Set-up time:	Conditional	

The **A17** failure conditions for arriving at this task are described below. Follow the procedure for the **condition** which best fits your module.

- Condition 1: **A17 INPUTS VERIFICATION** indicated **A17** failure.
- Condition 2: **Instrument Level Self Test** indicated **A17** failure.
- Condition 3: **Module Level Diagnostics (MLD)** for **A14**, **A16**, or **A19** indicated **A17** failure.

Condition 1

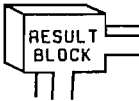
1.    
 (Hold shift key until "100.000000MZ -140.0DM" appears, to override 20 second reset test.)
2.
3. When "DIAG DONE HIT MSSG .V1" appears:
  - Use  to scroll through messages.
  - Record error code(s) displayed for **A17**. If "TEST 1 OF A17 (PASSED or FAILED)" is not displayed, rerun test.
4. Return to foldout:
  - Determine next task by comparing test results to conditions shown in each  for TEST SUB A17.

Condition 2

1.    
 (Hold shift key until "100.000000MZ -140.0DM" appears, to override 20 second reset test.)
2.



---

**A17 MODULE DIAGNOSTICS**

---

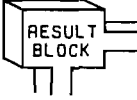
3. When "WAITING FOR SET-UP 1 .V24" appears:
  - Connect BNC Tee connector, from On-Site Service Kit, to "FM/ΦM INPUT" (see ILD foldout for set-up diagram).
  - Connect a coax cable from Tee connector to "MOD OUTPUT".
  - Connect a coax cable from Tee to "AM/PULSE INPUT".
  - HZ to continue test.
4. When "DIAG DONE HIT MSSGS .VI" appears:
  - Use  MSSG to scroll through messages.
  - Record any error code(s) displayed for A17.
5. Return to foldout:
  - Determine next task by comparing test results to conditions shown in each  for TEST SUB A17.

**Condition 3**

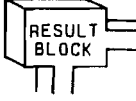
1. Rerun test which indicated A17 failure.
2. Record test result.
3. Return to foldout:
  - Determine next task by comparing test results to conditions shown in each  for TEST SUB A17.

---

**A17 & A18 THEORY OF OPERATION**

---

**3B-5. A17 REGULATORS/ATTENUATOR DRIVERS  
MODULE  
A18 RECTIFIER/FILTER MODULE****COMMENT**

*It is not essential to understand the internal operation of a module to make an on-site repair.*

**Power Supply**

The HP 8642 requires five regulated power supplies for operation: **+50, +15, +5, -5, and -15 Vdc**. The **A18 Module** full-wave rectifies the outputs from the Power Transformer **T1**. Each supply line is low-pass filtered and fused on the **A18 Module**. The **+15** and **-15** volt lines are switched open when the **POWER** key on the Front Panel is switched to the **Standby** position. The rectifiers and filters remain active whenever line power is connected to the instrument.

Series-pass type regulators on the **A17 Module** provide level regulation for each supply line. Bias and reference voltages for each regulator are provided by the **+15** and **-15** volt supplies. The output level of each regulator is sensed on the **A5 Assembly** and feedback to control the series-pass element. This requires the supply signal to be present on the **A5 Distribution Assembly** for the regulator to operate. Each regulator is provided with over-voltage protection at its output.

**A17 Drivers**

The drivers portion of the **A17 Module** provides the proper drive signals to control the attenuators and RF switches in the instrument. It also drives the relay for the reverse power protection circuit. The **A17 Module** senses which attenuator module it is driving and provides continuous state signals to the **A16 Module** and pulsed, drive signals to the **A16 (option 003)** and **A19** modules.

See the **A17 and A18 MODULES SIMPLIFIED BLOCK DIAGRAMS** for further understanding of the internal operation of these modules.

A18 MODULE SIMPLIFIED BLOCK DIAGRAM

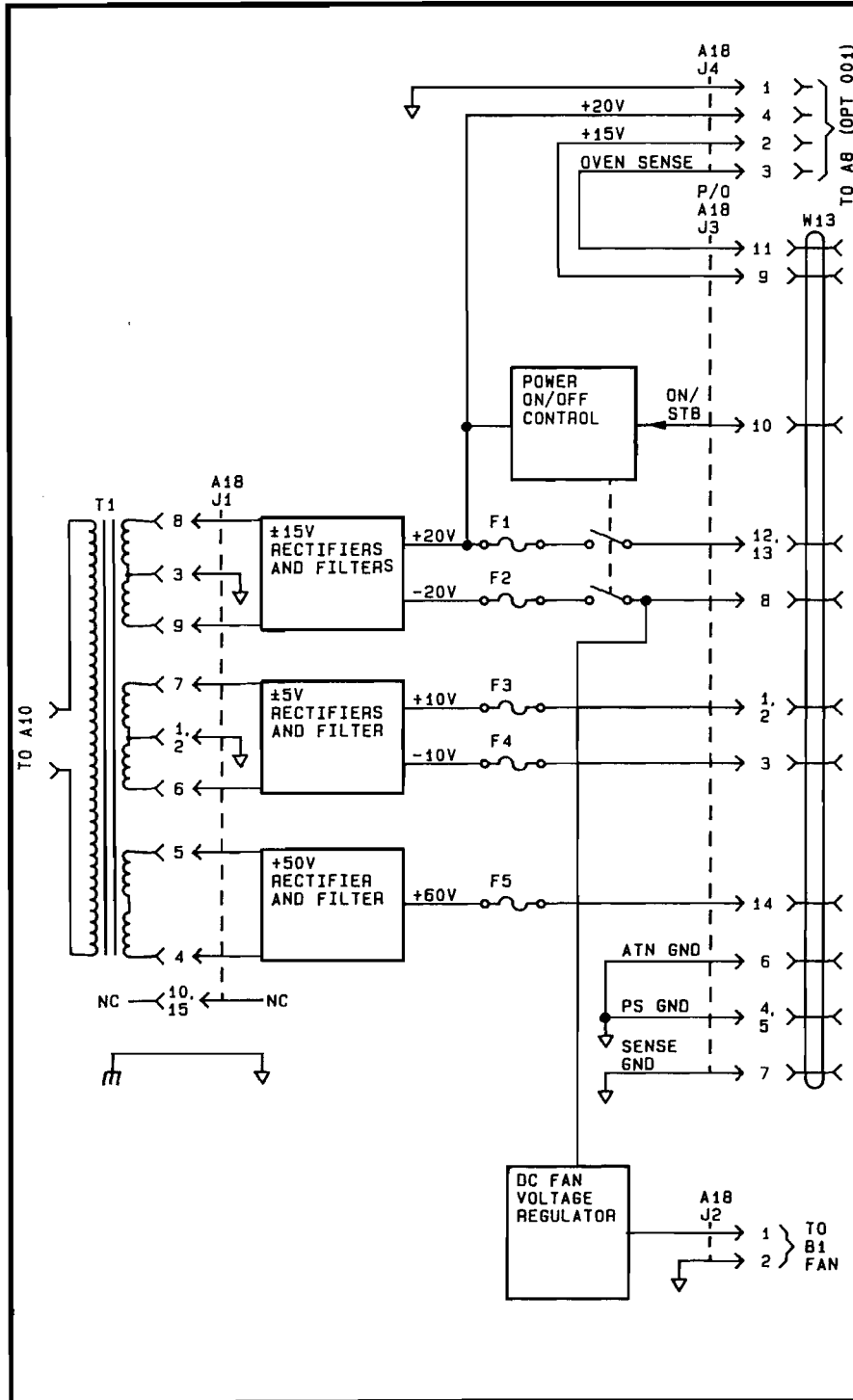

---

**CONTROL SECTION DIAGNOSTICS**

---

**3C-1. INTRODUCTION**

The **MODULE LEVEL DIAGNOSTICS (MLD)** contained in this section are used to further interrogate the **Control Section Modules: A1 Keyboard/LCD Display Module, A3 Processor/Memory Module, and A4 Latch Module.** The objective is to isolate the failure indicated for this section to a module or to a part on which the **Control Section** depends for operation.

**NOTE**

*At this level of testing, it is assumed that the Power Supply Section is operational. If there is any doubt, turn to the POWER SUPPLY SECTION to begin troubleshooting.*

**Test Instructions**

1. The instrument's **Top Cover** must be removed to run many of these tests. (Refer to the table shown on the foldout in **MECHANICAL PROCEDURES** to locate instructions.)
2. The last page in this group of tests is a foldout and should be pulled out now.
3. Testing in this section is divided into **three** parts, one part for each of the three **Control Section** modules: **A4, A3, A1.**
4. Begin the **Control Section Diagnostics** by reading the next page.

---

## A4 MODULE SUBSTITUTION

---

### 3C-2. INTRODUCTION

The first step in isolating a Control Section failure is to substitute in a known good **A4 Module** from the On-site Service Kit.

#### A4 Substitution Instructions

1. Find **A4 MODULE SUBSTITUTION** on the foldout.
2. Use the Task Sequence Diagram, shown under **A4 MODULE SUBSTITUTION**, to direct you through the substitution process. Each Task Arrow shown in the diagram indicates a task title and task number. The tasks are numbered according to the order in which they are arranged in this section. Turn to the page indicated and complete the procedure.
3. After completing the procedure, return to the Task Sequence Diagram on the foldout and determine the next task to be performed.
4. Begin now by performing the first task shown on the diagram.

#### NOTE

*The CONTROL SECTION I/O SIGNALS DIAGRAM shows all parts which the control modules depend on for operation.*

---

**A3 MODULE SUBSTITUTION**

---

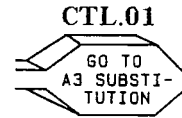
**3C-3. INTRODUCTION**

To isolate a **Control Section** failure to the **A3 Module**, substitute in a known good module from the On-Site Service Kit.

**A3 Substitution Instructions**

1. Find **A3 MODULE SUBSTITUTION** on the foldout.
2. Use the **Task Sequence Diagram**, shown under **A3 MODULE SUBSTITUTION**, to direct you through the substitution process. Each **Task Arrow** shown in the diagram indicates a task title and task number. The tasks are numbered according to the order in which they appear in this section. Turn to the task indicated and complete the procedure.
3. After completing the procedure, return to the **Task Sequence Diagram** on the foldout and determine the next task to be performed.
4. Begin now by performing the first task shown on the diagram.

---

**A1 MODULE SUBSTITUTION**

---

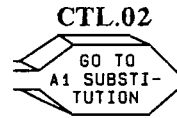
**3C-4. INTRODUCTION**

To isolate a **Control Section** failure to the **A1 Module**, substitute in a known good module from the On-site Service Kit.

**A1 Substitution Instructions**

1. Find **A1 MODULE SUBSTITUTION** on the foldout.
2. Use the Task Sequence Diagram, shown under **A1 MODULE SUBSTITUTION**, to direct you through the substitution process. Each Task Arrow shown in the diagram indicates a task title and task number. The tasks are numbered in the order in which they are arranged in this section. Turn to the task indicated and complete the procedure.
3. After completing the procedure, return to the Task Sequence Diagram on the foldout and determine the next task to be performed.
4. Begin now by performing the first task shown on the diagram.

**CONTROL SECTION DIAGNOSTICS**

<b>Type:</b>	4, Voltage Measurements	<b>CTL.03</b>
<b>Run time:</b>	2 min.	
<b>Set-up time:</b>	0 min.	

External DC voltmeter is used to test power supply levels at A4 Module.

**Run Test**

1. Turn instrument on.
2. Connect external DC voltmeter ground lead to A4 Module at A4TP2 (GND). (See CONTROL SECTION CONNECTOR LOCATOR on foldout to locate ground post.)
3. Measure power supply voltage levels:
  - Connect test probe to A4 Service Test Points (see Figure 3C-1. A4J1 Service Test Point Signal Locator).

**Figure 3C-1. A4J1 Service Test Points Signal Locator**

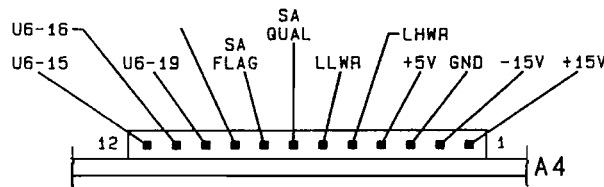

4. Record test results.
5. Return to foldout.
  - Determine next task by comparing test results to conditions shown in each

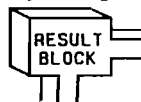

for TEST A4 Vdc.



---

**CONTROL SECTION DIAGNOSTICS**

---

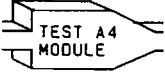
Type:	Module Tests	<b>CTL.04</b>
Run time:	Conditional	
Set-up time:	Conditional	

The Control Section failure conditions for arriving at this task are described below. Follow the procedure for the condition which fits your instrument.

- Condition 1:** Instrument Level Diagnostics (ILD) indicated Control Section failure.
- Condition 2:** Module Level Diagnostics (MLD) for another module indicated Control Section failure.
- Condition 3:** Instrument must be set to a specific operating condition to detect Control Section failure.

**Condition 1**

1.    
(Hold shift key until "100.000000MZ -140.0DM" appears, to override 20 second reset test.
  2.      .
  3. When "WAITING FOR SET-UP 1 .V24" appears:
    - Connect BNC Tee connector, from On-Site Service Kit, to "FM/ΦM INPUT" (see INSTRUMENT LEVEL DIAGNOSTICS foldout for set-up diagram).
    - Connect a coax cable from Tee connector to "MOD OUTPUT".
    - Connect a coax cable from Tee to "AM/PULSE INPUT"
    - to continue test.
  4. When "DIAG DONE HIT MSSGS .VI" appears:
    - Use  to scroll through messages.
    - Record test results.
  5. Return to foldout.
-

---

**CONTROL SECTION DIAGNOSTICS**

---

**Condition 2**

1. Rerun test which indicates Control Section failure.
2. Record test results.
3. Return to foldout.

**Condition 3**

1. Set instrument to operating condition which causes Control Section failure.
2. Record instrument set-up and error message(s).
3. Return to foldout.

---

**CONTROL SECTION DIAGNOSTICS**

---

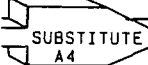
Type:	Module Substitution	CTL.05
Run time:	0	
Set-up time:	2 min.	

**Substitute Module**

1. Switch instrument to Standby.
2. Remove **A4 Module** from instrument. (Refer to table on foldout in **MECHANICAL PROCEDURES** for location of removal information.)
3. Replace **A4 Module** with a known good module from On-Site Service Kit.
4. Turn instrument on.
5. Return to foldout.

**CONTROL SECTION DIAGNOSTICS**

Type:	Module Tests	<b>CTL.06</b>
Run time:	Conditional	
Set-up time:	Conditional	

Test operation of substitute module by repeating test(s) performed on module before substitution.

- Condition 1: Instrument Level Diagnostics (ILD) indicated Control Section failure.
- Condition 2: Module Level Diagnostics (MLD) for another module indicated Control Section failure.
- Condition 3: Instrument must be set to a specific operating condition to detect Control Section failure.

**Condition 1**

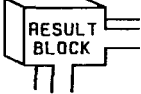
1.  SHIFT  SPCL  3  3  0  HZ.
2. When "WAITING FOR SET-UP 1 .V24" appears:
  - Connect BNC Tee connector, from On-Site Service Kit, to "FM/ΦM INPUT" (see INSTRUMENT LEVEL DIAGNOSTICS foldout for set-up diagram).
  - Connect a coax cable from Tee connector to "MOD OUTPUT".
  - Connect a coax cable from Tee to "AM/PULSE INPUT"
  - HZ to continue test.
3. When "DIAG DONE HIT MSSGS .VI" appears:
  - Use  MSSG to scroll through messages.
  - Record test results.
4. Return to foldout.
  - Determine next task by comparing test results to conditions shown in each  for TEST SUB MODULE.

---

**CONTROL SECTION DIAGNOSTICS**

---

**Condition 2**

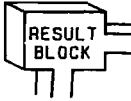
1. Rerun test which indicates **Control Section** failure.
2. Record test results.
3. Return to foldout.
  - Determine next task by comparing test results to conditions shown in each  for **TEST SUB MODULE**.

**Condition 3**

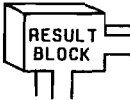
1. Set instrument to operating condition which causes **Control Section** failure.
2. Record instrument set-up and error message(s).
3. Return to foldout:
  - Determine next task by comparing test results to conditions shown in each  for **TEST SUB MODULE**.

**CONTROL SECTION DIAGNOSTICS**

Type:	4; Voltage Measurements	<b>CTL.07</b> 
Run time:	2' min.	
Set-up time:	0 min.	

External DC voltmeter is used to test power supply levels at A3 Module.

**Run Test**

1. Turn instrument on.
2. Connect external DC voltmeter ground lead to A4 Module at A4TP2 (GND). (See CONTROL SECTION CONNECTOR LOCATOR on foldout to locate ground post.)
3. Measure power supply voltage levels:
  - Connect test probe to A3 Service Test Points (see Figure 3C-2. A3J4 Service Test Point Signal Locator).

Figure 3C-2. A3J4 Service Test Point Signal Locator

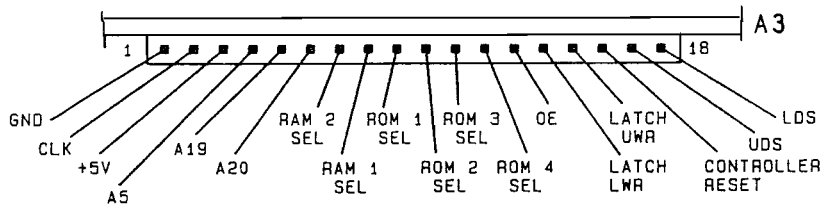

4. Record test results.
5. Return to foldout.
  - Determine next task by comparing test results to conditions shown in each

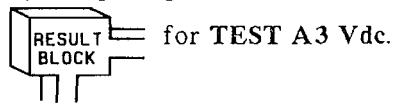

---

**CONTROL SECTION DIAGNOSTICS**

---

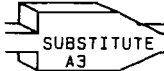
<b>Type:</b>	Module Substitution	<b>CTL.08</b>
<b>Run time:</b>	1 min.	
<b>Set-up time:</b>	3 min.	

In order for the instrument to operate correctly with substitute **A3 Module**, it is necessary to transfer Calibration Data from instrument's **A20 Calibration Module** to substitute **A3 Module**.

#### Substitute Module

1. Switch instrument to **Standby**.
2. Remove **A3 Module** from instrument. (Refer to foldout in **MECHANICAL PROCEDURES** to locate removal information.)
3. Replace **A3 Module** with a known good module from On-Site Service Kit.

#### Down-Load Cal Data

CAUTION

*Use adequate Electrostatic Discharge Techniques when handling the A20 Calibration Module.*

4. Remove **A20 Calibration Module** from **Rear Panel**. (Refer to table on foldout in **MECHANICAL PROCEDURES** to locate removal information.)

CAUTION

*Check that switch S1 on A20 Module is switched up to its "PROTECTED" position.*

*The Calibration Data stored on the A20 Module and in the instrument will be destroyed by misapplied electrical signals.*

---

---

**CONTROL SECTION DIAGNOSTICS**

---

5. Switch instrument to **Standby**.
6. Connect **A20 Module** to **A3 Module** at **A3J3** (see **CONTROL SECTION CONNECTOR LOCATOR** on foldout).
7. Turn instrument on.
8. When "**100.000000 MZ -140.00 DM**" appears:
  - Slide switch on left side of **A3S2** (on **A3 Module**) back toward rear of instrument (see **CONTROL SECTION CONNECTOR LOCATOR** on foldout).
9. **SHIFT** **SPCL** **3** **7** **5** **HZ**
10. When "**TRANSFER VERIFIED .U613**" appears:
  - Slide **A3S2** forward, toward front of instrument to protect **A3 Module's** memory.
11. Switch instrument to **Standby** and remove **A20 Module**.  
**Replace A20 Module on Rear Panel** of instrument.
12. Return to foldout.



---

**CONTROL SECTION DIAGNOSTICS**

---

Type:	4, Voltage Measurements	CTL.09
Run time:	2 min.	
Set-up time:	6 min.	

External DC Voltmeter is used to check power supply levels at inputs to A1 Module.

**Run Test**

1. Turn instrument on.
2. Connect external DC voltmeter ground lead to A4 Module at A4TP2 (GND). (See CONTROL SECTION CONNECTOR LOCATOR on foldout to locate ground post.)

**CAUTION**

*Opening the Front Panel without following the instructions presented in the MECHANICAL PROCEDURES section may cause damage to the Front Panel.*

3. Measure voltage levels at A1A1 J1:
  - Open Front Panel. (Refer to table on foldout in MECHANICAL PROCEDURES to locate Front Panel information).
  - Access signals from solder-side of A1A1 J1. (See CONTROL SECTION CONNECTOR LOCATOR on foldout to locate A1A1 J1.)
  - Voltage levels and locations are shown in Figure 3C-3.

**CONTROL SECTION DIAGNOSTICS**

**Figure 3C-3. Connector A1A1 J1 Signal Locator**

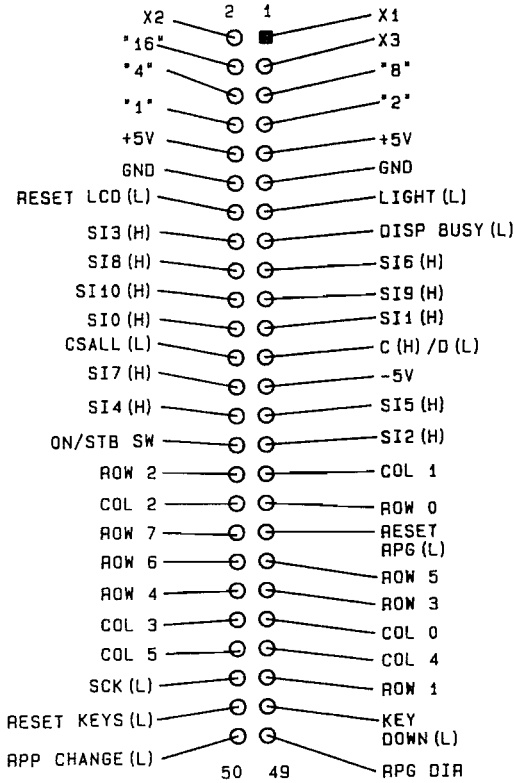

4. Record test results.
5. Return to foldout.
  - Determine next task by comparing test results to conditions shown in each

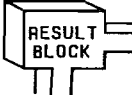
tions shown in each  for TEST A1 Vdc.

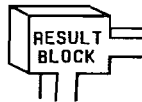

---

**CONTROL SECTION DIAGNOSTICS**

---

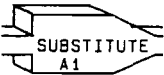
Type:	Module Substitution	CTL.10
Run time:	0	
Set-up time:	10 min.	

**Substitute Module**

1. Switch instrument to **Standby** and disconnect power plug.
2. Remove **A1 Module** from instrument. (Refer to table on foldout in **MECHANICAL PROCEDURES** for location of removal information).
3. Replace module with a known good **A1 Module** from On-Site Service Kit.

**COMMENT**

*To set-up the substitute A1 Module for testing, simply connect cables at A1A1 J1 and A1A1 J3 on substitute module and attach module to front panel with four nuts (1 at each corner).*

4. Return to foldout.

---

**CONTROL SECTION DIAGNOSTICS**

---

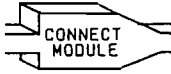
<b>Type:</b>	Module Substitution	<b>CTL.11</b>
<b>Run time:</b>	0	
<b>Set-up time:</b>	2-4 min.	

**Replace Module**

1. Switch instrument to **Standby** (if you are replacing A1 Module disconnect line power also).
2. Remove **substitute** module from instrument and return to On-Site Service Kit.
3. Replace instrument's module in instrument. (Refer to foldout in **MECHANICAL PROCEDURES** to locate replacement information.)
4. Turn instrument on.
5. Return to foldout.



---

## A2 MODULATION MODULE

---

### 3E-1. INTRODUCTION

The **MODULE LEVEL DIAGNOSTICS (MLD)** contained in this section are used to further interrogate the **A2 Module**. The objective is to isolate the failure indicated for this module to the module itself or to a part on which it depends for operation.

#### NOTE

*At this level of testing, recommendations for further action are made on the assumption that the **INSTRUMENT LEVEL DIAGNOSTICS (ILD)** showed no failures for modules **A01, A03 or A04**. (For information on using the on-site diagnostics, refer to the **INTRODUCTION** section of this manual.)*

#### CAUTION

*When tightening the coax cable connectors, do not exceed a torque of 1.0 Nm or .74 ft-lbs (slightly tighter than finger tight).*

*When coax cables are disconnected from instrument, do not allow loose ends to come in contact with any exposed circuitry susceptible to short circuiting.*

#### Test Instructions

1. The instrument's **Front Panel** must be opened to run many of these tests. (Refer to the table on the foldout in **MECHANICAL PROCEDURES** to locate instructions.)
2. The last page in this group of tests is a foldout and should be pulled out now.
3. Proceed to the next page to begin the **A2 MLD**.

---

## A2 MODULE SUBSTITUTION

---

### 3E-2. INTRODUCTION

#### NOTE

*If a known good module is not available, proceed to the next page A2 INPUTS/OUTPUTS VERIFICATION.*

The first step in isolating an A2 failure is to substitute in a known good module from the On-Site Service Kit.

#### A2 Substitution Instructions

1. Find **A2 MODULE SUBSTITUTION** on the foldout.
2. Use the Task Sequence Diagram, shown under **A2 MODULE SUBSTITUTION**, to direct you through the substitution process. Each Task Arrow shown in the diagram indicates a task title and task number. The tasks are numbered according to the order in which they appear in this section. Turn to the task indicated and complete the procedure.
3. After completing the procedure, return to the Task Sequence Diagram on the foldout and determine the next task to be performed.
4. Begin now by performing the first task shown on the diagram.

---

**A2 INPUTS/OUTPUTS VERIFICATION**

---

**3E-3. INTRODUCTION**

If a known good A2 Module is not available, or if you were not able to isolate the failure using the **A2 MODULE SUBSTITUTION** procedure, the Task Sequence Diagrams (shown under **A2 INPUTS/OUTPUTS VERIFICATION**) should be used to check each signal path into the A2 Module.

**A2 Inputs/Outputs Verification Instructions**

1. Find **A2 INPUTS/OUTPUTS VERIFICATION** on the foldout.
2. The Task Sequence Diagrams, shown under **A2 INPUTS/OUTPUTS VERIFICATION**, are separated into four checks: **Modulation Input/Output Ports**, **Audio to Instrument**, **Control signals**, and **Power Supply signals**.
3. Use the Task Sequence Diagrams to guide you through the verification process. Each Task Arrow shown in a diagram contains a task number and task title. The tasks are numbered according to the order in which they appear in this section. Turn to the task indicated and complete the procedure.
4. After completing the procedure, return to the Task Sequence Diagram on the foldout and determine the next task to be performed.
5. Begin now by performing the first task shown under **1. MODULATION I/O PORTS CHECK**.

**NOTE**

*The A2 MODULE I/O SIGNALS DIAGRAM shows all parts directly associated with modulation.*



**A2 MODULE DIAGNOSTICS**

---

Type:	1; Modulation Self Test	A2.02
Run time:	1 min.	
Set-up time:	1 min.	

**Run Test**

1. **INSTR PRESET** **SHIFT**  
 (Hold shift key until "100.000000MZ -140.0DM" appears, to override 20 second reset test.)
2. **SHIFT** **SPCL** **3** **3** **1** **6** **HZ**.
3. When "WAITING FOR SET-UP 1 .V24" appears:
  - Connect BNC Tee connector, from On-Site Service Kit, to "FM/ΦM INPUT". (See foldout in INSTRUMENT LEVEL DIAGNOSTICS (ILD) for set-up diagram.)
  - Connect a coax cable from Tee connector to "MOD OUTPUT".
  - Connect a cable from Tee to "AM/PULSE INPUT".
  - **HZ** to continue test.
4. When "DIAG DONE HIT MSSGE .V1" appears:
  - Use **MSSG** to scroll through messages.
  - Record error code(s) displayed for A2.

**COMMENT**

*If any error codes are displayed for modules A01, A03, or A04, you need to isolate those failure(s) before performing the A2 MODULE SUBSTITUTION. (Refer to INSTRUMENT LEVEL DIAGNOSTICS to determine correct order for troubleshooting modules.)*

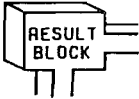
5. Return to foldout:
  - Determine next task by comparing test results to conditions shown in each  for TEST A2 MODULE.

---

## A2 MODULE DIAGNOSTICS

---

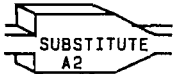
Type:	Module Substitution	A2.03
Run time:	0	
Set-up time:	5 min	

The following describes the technique for connecting a known good A2 Module without removing the A2 Module in the instrument.

### Connect Substitute Module

1. Switch instrument to Standby.
2. Disconnect all cables to A2 Module; W14, W17 through 22, and W33. (See A2 MODULE CABLE CONNECTION LOCATOR on foldout.)
  - Clip cable ties holding cable bundle to module ties.
3. Without removing A2 Module from instrument, carefully lay substitute A2 Module against A2 Module in instrument.
4. Connect cables W14, W17 through 22 and W33 to substitute module.
5. Pivot substitute A2 Module away from A2 Module in instrument.
  - Support from cables should allow substitute module to be placed in a free standing position.

CAUTION

*If circuit side of substitute A2 is permitted to contact A2 Module in instrument, damage could result to either module. If Front Panel contacts substitute A2 Module, damage could result to substitute A2 Module.*

6. Carefully turn instrument on.
  7. Return to foldout.
-

**A2 MODULE DIAGNOSTICS**

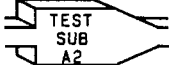
Type:	Substitute Module Test	A2.04
Run time:	1 min.	
Set-up time:	1 min.	

Test operation of substitute A2 Module by repeating test performed on A2 Module before substitution.

**CAUTION**

*Do not allow Front Panel to swing against substitute A2 Module while instrument is turned on.*

**Run Test**

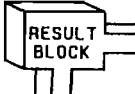
1. **INSTR PRESET** **SHIFT**  
 (Hold shift key until "100.000000MZ -140.0DM" appears, to override 20 second reset test.)
2. **SHIFT** **SPCL** **3** **3** **1** **6** **HZ**
3. When "WAITING FOR SET-UP 1 .V24" appears:
  - Use same set-up as in previous test.
4. When "DIAG DONE HIT MSSGS .V1" appears:
  - Use **MSSG** to scroll through messages.
  - Record error code(s) displayed for A2.
5. Return to foldout:
  - Determine next task by comparing test results to conditions shown in each  for TEST SUB A2.

**A2 MODULE DIAGNOSTICS**

---

Type:	Additional A2 Tests	A2.05
Run time:	Conditional	
Set-up time:	Conditional	

The **A2 Module** failure conditions for arriving at this task are described below. Follow the procedure for the condition which fits your module.

- Condition 1: Instrument Level Diagnostics indicated A2 failure.
- Condition 2: Failure indicated for another module appears to be modulation related.
- Condition 3: Instrument must be set to a specific operating condition to detect A2 failure.

Condition 1

1.    
 (Hold shift key until "100.000000MZ -140.0DM" appears, to override 20 second reset test.)
2.
3. When "WAITING FOR SET-UP 1 .V24" appears:
  - Connect BNC Tee connector, from On-Site Service Kit, to "FM/ΦM INPUT" (see foldout in INSTRUMENT LEVEL DIAGNOSTICS (ILD) for set-up diagram).
  - Connect a coax cable from Tee connector to "MOD OUTPUT".
  - Connect a coax cable from Tee to "AM/PULSE INPUT".
  - to continue test.
4. When "DIAG DONE HIT MSSGS .V1" appears:
  - Use  to scroll through messages.
  - Record error code(s) displayed for A2.

**COMMENT**

*If any error codes are displayed for modules A01, A03, or A04, you need to isolate those failure(s) before performing the A2 MODULE SUBSTITUTION. (Refer to INSTRUMENT LEVEL DIAGNOSTICS to determine correct order for troubleshooting modules.)*

5. Return to foldout.
-

---

**A2 MODULE DIAGNOSTICS**

---

**Condition 2**

1. Rerun test which generates modulation related failures.
2. Record test results.
3. Return to foldout.

**Condition 3**

1. Set instrument to operating condition which causes **A2** failure.
  2. Record instrument set-up and error message(s).
  3. Return to foldout.
-

**A2 MODULE DIAGNOSTICS**

Type:	Additional Substitute	A2.06
Run time:	A2 Tests	
Set-up time:	Conditional	

Test operation of substitute **A2 Module** by repeating test(s) performed on **A2 Module** before substitution.

- Condition 1: Instrument Level Diagnostics indicated **A2** failure.
- Condition 2: Failure indicated for another module appears to be modulation related.
- Condition 3: Instrument must be set to a specific operating condition to detect **A2** failure.

Condition 1

1.    
 (Hold shift key until "100.000000MZ -140.0DM" appears, to override 20 second reset test.)
2.
3. When "WAITING FOR SET-UP 1 .V24" appears:
  - Connect BNC Tee connector, from On-Site Service Kit, to "FM/ΦM INPUT" (see foldout in **INSTRUMENT LEVEL DIAGNOSTICS (ILD)** for set-up diagram).
  - Connect a coax cable from Tee connector to "MOD OUTPUT".
  - Connect a coax cable from Tee to "AM/PULSE INPUT".
  - to continue test.
4. When "DIAG DONE HIT MSGS .V1" appears:
  - Use  to scroll through messages.
  - Record error code(s) displayed for **A2**.

**COMMENT**

*If any error codes are displayed for modules A01, A03, or A04, you need to isolate those failure(s) now.*

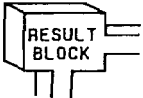
5. Return to foldout:
  - Determine next task by comparing test results to conditions shown in each  for **TEST SUB A2 FURTHER**.

---

**A2 MODULE DIAGNOSTICS**

---

**Condition 2**

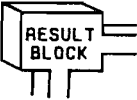
1. Rerun test which generates modulation related failures
2. Record test results.
3. Return to foldout.
  - Determine next task by comparing test results to conditions shown in each  for TEST SUB A2 FURTHER.

**Condition 3**

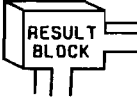
1. Set instrument to operating condition which causes A2 failure.
2. Record instrument set-up and error message(s).
3. Return to foldout.
  - Determine next task by comparing test results to conditions shown in each  for TEST SUB A2 FURTHER.

---

**A2 MODULE DIAGNOSTICS**

---

Type:	Cable Connection	A2.07
Run time:	0 min.	
Set-up time:	5 min.	

**Connect Module**

1. Switch instrument to Standby.
2. Disconnect cables W14, W17 through W22 and W33 from substitute A2 Module.
3. Reconnect cables W14, W17 through W22 and W33 to A2 Module and replace cable ties holding cable bundles to module with ties provided in On-Site Service Kit.
4. Turn instrument on.
5. Return substitute A2 Module to On-Site Service Kit.
6. Return to foldout.



**A2 MODULE DIAGNOSTICS**

Type:	1; Modulation Self Test	A2.08
Run time:	1 min.	
Set-up time:	1 min.	

This is the same test used to test A2 Module during module substitution process. If you made an accurate record of test results for that test, it is not necessary to rerun test now; instead proceed directly to step 5.

**Run Test**

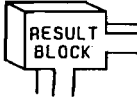
1.    
 (Hold shift key until "100.000000MZ -140.0DM" appears, to override 20 second reset test.)
2.
3. When "WAITING FOR SET-UP 1 .V24" appears:
  - Connect BNC Tee connector, from On-Site Service Kit, to "FM/ΦM INPUT" (see foldout in INSTRUMENT LEVEL DIAGNOSTICS (ILD) for set-up diagram).
  - Connect a coax cable from Tee connector to "MOD OUTPUT".
  - Connect a coax cable from Tee to "AM/PULSE INPUT".
  - to continue test.
4. When "DIAG DONE HIT MSSGS .V1" appears:
  - Use  to scroll through messages.
  - Record error code(s) displayed for A2.
5. Return to foldout:
  - Determine next task by comparing test results to conditions shown in each  for TEST MOD PORTS.

---

**A2 MODULE DIAGNOSTICS**

---

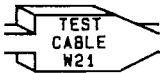
Type:	1; Modulation Self Test	A2.09
Run time:	1 min.	
Set-up time:	6 min.	

Cable **W21** is tested by by-passing it during testing.

**Run Test**

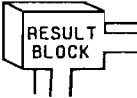
1. **[INSTR PRESET]** **[SHIFT]**  
Hold shift key until  
"100.000000MZ -140.0DM" appears,  
to override 20 second reset test.)
2. **[SHIFT]** **[SPCL]** **[3]** **[3]** **[1]** **[6]** **[HZ]**
3. When "WAITING FOR SET-UP 1 .V24" appears:
  - Connect "FM/ΦM INPUT", "MOD OUTPUT" and "AM/PULSE INPUT" same as previous test.
4. Test cable **W21**:
  - Disconnect cable **W21** from **A2** Module at **A2J8** (see **A2 MODULE CABLE CONNECTION LOCATOR** on fold-out) and from **A6** Module at **A6A2 J3** (see **Top View Diagram** on inside of Top Cover to locate **W21** connection on **A6** Module). (See table on foldout in **MECHANICAL PROCEDURES** to locate Top Cover removal information.)
  - Substitute test coax cable from On-Site Service Kit between **A2J8** and **A6** Module at **A6A2 J3**.
  - **[HZ]** to continue.
5. When "DIAG DONE HIT MSSGS .V1" appears:
  - Reconnect cable **W21** to modules **A2** and **A6**.
  - Use **[MSSG]** to scroll through messages.
  - Record error code(s) displayed for **A2**.
6. Return to foldout:
  - Determine next task by comparing test results to conditions shown in each  for **TEST CABLE W21**.

---

**A2 MODULE DIAGNOSTICS**

---

Type:	1; Modulation Self Test	<b>A2.10</b>
Run time:	1 min.	
Set-up time:	8 min.	

Cables **W17**, **W18** and **W19** are tested by separately by-passing each cable and rerunning test.

**Test Cable W19**

1.    
 Hold shift key until "100.000000MZ -140.0DM" appears, to override 20 second reset test.)
2.
3. When "WAITING FOR SET-UP 1 .V24" appears:
  - Disconnect BNC Tee connector from "FM/ΦM INPUT", leave BNC cables connected to "MOD OUTPUT" and "AM/PULSE INPUT" as in previous test.
  - Connect BNC-to-SMC adapter, SMC barrel adapter, and test coax cable (from On-Site Service Kit) to Tee connector.
4. Connect substitute cable:
  - Disconnect cable **W19** from A2 Module at A2J5. (See **A2 MODULE CABLE CONNECTIONS LOCATOR** on foldout to locate A2J5.)
  - Connect the coax cable from Tee connector to A2 Module at A2J5.
  - to continue.
5. When "DIAG DONE HIT MSSGS .V1" appears:
  - Reconnect cable **W19** to A2 Module.
  - Use  to scroll through messages.
  - Record error code(s) displayed for A2.

**Test Cable W17**

6. Repeat steps 1 and 2.
  7. When "WAITING FOR SET-UP 1 .V24" appears:
    - Disconnect BNC cable from "MOD OUTPUT" and connect to "FM/ΦM INPUT".
-

---

### A2 MODULE DIAGNOSTICS

---

8. Connect substitute cable:
  - Disconnect cable W17 from A2 Module at A2J7.
  - Connect loose end of test cable to A2 Module at A2J7.
  - **[HZ]** to continue test.
9. When "DIAG DONE HIT MSSGS.V1" appears:
  - Reconnect cable W17 to A2 Module.
  - Use **[MSSG]** to scroll through messages.
  - Record error code(s) displayed for A2.

#### Test cable W18

10. Repeat steps 1 and 2.
11. When "WAITING FOR SET-UP 1 .V24" appears:
  - Disconnect BNC cable from "AM/PULSE INPUT" and connect to "MOD OUTPUT".
12. To connect substitute cable:
  - Disconnect cable W18 from A2 Module at A2J2.
  - Connect loose end of test cable to A2 Module at A2J2.
  - **[HZ]** to continue test.
13. When "DIAG DONE HIT MSSGS.V1" appears:
  - Reconnect cable W18 to A2 Module.
  - Use **[MSSG]** to scroll through messages.
  - Record error code(s) displayed for A2.

#### NOTE

*If tests did not pass for any of the cable substitution attempts, you should have gotten the same error set for each test. If you did not get the same errors, recheck cable connections and rerun test.*

14. Return to foldout:
  - Determine next task by comparing test results to conditions shown in each **RESULT BLOCK** for TEST CABLES W17, 18 and 19.

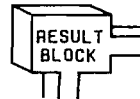

---

**A2 MODULE DIAGNOSTICS**

---

Type:	2; Audio Output Levels	A2:11
Run time:	30 sec.	
Set-up time:	6 min.	

**Run Test**

1.    
 Hold shift key until  
 "100.000000MZ -140.0DM" appears,  
 to override 20 second reset test.)
2.
3. When "WAITING FOR SET-UP 1 .V24" appears:
  - Disconnect cable W22 from A13 Module at A13A2 J4 (See Top View Diagram inside Top Cover to locate W22 on A13).
  - Connect cable W22 to "AM/PULSE INPUT" using BNC cable and BNC-to-SMC adapter with barrel adapter from On-Site Service Kit.
  - If an HP 8642A is being tested, push  now and proceed to step 4.

CAUTION

*Extending the A19 Module exposes the circuit side of the A17 Power Supply Regulators/Attenuator Drivers Module. Do not permit the loose end of W33 to contact the A17 Module.*

- If an HP 8642B is being tested, disconnect cable W33 from A19 Module at A19A1 J6. To access A19A1 J6, extend A19 Module. (See table on foldout in MECHANICAL PROCEDURES for module extending information).
  - Connect cable W33 to "FM/ΦM INPUT" using cabling method described for W22.
  - to continue.
-

---

### A2 MODULE DIAGNOSTICS

---

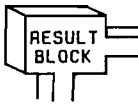
4. When "WAITING FOR SET-UP 2 .V25" appears:
  - Reconnect cables W22 and (W33 HP 8642B only) to modules.
  - Disconnect cable W20 from A6 Module at A6A1 J4.
  - Connect cable W20 to "AM/PULSE INPUT".
  - Connect "FM/ΦM INPUT" to "MOD OUTPUT".
  - to continue.
  
5. When "RECONNECT ALL CABLES .V29" appears:
  - Reconnect cable W20 to A6 Module.
  - to continue.
  
6. When "DIAG DONE HIT MSSGS .V1" appears:
  - Use  to scroll through messages.
  - Record error code(s) displayed for A2.
  - If "TEST 2 OF A02 (PASSED or FAILED)" is not displayed, rerun test.
  
7. Return to foldout:
  - Determine next task by comparing test results to conditions shown in each  for TEST AUDIO TO A6, 13 and 19.

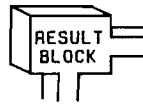

---

**A2 MODULE DIAGNOSTICS**

---

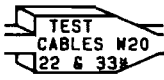
Type:	2; Audio Output Levels	A2.12
Run time:	30 sec.	
Set-up time:	5 min.	

Cables W20, W22, and W23 are tested by substituting in a test cable for each of these cables during testing.

Run Test

1.    
 (Hold shift key until "100.000000MZ -140.0DM" appears, to override 20 second reset test.)
  2.
  3. When "WAITING FOR SET-UP 1 .V24" appears:
    - Disconnect cable W22 from A2 Module at A2J3 (see **MODULE CABLE CONNECTION LOCATOR** on fold-out to locate W22). (See table on foldout in **MECHANICAL PROCEDURES** for opening Front Panel information.)
    - Using BNC cable and BNC-to-SMC adapter, SMC barrel, and SMC coax cable from On-Site Service Kit, connect A2 Module (at A2J3) to "AM/PULSE INPUT".
    - If an HP 8642A is being tested, push  now and proceed to step 4.
    - If an HP 8642B is being tested, disconnect cable W33 from A2 Module at A2J4.
    - Using same cabling method described for W22, connect A2 Module (at A2J4) to "FM/ΦM INPUT"
  4. When "WAITING FOR SET-UP 2 .V25" appears:
    - Reconnect cables W22 and (W33 HP 8642B only) to A2 Module.
    - Disconnect cable W20 from A2 Module at A2J6.
    - Connect A2 Module (at A2J6) to "AM/PULSE INPUT".
    - Connect "FM/ΦM INPUT" to "MOD OUTPUT".
    - to continue.
-

**A2 MODULE DIAGNOSTICS**

---

5. When "RECONNECT ALL CABLES .V29" appears:
  - Reconnect cable **W20** to **A2 Module**.
  - **[HZ]** to continue.
  
6. When "DIAG DONE HIT MSSGS.V1" appears:
  - Use **[MSSG]** to scroll through messages.
  - Record error code(s) displayed for **A2**.
  - If "TEST 2 OF A02 (PASSED or FAILED)" is not displayed, rerun test.
  
7. If test failed, proceed directly to step 8, otherwise continue testing.
  - A passing test indicates that one of the by-passed cables (**W20, W22** or **W23**) was cause of failure.
  - To isolate defective cable, rerun test two more times connecting cables as follows:
 

**Test 1:** Connect cables **W22** and **W33** as described in step 3 of this test (by-passed). Connect **W20** as described in step 4 of previous test (not by-passed).

**Test 2:** Connect cable **W22** as described in previous test (not by-passed). Connect **W33** and **W20** as described in this test (by-passed).

  - Use the following chart to determine defective cable:

Test 1	Test 2	Defective Cable(s)
F	P	W20
P	F	W22
F	F	Cables W20 and W22
P	P	W33



---

**A2 MODULE DIAGNOSTICS**

---

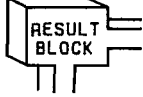
8. When testing is complete, return to foldout:
- Determine next task by comparing test results to conditions shown in each  for **TEST CABLES** W20, 22 and 33.

---

**A2 MODULE DIAGNOSTICS**

---

Type:	3; Bit Transmission	<b>A2.13</b> 
Run time:	6 min.	
Set-up time:	2 min.	

Internal Voltmeter (VM) is used to measure TTL level changes transmitted to A2 Module on Clock and Data control lines D0 through D7.

#### COMMENTS

*Check control line inputs to A2 by performing test procedure for control lines shown in Table 3E-1.*

*If any control line measures bad, it is not necessary to test remaining lines; proceed to step 14.*

#### Run Test

1. Switch instrument to **Standby**:
  - Disconnect cable W14 from module at A2J1.
  - Plug end of W14 into 20 pin test connector, from On-site Service Kit.

#### NOTE

*Find arrowhead on test connector and align with arrowhead on cable plug W14P2.*

#### CAUTION

*To prevent damage to the Power Supply and Control sections, do not permit the exposed pins on the test connector to short circuit.*

2. Connect VM probe:
    - Connect red alligator clip and retractable hook probe to red test lead provided in On-Site Service Kit.
    - Connect alligator clip to VM IN (A4TP1). (See A2 MODULE CABLE CONNECTION LOCATOR on fold-out for VM IN location.)
  3. Turn instrument on.
-

**A2 MODULE DIAGNOSTICS**

**Clock and Data Control Lines**

**Check High State**

4.  SHIFT  SPCL  3  6  0  1  
(To specify high state.)
5. Enter **Bit Select Keys** as indicated in **Table 3E-1**. **W14P2 Control Bits**, for **Control Line** to be tested.
6. Connect **VM probe Control Line** at **Pin Number** indicated in **Table 3E-1**. (See **Figure 3E-1**. **Cable Plug W14P2 Signal Locator**.)

**Table 3E-1. W14P2 Control Bits**

<b>Test Order</b>	<b>Control Line</b>	<b>Bit Select Keys (Steps 5 and 10)</b>	<b>Pin Number (Step 6)</b>
1	MOD CLK	<input type="checkbox"/> 6 <input type="checkbox"/> 0 <input type="checkbox"/> HZ	11
2	D0	<input type="checkbox"/> 4 <input type="checkbox"/> 8 <input type="checkbox"/> HZ	1
3	D1	<input type="checkbox"/> 4 <input type="checkbox"/> 9 <input type="checkbox"/> HZ	2
4	D2	<input type="checkbox"/> 5 <input type="checkbox"/> 0 <input type="checkbox"/> HZ	3
5	D3	<input type="checkbox"/> 5 <input type="checkbox"/> 1 <input type="checkbox"/> HZ	4
6	D4	<input type="checkbox"/> 5 <input type="checkbox"/> 2 <input type="checkbox"/> HZ	5
7	D5	<input type="checkbox"/> 5 <input type="checkbox"/> 3 <input type="checkbox"/> HZ	6
8	D6	<input type="checkbox"/> 5 <input type="checkbox"/> 4 <input type="checkbox"/> HZ	7
9	D7	<input type="checkbox"/> 5 <input type="checkbox"/> 5 <input type="checkbox"/> HZ	8

**A2 MODULE DIAGNOSTICS**

**Figure 3E-1. Cable Plug W14P2 Signal Locator**

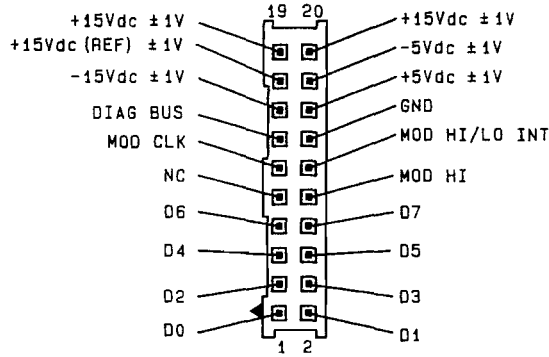

7.    (To enable voltmeter.)
8. Voltage should read approximately +2.5 to +5.5 Vdc.   to repeat measurement.)

**Check Low State**

9.       (To specify low state.)
10. Enter Bit Select Keys as indicated in Table 3E-1. W14P2 Control Bits, for same Control Line.
11.    (To enable voltmeter.)
12. Voltage should read approximately -0.5 to +1.5 Vdc.   to repeat measurement.)
13. Repeat procedure for each Control Line shown in Table 3E-1.
14. Record test results.
15. Return to foldout:
  - ⊗ Determine next task by comparing test results to conditions shown in each **RESULT BLOCK** for TEST CONTROL BITS.

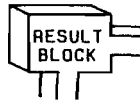

---

**A2 MODULE DIAGNOSTICS**

---

Type:	Voltage Measurements	A2.14
Run time:	2 min.	
Set-up time:	6 min.	

Internal Voltmeter (VM) is used to check power supply levels at inputs to A2 Module.

**Run Test**

- Switch instrument to Standby:
  - Disconnect W14 from A2 at A2J1.
  - Plug end of W14 into 20 pin test connector, from On-site Service Kit.

**NOTE**

*Find arrowhead on test connector and align with arrowhead on cable plug W14P2.*

- Connect VM probe:
  - Connect red alligator clip and retractable hook probe to red test lead provided in On-Site Service Kit.
  - Connect alligator clip to VM IN (A4TP1). (See A2 MODULE CABLE CONNECTION LOCATOR on fold-out for VM IN location.)
- Turn instrument on and enter:
 

SHIFT	SPCL	3	2	5	HZ
-------	------	---	---	---	----

 (To enable Internal Voltmeter.)

**A2 MODULE DIAGNOSTICS**

4. Measure voltage levels:
  - Connect VM probe to test connector pin for each power supply line (see Figure 3E-2. Cable Plug W14P2 Signal Locator).
  - **5** **HZ** (To make each voltage measurement.)

**Figure 3E-2. Cable Plug W14P2 Signal Locator**

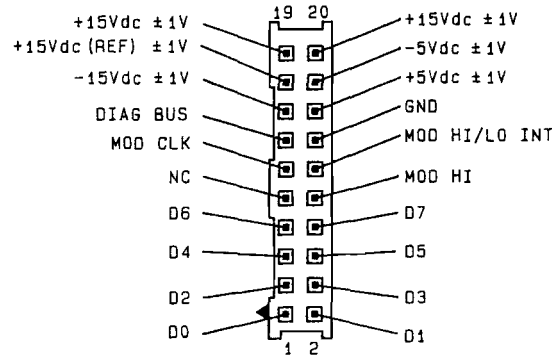

5. Record test results.
6. Return to foldout:
  - Determine next task by comparing test results to conditions shown in each **RESULT BLOCK** for TEST Vdc.

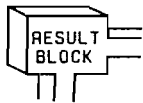

---

**A2 MODULE DIAGNOSTICS**

---

Type:	Cable Substitution
Run Time:	5 min.
Set-up Time:	1 min.

A2.15

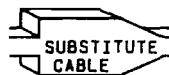

1. Testing has shown cable **W20**, **W21**, **W22**, or **W33** to be defective, temporarily replace with a test cable from the On-Site Service Kit. Rerun **INSTRUMENT LEVEL DIAGNOSTICS (ILD)** to confirm repair.
2. Refer to **REPLACEABLE PARTS**, in **HP 8642A/B** Operating and Service Manual, for information to order a permanent replacement cable.
3. Return to foldout.

---

**A2 MODULE DIAGNOSTICS**

---

Type:	Cable Check	A2.16
Run time:	N/A	
Set-up time:	N/A	

1. Replacement of cable **W14** is not considered an on-site procedure due to extensive disassembly required.
2. To further test **W14**, verify integrity of signal source by proceeding as directed on foldout.
3. Reconnect cable **W14** to **A2 Module**.
4. Return to foldout.



---

## A2 THEORY OF OPERATION

---

### 3E-4. A2 MODULATION MODULE

#### COMMENT

*It is not to essential to understand the internal operation of a module to make an on-site repair.*

The **A2 Module** generates an audio signal from **10 Hz** to **100 kHz**. This signal is provided to the **A6 FM Loop** frequency and phase modulation and to the **A13 Output Loop** for amplitude modulation. In the **HP 8642B** this signal is sent to the **A19 Doubler** for amplitude modulation in the **Doubler Band (1057.5 to 2115 MHz)**.

The output of **A2's Internal Audio Oscillator** is also sent to the **A6 Counter**. The frequency count generated by the counter is passed to the **A3 Processor**. The Processor compares the frequency count with the specified setting for the audio oscillator and fine tunes the oscillator until the frequency count matches the specified frequency setting.

The **A2 Module** accepts external modulation signals via the "**AM/PULSE**" and "**FM/ΦM**" input ports.

See the **A2 MODULE SIMPLIFIED BLOCK DIAGRAM** for further understanding of the **A2 Module's** internal operation.

---

**A6 FM LOOP/COUNTER/TIMEBASE MODULE**

---

**3F-1. INTRODUCTION**

The **MODULE LEVEL DIAGNOSTICS (MLD)** contained in this section are used to further interrogate the **A6 Module**. The objective is to isolate the failure indicated for this module to the module itself or to a part on which it depends for operation.

**NOTE**

*At this level of testing, recommendations for further action are made on the assumption that the **INSTRUMENT LEVEL DIAGNOSTICS (ILD)** showed no failures for modules **A01, A03** or **A04**. (For information on using the on-site diagnostics, refer to the **INTRODUCTION** section of this manual.)*

**CAUTION**

*When tightening the coax cable connectors, do not exceed a torque of 1.0 Nm or .74 ft-lbs (slightly tighter than finger tight).*

*When coax cables are disconnected from instrument, do not allow loose ends to come in contact with any exposed circuitry susceptible to short circuiting.*

**Test Instructions**

1. The instrument's **Top Cover** must be removed to run many of these tests. (Refer to table on foldout in **MECHANICAL PROCEDURES** to locate instructions.)
2. The last page in this group of tests is a foldout and should be pulled out now.
3. Turn to the next page to begin the **A6 MLD**.

---

## A6 MODULE SUBSTITUTION

---

### 3F-2. INTRODUCTION

#### NOTE

*If a known good module is not available, proceed to the next page, A6 INPUTS VERIFICATION.*

The first step in isolating an A6 failure is to substitute in a known good module from the On-site Service Kit.

#### A6 Substitution Instructions

1. Find **A6 MODULE SUBSTITUTION** on the foldout.
  2. Use the Task Sequence Diagram, shown under **A6 MODULE SUBSTITUTION**, to direct you through the substitution process. Each Task Arrow shown in the diagram indicates a task title and task number. The tasks are numbered according to the order in which they are arranged in this section. Turn to the task indicated and complete the procedure.
  3. After completing the procedure, return to the Task Sequence Diagram on the foldout and determine the next task to be performed.
  4. Begin now by performing the first task shown on the diagram.
-

---

**A6 INPUTS VERIFICATION**

---

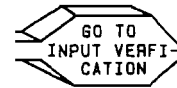
**A6.01****3F-3. INTRODUCTION**

If a known good **A6 Module** is not available, or if you were not able to isolate the failure using the **A6 MODULE SUBSTITUTION** procedure, the Task Sequence Diagrams (shown under **A6 INPUTS VERIFICATION**) should be used to check each signal path into the **A6 Module**.

**A6 Inputs Verification Instructions**

1. Find **A6 INPUTS VERIFICATION** on the foldout.
2. The Task Sequence Diagrams, shown under **A6 INPUTS VERIFICATION**, are separated into three checks: **Control**, **Power Supply** and **RF** signals.
3. Use the Task Sequence Diagrams to direct you through the verification process. Each Task Arrow shown in a diagram indicates a task title and task number. The tasks are numbered according to the order in which they are arranged in this section. Turn to the task indicated and complete the procedure.
4. After completing the procedure, return to the Task Sequence Diagram on the foldout and determine the next task to be performed.
5. Begin now by performing the first task shown under 1. **A6 CONTROL INPUT CHECK**.

**NOTE**

*The **A6 MODULE I/O SIGNALS DIAGRAM** shows all parts which the **A6 Module** depends on for operation.*

**A6 MODULE DIAGNOSTICS**

Type:	1; Loop Lock/Unlock	<b>A6.02</b>
Run time:	1 min.	
Set-up time:	0	

**Run Test**

1. **INSTR PRESET** **SHIFT**  
 (Hold shift key until "100.000000MZ -140.0DM" appears, to override 20 second reset test.)
2. **SHIFT** **SPCL** **3** **3** **2** **0** **HZ**.
3. When "DIAG DONE HIT MSSG .V1" appears:
  - Use **MSSG** to scroll through messages.
  - Record error code(s) displayed for A6. If "TEST 1 OF A06 (PASSED or FAILED)" is not displayed, rerun test.

**COMMENT**

*If any error codes are displayed for modules A01, A03 or A04, you need to isolate those failure(s) before performing the A6 MODULE SUBSTITUTION. (Refer to INSTRUMENT LEVEL DIAGNOSTICS to determine correct order for troubleshooting modules.)*

4. Return to foldout:
  - Determine next task by comparing test results to conditions shown in each  for TEST A6 MODULE.

---

**A6 MODULE DIAGNOSTICS**

---

<b>Type:</b>	Module Substitution	A6.03
<b>Run time:</b>	0	
<b>Set-up time:</b>	7 min.	

The following describes the technique for connecting a known good A6 Module without removing the A6 module in the instrument.

Connect Substitute Module

1. Switch instrument to **Standby**.
2. Disconnect cables **W1, W20, W21, W23, W24, W26, W27, W28** and **W29** from **A6** Module (see **A6 MODULE CABLE CONNECTION LOCATOR** on foldout).
3. Without removing **A6** Module from instrument, carefully lay substitute **A6** Module on top of modules **A7, A9** and **A11**.

CAUTION

*When connecting ribbon cable, find arrowhead on cable connector and align with arrowhead on board connector.*

4. Connect cables **W1, W20, W21, W23, W24, W26, W27, W28** and **W29** to substitute module.
  5. Turn instrument on.
  6. Return to foldout.
-

**A6 MODULE DIAGNOSTICS**

---

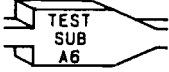
Type:	Substitute Module Test	<b>A6.04</b>
Run time:	1 min.	
Set-up time:	0	

Test operation of **substitute A6 Module** by repeating test performed on A6 Module before substitution.

**Run Test**

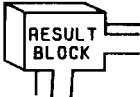
1. **[ INSTR PRESET ] [ SHIFT ]**  
 (Hold shift key until "100.000000MZ -140.0DM" appears, to override 20 second reset test.)
2. **[ SHIFT ] [ SPCL ] [ 3 ] [ 3 ] [ 2 ] [ 0 ] [ HZ ]**.
3. When "DIAG DONE HIT MSSG .V1" appears:
  - Use **[ MSSG ]** to scroll through messages.
  - Record error code(s) displayed for **A6**. If "TEST 1 OF A06 (PASSED or FAILED)" is not displayed, rerun test.
4. Return to foldout:
  - Determine next task by comparing test results to conditions shown in each  for **TEST SUB A6**.

---

**A6 MODULE DIAGNOSTICS**

---

Type:	Additional A6 Tests	A6.05
Run time:	Conditional	
Set-up time:	Conditional	

The **A6** failure conditions for arriving at this task are described below. Follow the procedure for the condition which fits your module.

- Condition 1: Instrument Level Self Test indicated **A6** failure.
- Condition 2: **RF Power Test** for another module indicated **A6** failure.
- Condition 3: Instrument must be set to a specific operating condition to detect **A6** failure.

**Condition 1**

1. **INSTR PRESET** **SHIFT**  
(Hold shift key until "100.000000MZ -140.0DM" appears, to override 20 second reset test.
2. **SHIFT** **SPCL** **3** **3** **0** **HZ**.
3. When "WAITING FOR SET-UP 1 .V24" appears:
  - Connect BNC Tee connector, from On-Site Service Kit, to "FM/ΦM INPUT" (see **INSTRUMENT LEVEL DIAGNOSTICS** foldout for set-up diagram).
  - Connect a coax cable from Tee connector to "MOD OUTPUT".
  - Connect a coax cable from Tee to "AM/PULSE INPUT"
4. When "DIAG DONE HIT MSSGS .VI" appears:
  - Use **MSSG** to scroll through messages.
  - Record **A6** error codes.

**COMMENT**

*If any error codes are displayed for modules A01, A03 or A04, you need to isolate those failure(s) before performing the A6 MODULE SUBSTITUTION. (Refer to INSTRUMENT LEVEL DIAGNOSTICS to determine correct order for troubleshooting modules.)*

5. Return to foldout.
-



---

**A6 MODULE DIAGNOSTICS**

---

**Condition 2**

1. **INSTR PRESET** **SHIFT**  
(Hold shift key until "100.000000MZ -140.0DM" appears, to override 20 second reset test.)
  2. **SHIFT** **SPCL** **3** **3** **2** **2** **HZ**
  3. When "WAITING FOR SET-UP 1 .V24" appears:
    - Disconnect cable **W28** from module at **A6A2 J8**.
    - Connect **YELLOW PM** cable to module at **A6A2 J8**.
    - **HZ** to continue test.
  4. When "WAITING FOR SET-UP 2 .V25" appears:
    - Reconnect cable **W28** to module at **A6A2 J8**.
    - Disconnect cable **W26** from module at **A6A2 J6**.
    - Connect **PM** cable to module at **A6A2 J6**.
    - **HZ** to continue test.
  5. When "WAITING FOR SET-UP 3 .V26" appears:
    - Reconnect cable **W26** to module at **A6A2 J6**.
    - Disconnect cable **W29** from module at **A6A2 J9**.
    - Connect **PM** cable to module at **A6A2 J9**.
    - **HZ** to continue test.
  6. When "WAITING FOR SET-UP 4 .V27" appears:
    - Reconnect cable **W29** to module at **A6A2 J9**.
    - Disconnect cable **W23** from module at **A6A2 J5**.
    - Connect **PM** cable to module at **A6A2 J5**.
    - **HZ** to continue test.
  7. When "WAITING FOR SET-UP 5 .V28" appears:
    - Reconnect cable **W23** to module at **A6A2 J5**.
    - Disconnect cable **W24** from module at **A6A1 J2**.
    - Connect **PM** cable to module at **A6A1 J2**.
    - **HZ** to continue test.
  8. When "RECONNECT ALL CABLES .V29" appears:
    - Reconnect cable **W24** to module at **A6A1 J2**.
    - **HZ** to continue test.
  9. When "DIAG DONE HIT MSSGS .V1" appears:
    - Use **MSSG** to scroll through messages.
    - Record error code(s) displayed for **A6**. If "TEST 2A OF A06 (PASSED or FAILED)" is not displayed, rerun test.
  10. Return to foldout.
-

---

**A6 MODULE DIAGNOSTICS**

---

**Condition 3**

1. Set instrument to operating condition which causes A6 failure.
2. Record instrument set-up and error message(s).
3. Return to foldout.

**A6 MODULE DIAGNOSTICS**

Type:	Additional Substitute	<b>A6.06</b>
Run time:	A6 Tests	
Set-up time:	Conditional	

Test operation of substitute A6 Module by repeating test(s) performed on A6 Module before substitution.

- Condition 1: Instrument Level Self Test indicated A6 failure.
- Condition 2: RF Power Test for another module indicated A6 failure.
- Condition 3: Instrument must be set to a specific operating condition to detect A6 failure.

Condition 1

1. **INSTR PRESET** **SHIFT**  
(Hold shift key until "100.000000MZ -140.0DM" appears, to override 20 second reset test.
2. **SHIFT** **SPCL** **3** **3** **0** **HZ**.
3. When "WAITING FOR SET-UP 1 .V24" appears:
  - Connect BNC Tee connector, from On-Site Service Kit, to "FM/ΦM INPUT" (see INSTRUMENT LEVEL DIAGNOSTICS foldout for set-up diagram).
  - Connect a coax cable from Tee connector to "MOD OUTPUT".
  - Connect a coax cable from Tee to "AM/PULSE INPUT".
4. When "DIAG DONE HIT MSSGS .VI" appears:
  - Use **MSSG** to scroll through messages.
  - Record A6 error codes.

**COMMENT**

*If any error codes are displayed for modules A01, A03 or A04, you need to isolate those failure(s) now.*

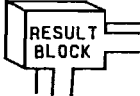
5. Return to foldout.
  - Determine next task by comparing test results to conditions shown in each  for TEST SUB A6 FURTHER.

**A6 MODULE DIAGNOSTICS**

---

**Condition 2**

1.    
 (Hold shift key until "100.00000MZ -140.0DM" appears, to override 20 second reset test.)
2.
3. When "WAITING FOR SET-UP 1 .V24" appears:
  - Disconnect cable W28 from module at A6A2 J8.
  - Connect YELLOW PM cable to module at A6A2 J8.
  - to continue test.
4. When "WAITING FOR SET-UP 2 .V25" appears:
  - Reconnect cable W28 to module at A6A2 J8.
  - Disconnect cable W26 from module at A6A2 J6.
  - Connect PM cable to module at A6A2 J6.
  - to continue test.
5. When "WAITING FOR SET-UP 3 .V26" appears:
  - Reconnect cable W26 to module at A6A2 J6.
  - Disconnect cable W29 from module at A6A2 J9.
  - Connect PM cable to module at A6A2 J9.
  - to continue test.
6. When "WAITING FOR SET-UP 4 .V27" appears:
  - Reconnect cable W29 to module at A6A2 J9.
  - Disconnect cable W23 from module at A6A2 J5.
  - Connect PM cable to module at A6A2 J5.
  - to continue test.
7. When "WAITING FOR SET-UP 5 .V28" appears:
  - Reconnect cable W23 to module at A6A2 J5.
  - Disconnect cable W24 from module at A6A1 J2.
  - Connect PM cable to module at A6A1 J2.
  - to continue test.
8. When "RECONNECT ALL CABLES .V29" appears:
  - Reconnect cable W24 to module at A6A1 J2.
  - to continue test.
9. When "DIAG DONE HIT MSSGS .V1" appears:
  - Use  to scroll through messages.
  - Record error code(s) displayed for A6. If "TEST 2A OF A06 (PASSED or FAILED)" is not displayed, rerun test.)
10. Return to foldout:
  - Determine next task by comparing test results to conditions shown in each **FURTHER.**

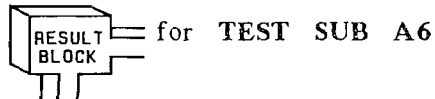

---

**A6 MODULE DIAGNOSTICS**

---

**Condition 3**

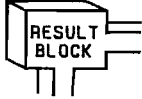
1. Set instrument to operating condition which causes A6 failure.
2. Record instrument set-up and error message(s).
3. Return to foldout:
  - Determine next task by comparing test results to conditions shown in each  for TEST SUB A6 FURTHER.

---

**A6 MODULE DIAGNOSTICS**

---

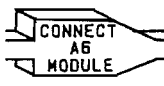
Type:	Cable Connection	A6.07
Run time:	0	
Set-up time:	5 min.	

**Connect Module**

1. Switch instrument to Standby.
2. Disconnect cables **W1, W20, W21, W23, W24, W26, W27, W28** and **W29** from substitute A6 Module.



*When connecting ribbon cable, find arrowhead on cable connector and align with arrowhead on board connector.*

3. Reconnect cables **W1, W20, W21, W23, W24, W26, W27, W28** and **W29** to A6 Module.
4. Turn instrument on.
5. Return substitute A6 Module to On-Site Service Kit.
6. Return to foldout.

---

**A6 MODULE DIAGNOSTICS**

---

Type:	3; Bit Transmission	<b>A 6.08</b>
Run time:	3 min.	
Set-up time:	2 min.	

Internal Voltmeter (VM) is used to measure TTL level changes transmitted to **A6 Module** on Clock, Data and Control lines.

**COMMENT**

*If any control line level is bad, it is not necessary to test remaining lines; proceed to step 34.*

**Run Test**

1. Switch instrument to **Standby**:
  - Disconnect cable **W1** from module at **A6A1 J1**.
  - Plug end of **W1** into **26 pin** test connector, from On-Site Service Kit.

**NOTE**

*Find arrowhead on test connector and align with arrowhead on cable plug **W1P2**.*

**CAUTION**

*To prevent damage to the Power Supply and Control sections, do not permit the exposed pins on the test connector to short circuit.*

2. Connect **VM** probe:
    - Connect red alligator clip and retractable hook probe to red test lead provided in On-Site Service Kit.
    - Connect alligator clip to **VM IN (A4TP1)**. (See **A6 MODULE CABLE CONNECTION LOCATOR** on fold-out for **VM IN** location.)
  3. Turn instrument on.
-

**A6 MODULE DIAGNOSTICS**

**FM Control Lines**

**Check High State**

4. **SHIFT** **SPCL** **3** **6** **0** **2**  
 (To specify high state.)

**NOTE**

*A "0" will appear in display indicating that these data bits will be set low. However, the bits are inverted in the Control Section before they are sent to A6.*

5. Enter **Bit Select Keys**, as indicated in **Table 3F-1. W1P2 Control Bits**, for **Control Line** to be tested.
6. Connect **VM** probe to **Control Line** at **Pin Number** indicated in **Table 3F-1. (See Figure 3F-1. Cable Plug W1P2 Signal Locator.)**

**Table 3F-1. W1P2 Control Bits**

Test Order	Control Line	Bit Select Keys (Steps 5 and 10)	Pin Number (Step 6)
1	FM CLK	<b>4</b> <b>6</b> <b>HZ</b>	23
2	FM DATA	<b>4</b> <b>7</b> <b>HZ</b>	25

**Figure 3F-1. Cable Plug W1P2 Signal Locator**

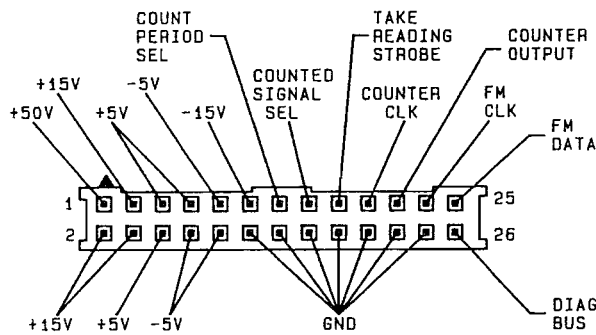



---

**A6 MODULE DIAGNOSTICS**

---

7.     
(To enable voltmeter.)
8. Voltage should read approximately **+2.5** to **+5.5** Vdc.  
(  to repeat measurement.)

**Check Low State**

9.        
(To specify low state.)

**NOTE**

*A "1" will appear in display indicating that these data bits will be set high. However, the bits are inverted in the Control Section before they are sent to A6.*

10. Enter **Bit Select Keys**, as indicated in **Table 3F-1**, for same **Control Line**.
11.     
(To enable voltmeter.)
12. Voltage should read approximately **-0.5** to **+1.5** Vdc.  
(  to repeat measurement.)
13. Repeat procedure for each **Control Line** shown in **Table 3F-1** before proceeding to step **14**.

**Counter Control Lines****Check High State**

14.        
(To specify high state.)
  15. Enter **Bit Select Keys**, as indicated in **Table 3F-2**. **W1P2** **Control Bits**, for **Control Line** to be tested.
  16. Connect **VM** probe to **Control Line** at **Pin Number** indicated in **Table 3F-2**. (See **Figure 3F-1**. **Cable Plug W1P2** **Signal Locator**.)
-

---

**A6 MODULE DIAGNOSTICS**

---

Table 3F-2. W1P2 Control Bits

Test Order	Control Line	Bit Select Keys (Steps 15 and 20)	Pin Number (Step 16)
1	COUNTER CLK	[7] [2] [HZ]	19
2	TAKE READING STROBE	[7] [3] [HZ]	17
3	COUNT PERIOD SELECT	[7] [4] [HZ]	13
4	COUNTED SIGNAL SELECT	[7] [5] [HZ]	15

17. [2] [5] [HZ]  
(To enable voltmeter.)
18. Voltage should read approximately +2.5 to +5.5 Vdc.  
[5] [HZ] to repeat measurement.)

**Check Low State**

19. [SHIFT] [SPCL] [3] [6] [0] [2]  
(To specify low state.)
20. Enter **Bit Select Keys**, as indicated in **Table 3F-2**, for same **Control Line**.
21. [2] [5] [HZ]  
(To enable voltmeter.)
22. Voltage should read approximately -0.5 to +1.5 Vdc.  
[5] [HZ] to repeat measurement.)
23. Repeat procedure for each **Control Line** shown in **Table 3F-2** before proceeding to step 24.
-

---

**A6 MODULE DIAGNOSTICS**

---

24. Switch instrument to Standby:
- Disconnect **W1** from module at **A6A2 J1**.
  - Plug end of **W1** into **14 pin** test connector, from On-Site Service Kit, into end of **W1**. (See Figure 3F-2. Cable Plug **W1P3** Signal Locator.)

**NOTE**

*Find arrowhead on test connector and align with arrowhead on cable plug **W1P3**.*

- Turn instrument on.

**Timebase Control Line****Check High State**

25.        
(To specify high state.)
26.     
(To select bit.)
27. Connect **VM** probe to test connector at **TIMEBASE DISABLE** (pin 8). (See Figure 3F-2. Cable Plug **W1P3** Signal Locator.)

**Figure 3F-2. Cable Plug W1P3 Signal Locator**

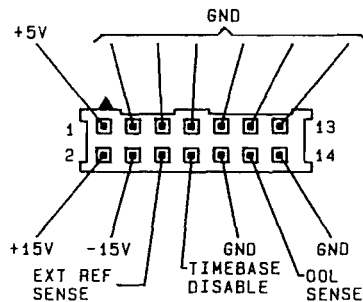

28.     
(To enable voltmeter.)
29. Voltage should read approximately **+2.5 to +5.5 Vdc**.  
(  to repeat measurement.)
-

---

**A6 MODULE DIAGNOSTICS**

---

**Check Low State**

30.        
 (To specify low state.)
31.     
 (To select bit.)
32.     
 (To enable voltmeter.)
33. Voltage should read approximately **-0.5 to +1.5 Vdc.**  
  to repeat measurement.)
34. Record test results.
35. Return to foldout:  
 • Determine next task by comparing test results to conditions shown in each **RESULT BLOCK** for **TEST CONTROL BITS.**

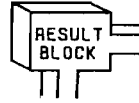

---

**A6 MODULE DIAGNOSTICS**

---

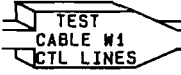
Type:	3; Bit Transmission	<b>A6.09</b>
Run time:	3 min.	
Set-up time:	3 min.	

Internal Voltmeter (VM) is used to measure TTL level changes transmitted to **A6 Module** on Clock, Data and Control lines.

**Run Test**

1. Switch instrument to **Standby**.
2. Extend **A6 Module** on extender posts, from On-Site Service Kit, and disconnect cable **W1** from **A5 Module** at **A5J1**. (Refer to table on foldout in **MECHANICAL PROCEDURES** to locate **A6 Module** extension and **A5** cable disconnection information.)
3. Connect **VM** probe:
  - Connect red alligator clip and pointed tip probe to red test lead provided in On-Site Service Kit.
  - Connect alligator clip to **VM IN (A4TP1)**. (See **A6 MODULE CABLE CONNECTION LOCATOR** on fold-out for **VM IN** location.)
4. Turn instrument on.

**COMMENT**

*It is only necessary to perform test on failing control line.*

---

**A6 MODULE DIAGNOSTICS**

**FM Control Lines**

**Check High State**

5.        
 (To specify high state.)

**NOTE**

A "0" will appear in display indicating that these data bits will be set low. However, the bits are inverted in the Control Section before they are sent to A6.

6. Enter Bit Select Keys, as indicated in Table 3F-3. A5J1 Control Bits, for Control Line to be tested.
7. Connect VM probe to Control Line at Pin Number indicated in Table 3F-3. (See Figure 3F-3. A5J1 Signal Locator.)

**Table 3F-3 A5J1 Control Bits**

Test Order	Control Line	Bit Select Keys (Steps 6 and 11)	Pin Number (Step 7)
1	FM CLK	<input type="text" value="4"/> <input type="text" value="6"/> <input type="text" value="HZ"/>	18
2	FM DATA	<input type="text" value="4"/> <input type="text" value="7"/> <input type="text" value="HZ"/>	16

**Figure 3F-3. A5J1 Signal Locator  
(Solder-Side View)**

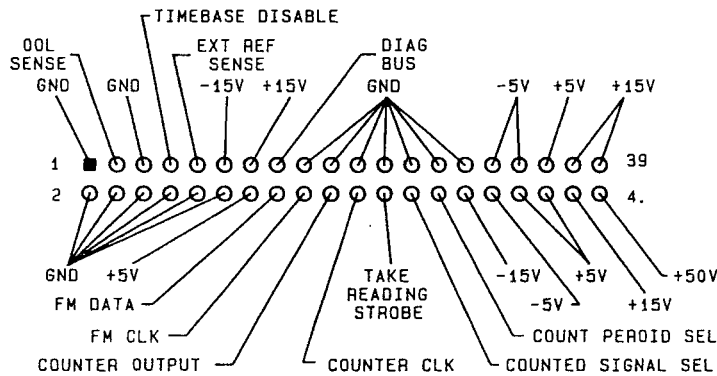

---

**A6 MODULE DIAGNOSTICS**

---

8.     
(To enable voltmeter.)
9. Voltage should read approximately **+2.5 to +5.5 Vdc**.  
  to repeat measurement.)

**Check Low State**

10.        
(To specify low state.)

**NOTE**

*A "1" will appear in display indicating that these data bits will be set high. However, the bits are inverted in the Control Section before they are sent to A6.*

11. Enter **Bit Select Keys**, as indicated in **Table 3F-3**, for same **Control Line**.
12.     
(To enable voltmeter.)
13. Voltage should read approximately **-0.5 to +1.5 Vdc**.  
  to repeat measurement.)

**Counter/Timebase Control Lines****Check High State**

14.        
(To specify high state.)
  15. Enter **Bit Select Keys**, as indicated in **Table 3F-4**. **A5J1 Control Bits**, for **Control Line** to be tested.
  16. Connect **VM** probe to **Control Line** at **Pin Number** indicated in **Table 3F-4**. (See **Figure 3F-3**. **A5J1 Signal Locator**.)
-

---

**A6 MODULE DIAGNOSTICS**

---

Table 3F-4. A5J1 Control Bits

Test Order	Control Line	Bit Select Keys (Steps 15 and 20)	Pin Number (Step 16)
1	COUNTER CLK	<input type="checkbox"/> 7 <input type="checkbox"/> 2 <input type="checkbox"/> HZ	22
2	TAKE READING STROBE	<input type="checkbox"/> 7 <input type="checkbox"/> 3 <input type="checkbox"/> HZ	24
3	COUNT PERIOD SELECT	<input type="checkbox"/> 7 <input type="checkbox"/> 4 <input type="checkbox"/> HZ	28
4	COUNTED SIGNAL SELECT	<input type="checkbox"/> 7 <input type="checkbox"/> 5 <input type="checkbox"/> HZ	26
5	TIMEBASE DISABLE	<input type="checkbox"/> 1 <input type="checkbox"/> 4 <input type="checkbox"/> HZ	7

17.  2  5  HZ  
(To enable voltmeter.)
18. Voltage should read approximately +2.5 to +5.5 Vdc.  
( 5  HZ) to repeat measurement.)

**Check Low State**

19.  SHIFT  SPCL  3  6  0  2  
(To specify low state.)
20. Enter Bit Select Keys, as indicated in Table 3F-4, for same Control Line.



---

**A6 MODULE DIAGNOSTICS**

---

21.  2  5  HZ  
(To enable voltmeter.)
22. Voltage should read approximately **-0.5 to +1.5 Vdc**.  
( 5  HZ to repeat measurement.)
23. Repeat procedure for each Control Line shown in Table 3F-4.
24. Record test results.
25. Return to foldout:
  - Determine next task by comparing test results to conditions shown in each **RESULT BLOCK** for **TEST CABLE W1 CTL LINES**.

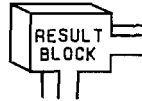

---

**A6 MODULE DIAGNOSTICS**

---

Type:	4, Voltage Measurements	<b>A6.10</b>
Run time:	2 min.	
Set-up time:	2 min.	

Internal Voltmeter (VM) is used to check power supply levels at inputs to A6 Module.

**Run Test**

- Switch instrument to Standby:
  - Disconnect W1 from A6 at A6A1 J1.
  - Plug end of W1 into 26 pin test connector, from On-Site Service Kit.

**NOTE**

*Find arrowhead on test connector and align with arrowhead on cable plug W1P2.*

- Connect VM probe:
  - Connect red alligator clip and retractable hook probe to red test lead provided in On-Site Service Kit.
  - Connect alligator clip to VM IN (A4TP1). (See A6 MODULE CABLE CONNECTION LOCATOR on fold-out for VM IN location.)
- Turn instrument on and enter:  
 [SHIFT] [SPCL] [3] [2] [5] [HZ]  
 (To enable Internal Voltmeter.)

---

**A6 MODULE DIAGNOSTICS**

---

4. Measure voltage levels:
  - Connect VM probe to test connector pin for each power supply line. (See Figure 3F-3. Cable Plug W1P2 Signal Locator.)
  - (To make each voltage measurement.)

Figure 3F-3. Cable Plug W1P2 Signal Locator

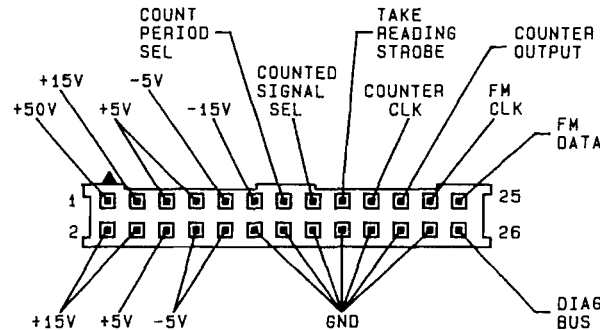

5. Switch instrument to Standby:
  - Disconnect W1 from A6 at A6A2 J1.
  - Plug end of W1 into 14 pin test connector, from On-Site Service Kit.

**NOTE**

*Find arrowhead on test connector and align with arrowhead on cable plug W1P3.*

6. Measure voltage levels:
    - Connect VM probe to test connector pin for each power supply line. (See Figure 3F-4. Cable Plug W1P3 Signal Locator.)
    - (To make each voltage measurement.)
-

**A6 MODULE DIAGNOSTICS**

---

Figure 3F-4. Cable Plug W1P3 Signal Locator

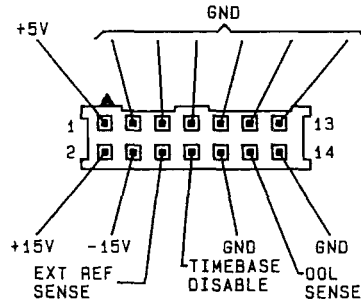

7. Record test results.
8. Return to foldout:
  - Determine next task by comparing test results to conditions shown in each

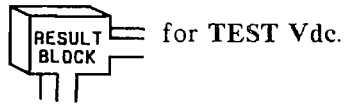

for TEST Vdc.

---

**A6 MODULE DIAGNOSTICS**

---

Type:	4, Voltage Measurements	A6.11
Run time:	2 min.	
Set-up time:	3 min.	

Internal Voltmeter (VM) is used to check power supply levels at A5J1.

### Run Test

1. Switch instrument to **Standby**.
2. Extend **A6 Module** on extender posts, from On-Site Service Kit, and disconnect cable **W1** from **A5 Module** at **A5J1**. (Refer to table on foldout in **MECHANICAL PROCEDURES** to locate **A6 Module** extension and **A5** cable disconnection information.)
3. Connect **VM** probe:
  - Connect red alligator clip and pointed tip probe to red test lead provided in On-Site Service Kit.
  - Connect alligator clip to **VM IN (A4TP1)**. (See **A6 MODULE CABLE CONNECTION LOCATOR** on foldout for **VM IN** location.)
4. Turn instrument on and enter:  
 [SHIFT] [SPCL] [3] [2] [5] [HZ]  
 (To enable Internal Voltmeter.)

**A6 MODULE DIAGNOSTICS**

5. Measure voltage levels at A5J1:
  - Access signals from solder-side of A5J1. (See Figure 3F-5. A5J1 Signal Locator.)
  - **5** **HZ** (To make each voltage measurement.)

Figure 3F-5. A5J1 Signal Locator  
(Solder-Side View)

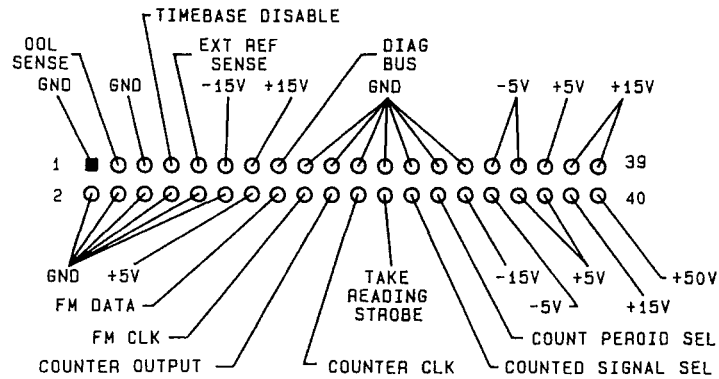

6. Record test results.
7. Return to folout:
  - Determine next task by comparing test results to conditions shown in each **RESULT BLOCK** for **TEST CABLE W1 PS LINES**.

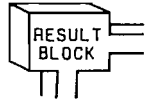

---

**A6 MODULE DIAGNOSTICS**

---

Type:	External Reference Check	A6.12
Run Time:	10 sec.	
Set-up Time:	0	

**Run Test**

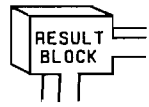
1.    
 (Hold shift key until "100.000000MZ -140.0DM" appears, to override 20 second reset test.)
2.      .
3. Record test results.
4. Return to foldout:
  - Determine next task by comparing test results to conditions shown in each  for TEST EXT. REF.

**A6 MODULE DIAGNOSTICS**

---

Type:	1; Loop Lock/Unlock	A6.13
Run Time:	1 min.	
Set-up Time:	0	

**Run Test**

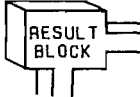
1. Disconnect external reference from Rear Panel at **EXT REF INPUT (J4)**.
2. **INSTR PRESET** **SHIFT**  
 (Hold shift key until "100.000000MZ -140.0DM" appears, to override 20 second reset test.)
3. **SHIFT** **SPCL** **3** **3** **2** **0** **HZ**.
4. When "**DIAG DONE HIT MSSG .V1**" appears:
  - Use **MSSG** to scroll through messages.
  - Record error code(s) displayed for A6. If "**TEST 1 OF A06 (PASSED or FAILED)**" is not displayed, rerun test.
5. Return to foldout:
  - Determine next task by comparing test results to conditions shown in each  for **TEST LOOP**.

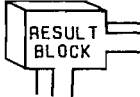



---

**A6 MODULE DIAGNOSTICS**

---

Type:	External Reference	A6.14
Run time:	N/A	
Set-up time:	N/A	

Test results indicate that the external reference signal is not stable enough for the **A6 Module** to lock to.

1. Use another reference source if available or operate instrument unreferenced.
2. Return to foldout and proceed as directed to confirm correct operation of the rest of instrument.

---

**A6 MODULE DIAGNOSTICS**

---

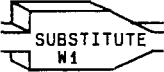
<b>Type:</b>	Cable Substitution	<b>A6.15</b>
<b>Run time:</b>	0 min.	
<b>Set-up time:</b>	4 min.	

Testing has shown cable **W1** to be suspect, temporarily replace with a spare ribbon cable if available. Rerun **INSTRUMENT LEVEL DIAGNOSTICS (ILD)** to confirm repair.

Refer to **REPLACEABLE PARTS**, in HP 8642A/B Operating and Service Manual, for information to order a permanent replacement cable.

**NOTE**

*Cable **W1** is a single cable which splits and connects both **A6A1 J1** and **A6A2 J1** to **A5J1**.*

**CAUTION**

*When connecting ribbon cable to A6 Module, find arrowhead on the cable plug and align with arrowhead on the board connector.*

**Reconnect W1**

1. Switch instrument to **Standby** to connect cable **W1** to **A5 Module** and **A6 Module**. (Refer to table on foldout in **MECHANICAL PROCEDURES** for information on connecting cable **W1** to **A5J1**.)
2. Return to foldout.

---

**A6 MODULE DIAGNOSTICS**

---

Type:	Cable Connection	A6.16
Run time:	0 min.	
Set-up time:	4 min.	

**CAUTION**

*When connecting ribbon cable to A6 Module, find arrowhead on the cable plug and align with arrowhead on the board connector.*

**Reconnect W1**

1. Switch instrument to **Standby** to reconnect cable **W1** to **A5 Module** or **A6 Module**. (Refer to table on foldout in **MECHANICAL PROCEDURES** for information on reconnecting cable **W1** to **A5J1**.)
2. Return to foldout.

---

## A6 THEORY OF OPERATION

---

### 3F-4. A6 FM/COUNTER/TIMEBASE MODULE

#### COMMENT

*It is not to essential to understand the internal operation of a module to make an on-site repair.*

#### A6 FM LOOP

The **A6 FM Loop** is the angle modulation source for the instrument. A **135 MHz** voltage controlled oscillator (VCO), phase locked to the timebase, can be either frequency or phase modulated by the audio signal sent from the **A2 Module**.

For **DCFM** operation, the VCO tune path is switched to a stable DC voltage source within the **A6 Module**.

The **A6 FM LOOP OUTPUT** is the reference signal for the **A11 Module**.

#### A6 TIMEBASE

The **A6 Timebase** provides the timebase reference for the instrument. In normal operation, the various timebase signals required for operation are derived from a free running **45 MHz** oscillator.

For improved stability, the **45 MHz** oscillator can be phase locked to an external source (**1, 2, 5, or 10 MHz**) or to the **10 MHz** signal provided by the **A8 High Stability Timebase Module** (installed in Option **001** instruments).

#### A6 COUNTER

The **A6 Counter** counts audio frequencies produced by the internal modulation source in the **A2 Module**. The counter output is sent to the instrument's **Control Section** which provides the tune control for **A2's** audio oscillator.

Audio frequencies **greater** than **10 kHz** are counted directly. The Timebase output signal is divided and used as the gate clock.

Audio frequencies **below** **10 kHz** are counted indirectly. The audio signal is used as the gate clock to count the **45 MHz** timebase signal.

The counter also counts the frequency of the **FM Loop**, when it is in **DCFM** mode.

See the **A6 MODULE SIMPLIFIED BLOCK DIAGRAM** for further understanding of the **A6 Module's** internal operation.

---

A6 MODULE SIMPLIFIED BLOCK DIAGRAM

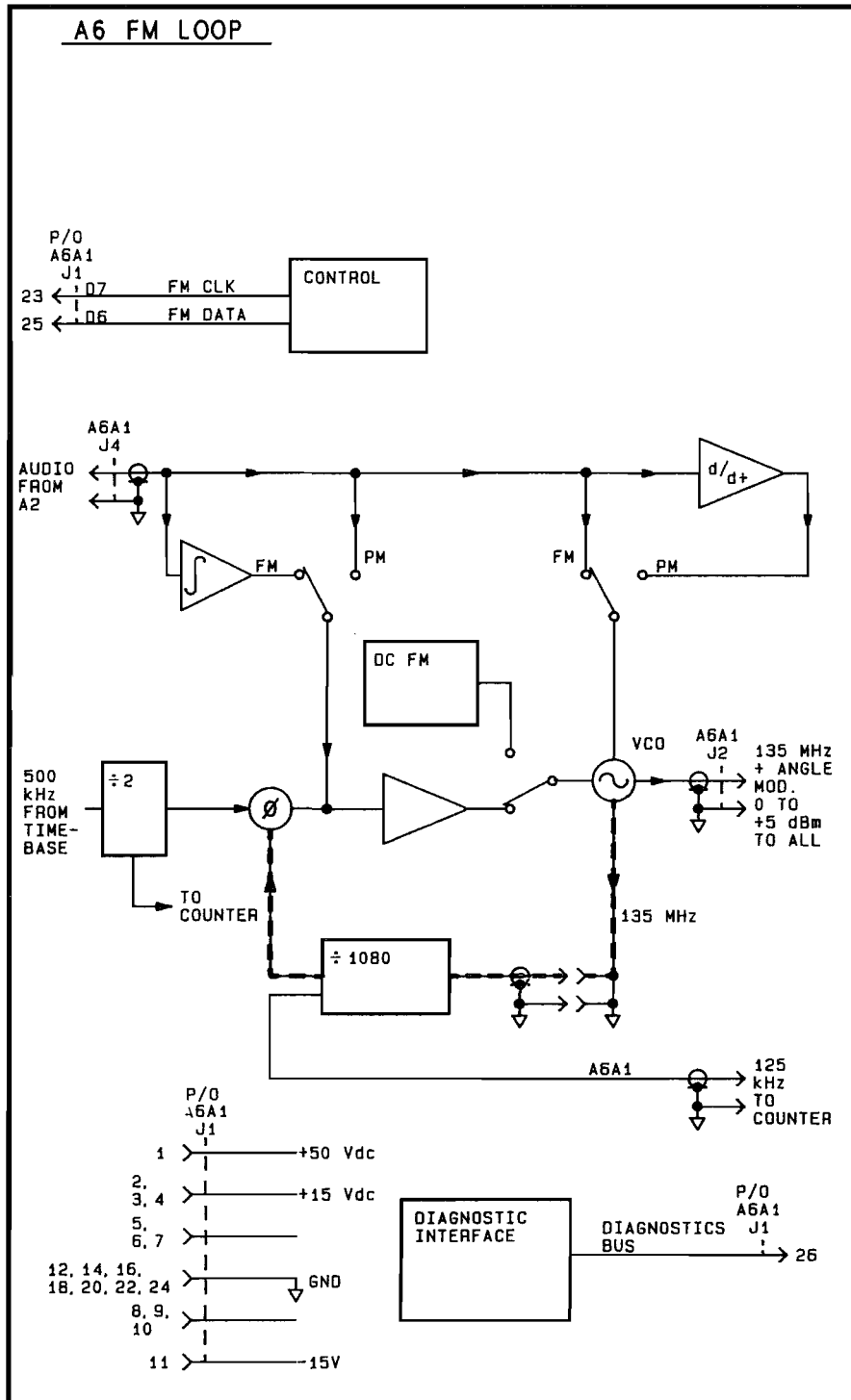

---

## A7 SAWR LOOP MODULE

---

### 3G-1. INTRODUCTION

The **MODULE LEVEL DIAGNOSTICS (MLD)** contained in this section are used to further interrogate the **A7 Module**. The objective is to isolate the failure indicated for this module to the module itself or to a part on which it depends for operation.

#### NOTE

*At this level of testing, recommendations for further action are made on the assumption that the **INSTRUMENT LEVEL DIAGNOSTICS (ILD)** showed no failures for modules **A01-A06**. (For information on using the on-site diagnostics, refer to the **INTRODUCTION** section of this manual.)*

#### CAUTION

*When tightening the coax cable connectors, do not exceed a torque of 1.0 Nm or .74 ft-lbs (slightly tighter than finger tight).*

*When coax cables are disconnected from instrument, do not allow loose ends to come in contact with any exposed circuitry susceptible to short circuiting.*

#### Test Instructions

1. The instrument's **Top Cover** must be removed to run many of these tests. (Refer to table on foldout in **MECHANICAL PROCEDURES** to locate instructions.)
2. The last page in this group of tests is a foldout and should be pulled out now.
3. Turn to the next page to begin the **A7 MLD**.

---

## A7 MODULE SUBSTITUTION

---

### 3G-2. INTRODUCTION

#### NOTE

*If a known good module is not available, proceed to the next page, A7 INPUTS VERIFICATION.*

The first step in isolating an A7 failure is to substitute in a known good module from the On-site Service Kit.

#### A7 Substitution Instructions

1. Find **A7 MODULE SUBSTITUTION** on the foldout.
2. Use the Task Sequence Diagram, shown under **A7 MODULE SUBSTITUTION**, to direct you through the substitution process. Each Task Arrow shown in the diagram indicates a task title and task number. The tasks are numbered according to the order in which they are arranged in this section. Turn to the task indicated and complete the procedure.
3. After completing the procedure, return to the Task Sequence Diagram on the foldout and determine the next task to be performed.
4. Begin now by performing the first task shown on the diagram.

---

## A7 INPUTS VERIFICATION

---

### 3G-3. INTRODUCTION



If a known good A7 Module is not available or, if you were not able to isolate the failure using the **A7 MODULE SUBSTITUTION** procedure, the Task Sequence Diagrams (shown under **A7 INPUTS VERIFICATION**) should be used to check each signal path into the A7 Module.

#### A7 Inputs Verification Instructions

1. Find **A7 INPUTS VERIFICATION** on the foldout.
2. The Task Sequence Diagrams, shown under **A7 INPUTS VERIFICATION**, are separated into three checks: **RF**, **Control** and **Power Supply** signals.
3. Use the Task Sequence Diagrams to direct you through the verification process. Each Task Arrow shown in a diagram indicates a task title and task number. The tasks are numbered according to the order in which they are arranged in this section. Turn to the task indicated and complete the procedure.
4. After completing the procedure, return to the Task Sequence Diagram on the foldout and determine the next task to be performed.
5. Begin now by performing the first task shown under **1. A7 RF INPUT CHECK**.

#### NOTE

*The **A7 MODULE I/O SIGNALS DIAGRAM** shows all parts which the A7 Module depends on for operation.*



---

**A7 MODULE DIAGNOSTICS**

---

Type:	1; Loop Lock/Unlock	<b>A 7.02</b>
Run time:	1 min.	
Set-up time:	0	

**Run Test**

1. **INSTR PRESET** **SHIFT**  
(Hold shift key until "100.000000MZ -140.0DM" appears, to override 20 second reset test.)
2. **SHIFT** **SPCL** **3** **3** **2** **5** **HZ**.
3. When "DIAG DONE HIT MSG.V1" appears:
  - Use **MSSG** to scroll through messages.
  - Record error code(s) displayed for **A7**. If "TEST 1 OF A07 (PASSED or FAILED)" is not displayed, rerun test.

**COMMENT**

*If any error codes are displayed for modules A01-A06, you need to isolate those failure(s) before performing the A7 MODULE SUBSTITUTION. (Refer to INSTRUMENT LEVEL DIAGNOSTICS to determine correct order for troubleshooting modules.)*

4. Return to foldout:
  - Determine next task by comparing test results to conditions shown in each  for **TEST A7 MODULE**.

---

**A7 MODULE DIAGNOSTICS**

---

<b>Type:</b>	Module Substitution	<b>A7.03</b>
<b>Run time:</b>	0	
<b>Set-up time:</b>	5 min.	

The following describes the technique for connecting a known good A7 Module without removing the A7 module in the instrument.

**Connect Substitute Module**

1. Switch instrument to **Standby**.
2. Disconnect cables **W2**, **W25** and **W28** from **A7 Module** (see **A7 MODULE CABLE CONNECTION LOCATOR** on foldout).
3. Without removing **A7 Module** from instrument, carefully lay substitute **A7 Module** on top of modules **A9**, **A11** and **A12**.

CAUTION

*When connecting ribbon cable, find arrowhead on cable connector and align with arrowhead on board connector.*

4. Connect cables **W2**, **W25** and **W28** to substitute module.
  5. Turn instrument on.
  6. Return to foldout.
-

---

**A7 MODULE DIAGNOSTICS**

---

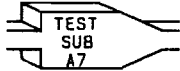
Type:	Substitute Module Test	A7.04
Run time:	1 min.	
Set-up time:	0	

Test operation of substitute A7 Module by repeating test performed on A7 Module before substitution.

**Run Test**

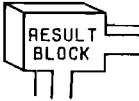
1. **INSTR PRESET** **SHIFT**  
(Hold shift key until "100.000000MZ -140.0DM" appears, to override 20 second reset test.)
2. **SHIFT** **SPCL** **3** **3** **2** **5** **HZ**.
3. When "DIAG DONE HIT MSSG .V1" appears:
  - Use **MSSG** to scroll through messages.
  - Record error code(s) displayed for A7. If "TEST 1 OF A07 (PASSED or FAILED)" is not displayed, rerun test.
4. Return to foldout:
  - Determine next task by comparing test results to conditions shown in each  for TEST SUB A7.

**A7 MODULE DIAGNOSTICS**

---

Type:	Additional A7 Tests	<b>A7.05</b>
Run time:	Conditional	
Set-up time:	Conditional	

The A7 failure conditions for arriving at this task are described below. Follow the procedure for the condition which fits your module.

- Condition 1: Instrument Level Self Test indicated A7 failure.
- Condition 2: A11 Module RF Power Test indicated A7 failure.
- Condition 3: Instrument must be set to a specific operating condition to detect A7 failure.

Condition 1

1.    
 (Hold shift key until "100.000000MZ -140.0DM" appears, to override 20 second reset test.)
2.      .
3. When "WAITING FOR SET-UP 1 .V24" appears:
  - Connect BNC Tee connector, from On-Site Service Kit, to "FM/ΦM INPUT" (see INSTRUMENT LEVEL DIAGNOSTICS foldout for set-up diagram).
  - Connect a coax cable from Tee connector to "MOD OUTPUT".
  - Connect a coax cable from Tee to "AM/PULSE INPUT"
4. When "DIAG DONE HIT MSSGS .VI" appears:
  - Use  to scroll through messages.
  - Record A7 error codes.

**COMMENT**

*If any error codes are displayed for modules A01-A06, you need to isolate those failure(s) before performing the A7 MODULE SUBSTITUTION. (Refer to INSTRUMENT LEVEL DIAGNOSTICS to determine correct order for troubleshooting modules.)*

5. Return to foldout.
-

---

**A7 MODULE DIAGNOSTICS**

---

**Condition 2**

1. **INSTR PRESET** **SHIFT**  
(Hold shift key until "100.000000MZ -140.0DM" appears, to override 20 second reset test.)
2. **SHIFT** **SPCL** **3** **3** **2** **6** **HZ**
3. When "WAITING FOR SET-UP 1 .V24" appears:
  - Disconnect cable **W28** from module at **A7A1 J2**.
  - Connect **YELLOW PM** cable and adapter to cable **W28**.
  - **HZ** to continue test.
4. When "WAITING FOR SET-UP 2 .V25" appears:
  - Reconnect cable **W28** to module at **A7A1 J2**.
  - Disconnect cable **W25** from module at **A7A1 J3**.
  - Connect **PM** cable to module at **A7A1 J3**.
  - **HZ** to continue test.
5. When "RECONNECT ALL CABLES .V29" appears:
  - Reconnect cable **W25** to module at **A7A1 J3**.
  - **HZ** to continue test.
6. When "DIAG DONE HIT MSSGS .V1" appears:
  - Use **MSSG** to scroll through messages.
  - Record error code(s) displayed for **A7**. If "TEST 2A OF A07 (PASSED or FAILED)" is not displayed, rerun test.
7. Return to foldout.

**Condition 3**

1. Set instrument to operating condition which causes **A7 failure**.
  2. Record instrument set-up and error message(s).
  3. Return to foldout.
-

**A7 MODULE DIAGNOSTICS**

Type:	Additional Substitute A7 Tests	
Run time:	Conditional	
Set-up time:	Conditional	

Test operation of substitute A7 Module by repeating test(s) performed on A7 Module before substitution.

- Condition 1: Instrument Level Self Test indicated A7 failure.
- Condition 2: A11 Module RF Power Test indicated A7 failure.
- Condition 3: Instrument must be set to a specific operating condition to detect A7 failure.

**Condition 1**

1. **INSTR PRESET** **SHIFT**  
(Hold shift key until "100.000000MZ -140.0DM" appears, to override 20 second reset test.)
2. **SHIFT** **SPCL** **3** **3** **0** **HZ**.
3. When "WAITING FOR SET-UP 1 .V24" appears:
  - Connect BNC Tee connector, from On-Site Service Kit, to "FM/ΦM INPUT" (see INSTRUMENT LEVEL DIAGNOSTICS foldout for set-up diagram).
  - Connect a coax cable from Tee connector to "MOD OUTPUT".
  - Connect a coax cable from Tee to "AM/PULSE INPUT"
4. When "DIAG DONE HIT MSSGS .VI" appears:
  - Use **MSSG** to scroll through messages.
  - Record A7 error codes.

**COMMENT**

*If any error codes are displayed for modules A01-A06, you need to isolate those failure(s) now.*

5. Return to foldout.
  - Determine next task by comparing test results to conditions shown in each **FURTHER**.

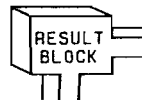

for TEST SUB A7

---

**A7 MODULE DIAGNOSTICS**

---

**Condition 2**

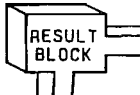
1. **INSTR PRESET** **SHIFT**  
(Hold shift key until "100.000000MZ -140.0DM" appears, to override 20 second reset test.)
2. **SHIFT** **SPCL** **3** **3** **2** **6** **HZ**
3. When "WAITING FOR SET-UP 1 .V24" appears:
  - Disconnect cable **W28** from module at **A7A1 J2**.
  - Connect **YELLOW PM** cable and adapter to cable **W28**.
  - **HZ** to continue test.
4. When "WAITING FOR SET-UP 2 .V25" appears:
  - Reconnect cable **W28** to module at **A7A1 J2**.
  - Disconnect cable **W25** from module at **A7A1 J3**.
  - Connect **PM** cable to module at **A7A1 J3**.
  - **HZ** to continue test.
5. When "RECONNECT ALL CABLES .V29" appears:
  - Reconnect cable **W25** to module at **A7A1 J3**.
  - **HZ** to continue test.
6. When "DIAG DONE HIT MSSGS .V1" appears:
  - Use **MSSG** to scroll through messages.
  - Record error code(s) displayed for **A7**. If "TEST 2A OF A7 (PASSED or FAILED)" is not displayed, rerun test.)
7. Return to foldout:
  - Determine next task by comparing test results to conditions shown in each  for **TEST SUB A7 FURTHER**.

**Condition 3**

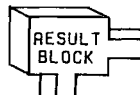
1. Set instrument to operating condition which causes **A7 failure**.
  2. Record instrument set-up and error message(s).
  3. Return to foldout:
    - Determine next task by comparing test results to conditions shown in each  for **TEST SUB A7 FURTHER**.
-

---

**A7 MODULE DIAGNOSTICS**

---

Type:	Cable Connection	A7.07
Run time:	0	
Set-up time:	5 min.	

**Connect Module**

1. Switch instrument to **Standby**.
2. Disconnect cables **W2**, **W25** and **W28** from substitute **A7 Module**.

**CAUTION**

*When connecting ribbon cable, find arrowhead on cable connector and align with arrowhead on board connector.*

3. Reconnect cables **W2**, **W25** and **W28** to **A7 Module**.
4. Turn instrument on.
5. Return substitute **A7 Module** to On-Site Service Kit.
6. Return to foldout.



---

**A7 MODULE DIAGNOSTICS**

---

Type:	2A; RF Power Levels	<b>A7.08</b>
Run time:	30 sec.	
Set-up time:	2 min.	

RF signal level is measured using Internal Power Meter (PM).

CAUTION

*Do not permit end of Internal Power Meter cable to short circuit instrument by coming in contact with any exposed circuitry.*

**Run Test**

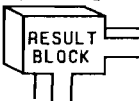
1. **INSTR PRESET** **SHIFT**  
(Hold shift key until "100.000000MZ -140.0DM" appears, to override 20 second reset test.)
2. **SHIFT** **SPCL** **3** **6** **8** **1** **2** **HZ**  
(To check input levels only.)
3. **3** **2** **6** **HZ**.
4. When "WAITING FOR SET-UP 1 .V24" appears:
  - Disconnect cable W28 from module at A7A1 J2.
  - Connect **YELLOW PM** cable and adapter to cable W28.
  - **HZ** to continue test.
5. When "RECONNECT ALL CABLES .V29" appears:
  - Reconnect cable W28 to module at A7A1 J2.
  - **HZ** to continue test.
6. When "DIAG DONE HIT MSSGS .V1" appears:
  - Use **MSSG** to scroll through messages.
  - Record error code(s) displayed for A7. If "TEST 2A OF A07 (PASSED or FAILED)" is not displayed, rerun test.
7. Return to foldout:
  - Determine next task by comparing test results to conditions shown in each  for **TEST RF POWER**.

---

**A7 MODULE DIAGNOSTICS**

---

Type:	2A; RF Power Levels	A 7.09
Run time:	30 sec.	
Set-up time:	2 min.	

RF signal level is measured using Internal Power Meter (PM).

**Run Test**

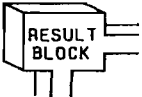
1.    
 Hold shift key until  
 "100.000000MZ -140.0DM" appears,  
 to override 20 second reset test.)
2.          
 (To check input levels only.)
3.
4. When "WAITING FOR SET-UP 1 .V24" appears:
  - Disconnect cable W28 from module at A6A2 J8. (See Top View Diagram inside Top Cover to locate W28 connection on A6 Module.)
  - Connect YELLOW PM cable to module at A6A2 J8.
  - to continue test.
5. When "RECONNECT ALL CABLES .V29" appears:
  - Reconnect cable W28 to module at A6A2 J8.
  - to continue test.
6. When "DIAG DONE HIT MSSGS .V1" appears:
  - Use  to scroll through messages.
  - Record error code(s) displayed for A7. If "TEST 2A OF A07 (PASSED or FAILED)" is not displayed, rerun test.
7. Return to foldout:
  - Determine next task by comparing test results to conditions shown in each  for TEST CABLE W28.

---

**A7 MODULE DIAGNOSTICS**

---

Type:	3; Bit Transmission	<b>A7.10</b>
Run time:	3 min.	
Set-up time:	2 min.	

Internal Voltmeter (VM) is used to measure TTL level changes transmitted to **A7 Module** on SAWR oscillator select lines **A** and **B**.

**Run Test**

- Switch instrument to **Standby**:
  - Disconnect cable **W2** from module at **A7A1 J1**.
  - Plug end of **W2** into **14** pin test connector, from On-Site Service Kit.

**NOTE**

*Find arrowhead on test connector and align with arrowhead on cable plug **W2P2**.*

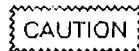

*To prevent damage to the Power Supply and Control sections, do not permit the exposed pins on the test connector to short circuit.*

- Connect VM probe:
  - Connect red alligator clip and retractable hook probe to red test lead provided in On-Site Service Kit.
  - Connect alligator clip to **VM IN (A4TP1)**. (See **A7 MODULE CABLE CONNECTION LOCATOR** on fold-out for **VM IN** location.)
- Turn instrument on.  
(Hold shift key until "**100.000000MZ -140.0DM**" appears, to override 20 second reset test.)

**SAWR Select Line A****Check High State**

- SHIFT** **SPCL** **3** **6** **0** **1**  
(To specify high state.)
  - 3** **0** **HZ**  
(To select bit.)
-

**A7 MODULE DIAGNOSTICS**

6. Connect VM probe to test connector line A (pin 10). (See Figure 3G-1. Cable Plug W2P2 Signal Locator.)

**Figure 3G-1. Cable Plug W2P2 Signal Locator**

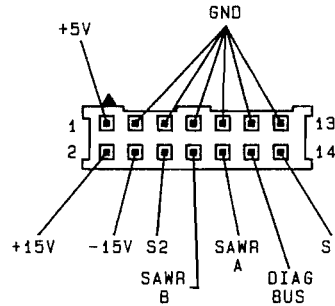

7.    (To enable voltmeter.)
8. Voltage should read approximately +2.5 to +5.5 Vdc.   to repeat measurement.)

**Check Low State**

9.       (To specify low state.)
10.    (To select bit.)
11.    (To enable voltmeter.)
12. Voltage should read approximately -0.5 to +1.5 Vdc.   to repeat measurement.)

**SAWR Select Line B**

**Check High State**

13.       (To specify high state.)
14.    (To select bit.)

---

**A7 MODULE DIAGNOSTICS**

---

15. Connect **VM** probe to test connector line **B** (pin **8**). (See **Figure 3G-1. Cable Plug W2P2 Signal Locator.**)
16.    (To enable voltmeter.)
17. Voltage should read approximately **+2.5** to **+5.5 Vdc.**  
(  to repeat measurement.)

**Check Low State**

18.       (To specify low state.)
19.    (To select bit.)
20.    (To enable voltmeter.)
21. Voltage should read approximately **-0.5** to **+1.5 Vdc.**  
(  to repeat measurement.)
22. Record test results.
23. Return to foldout:
  - Determine next task by comparing test results to conditions shown in each **RESULT BLOCK** for **TEST CONTROL BITS.**

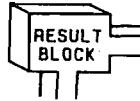

**A7 MODULE DIAGNOSTICS**

---

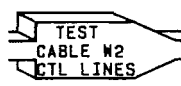
Type:	3; Bit Transmission	<b>A7.11</b>
Run time:	3 min.	
Set-up time:	3 min.	

Internal Voltmeter (VM) is used to measure TTL level changes transmitted to A7 Module on SAWR oscillator select lines A and B.

**Run Test**

1. Switch instrument to **Standby**.
2. Extend **A7 Module** on extender posts, from On-Site Service Kit, and disconnect cable **W2** from **A5 Assembly** at **A5J2**. (Refer to table on foldout in **MECHANICAL PROCEDURES** to locate **A7 Module** extension and **A5** cable disconnection information.)
3. Connect **VM** probe:
  - Connect red alligator clip and pointed tip probe to red test lead provided in On-Site Service Kit.
  - Connect alligator clip to **VM IN (A4TP1)**. (See **A7 MODULE CABLE CONNECTION LOCATOR** on foldout for **VM IN** location.)
4. Turn instrument on.

**SAWR Select Line A**

Check High State

5.        
(To specify high state.)
6.     
(To select bit.)

---

**A7 MODULE DIAGNOSTICS**

---

7. Connect VM probe to solder-side of A5J2 line A (pin 10).  
(See Figure 3G-2. A5J2 Signal Locator.)

**Figure 3G-2. A5J2 Signal Locator**  
(Solder-Side View)

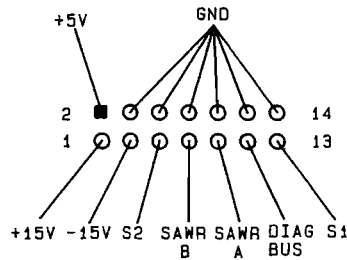

8.     
(To enable voltmeter.)
9. Voltage should read approximately +2.5 to +5.5 Vdc.  
(  to repeat measurement.)

**Check Low State**

10.        
(To specify low state.)
11.     
(To select bit.)
12.     
(To enable voltmeter.)
13. Voltage should read approximately -0.5 to +1.5 Vdc.  
(  to repeat measurement.)

**SAWR Select Line B**

**Check High State**

14.        
(To specify high state.)
15.     
(To select bit.)
-

---

**A7 MODULE DIAGNOSTICS**

---

16. Connect VM probe to solder-side of A5J2 line B (pin 8).  
(See Figure 3G-2. A5J2 Signal Locator.)
17.  2  5  HZ  
(To enable voltmeter.)
18. Voltage should read approximately +2.5 to +5.5 Vdc.  
 5  HZ to repeat measurement.)

**Check Low State**

19.  SHIFT  SPCL  3  6  0  2  
(To specify low state.)
20.  3  1  HZ  
(To select bit.)
21.  2  5  HZ  
(To enable voltmeter.)
22. Voltage should read approximately -0.5 to +1.5 Vdc.  
 5  HZ to repeat measurement.)
23. Record test results.
24. Return to foldout:
  - Determine next task by comparing test results to conditions shown in each CTL LINES.

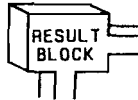

for TEST CABLE W2



---

**A7 MODULE DIAGNOSTICS**

---

<b>Type:</b>	4, Voltage Measurements	<b>A 7.12</b>
<b>Run time:</b>	2 min.	
<b>Set-up time:</b>	2 min.	

Internal Voltmeter (VM) is used to check power supply levels at inputs to A7 Module.

**Run Test**

- Switch instrument to **Standby**:
  - Disconnect **W2** from **A7** at **A7A1 J1**.
  - Plug end of **W2** into **14** pin test connector, from On-Site Service Kit.

**NOTE**

*Find arrowhead on test connector and align with arrowhead on cable plug **W2P2**.*

- Connect **VM** probe:
  - Connect red alligator clip and retractable hook probe to red test lead provided in On-Site Service Kit.
  - Connect alligator clip to **VM IN (A4TP1)**. (See **A7 MODULE CABLE CONNECTION LOCATOR** on fold-out for **VM IN** location.)
- Turn instrument on and enter:
 

SHIFT	SPCL	3	2	5	HZ
-------	------	---	---	---	----

 (To enable Internal Voltmeter.)

**A7 MODULE DIAGNOSTICS**

---

4. Measure voltage levels:
  - Connect VM probe to test connector pin for each power supply line (see Figure 3G-3. Cable Plug W2P2 Signal Locator).
  - **5** **HZ** (To make each voltage measurement.)

**Figure 3G-3. Cable Plug W2P2 Signal Locator**

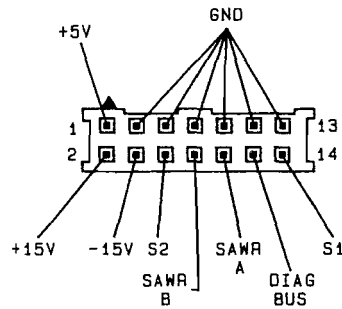

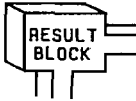
5. Record test results.
6. Return to foldout:
  - Determine next task by comparing test results to conditions shown in each  for TEST Vdc.

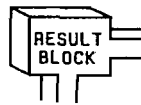

---

**A7 MODULE DIAGNOSTICS**

---

Type:	4, Voltage Measurements	A7.13
Run time:	2 min.	
Set-up time:	3 min.	

Internal Voltmeter (VM) is used to check power supply levels at A5J2.

### Run Test

1. Switch instrument to **Standby**.
2. Extend **A7 Module** on extender posts, from On-Site Service Kit, and disconnect cable **W2** from **A5 Assembly** at **A5J2**. (Refer to table on foldout in **MECHANICAL PROCEDURES** to locate **A7 Module** extension and **A5** cable disconnection information.)
3. Connect **VM** probe:
  - Connect red alligator clip and **pointed tip** probe to red test lead provided in On-Site Service Kit.
  - Connect alligator clip to **VM IN (A4TP1)**. (See **A7 MODULE CABLE CONNECTION LOCATOR** on fold-out for **VM IN** location.)
4. Turn instrument on and enter:  
 SHIFT SPCL 3 2 5 HZ  
 (To enable Internal Voltmeter.)

**A7 MODULE DIAGNOSTICS**

5. Measure voltage levels at **A5J2**:
  - Access signals from solder-side of **A5J2**. (See Figure 3G-4. **A5J2 Signal Locator**.)
  - **5** **HZ** (To make each voltage measurement.)

**Figure 3G-4. A5J2 Signal Locator**  
(Solder-Side View)

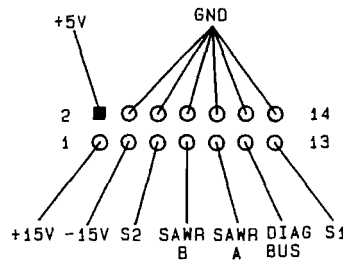

6. Record test results.
7. Return to foldout:
  - Determine next task by comparing test results to conditions shown in each **PS LINES**.

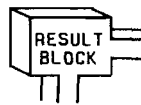

for **TEST CABLE W2**

---

**A7 MODULE DIAGNOSTICS**

---

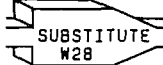
<b>Type:</b>	Cable Substitution	<b>A7.14</b>
<b>Run Time:</b>	5 min.	
<b>Set-up Time:</b>	1 min.	

1. Testing has shown cable **W28** to be suspect, temporarily replace with a test cable from the On-Site Service Kit. Rerun **INSTRUMENT LEVEL DIAGNOSTICS (ILD)** to confirm repair.
2. Refer to **REPLACEABLE PARTS**, in the HP 8642A/B Operating and Service Manual, for information to order a permanent replacement cable.
3. Return to foldout.

---

**A7 MODULE DIAGNOSTICS**

---

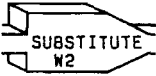
Type:	Cable Substitution	A7.15
Run time:	0 min.	
Set-up time:	3 min.	

Testing has shown cable **W2** to be suspect, temporarily replace with a spare ribbon cable if available. Rerun **INSTRUMENT LEVEL DIAGNOSTICS (ILD)** to confirm repair.

Refer to **REPLACEABLE PARTS**, in the HP 8642A/B Operating and Service Manual, for information to order a permanent replacement cable.

**CAUTION**

*When connecting ribbon cable to A7 Module, find arrowhead on the cable plug and align with arrowhead on the board connector.*

**Reconnect W2**

1. Switch instrument to **Standby** to connect cable **W2** to **A5** Assembly and **A7** Module. (Refer to table on foldout in **MECHANICAL PROCEDURES** for information on connecting cable **W2** to **A5J2**.)
2. Return to foldout.

---

**A7 MODULE DIAGNOSTICS**

---

Type:	Cable Connection	A7.16
Run time:	0 min.	
Set-up time:	3 min.	

**CAUTION**

*When connecting ribbon cable to A7 Module, find arrowhead on the cable plug and align with arrowhead on the board connector.*

**Reconnect W2**

1. Switch instrument to **Standby** to reconnect cable **W2** to **A5 Assembly** or **A7 Module**. (Refer to table on foldout in **MECHANICAL PROCEDURES** for information on reconnecting cable **W2** to **A5J2**.)
2. Return to foldout.

---

**A7 THEORY OF OPERATION**

---

**3G-4. A7 SAWR LOOP MODULE****COMMENT**

*It is not to essential to understand the internal operation of a module to make an on-site repair.*

The **A7 Module** contains a phase locked loop circuit. Oscillator select lines **A** and **B** are decoded to select one of three Surface Acoustic Wave Resonator (SAWR) oscillators. The oscillators are referenced to the **A6 Timebase** output (**45 MHz**).

The **A7 Module** output: **742.5, 787.5, and 832.5 Mhz**, is the UHF reference for the **A11 Reference Loop Module**.

See the **A7 MODULE SIMPLIFIED BLOCK DIAGRAM** for further understanding of the **A7 Module's** internal operation.





---

## A9 IF LOOP MODULE

---

### 3H-1. INTRODUCTION

The **MODULE LEVEL DIAGNOSTICS (MLD)** contained in this section are used to further interrogate the **A9 Module**. The objective is to isolate the failure indicated for this module to the module itself or to a part on which it depends for operation.

#### NOTE

*At this level of testing, recommendations for further action are made on the assumption that the **INSTRUMENT LEVEL DIAGNOSTICS (ILD)** showed no failures for modules **A01-A07**. (For information on using the on-site diagnostics, refer to the **INTRODUCTION** section of this manual.)*

#### CAUTION

*When tightening the coax cable connectors, do not exceed a torque of 1.0 Nm or .74 ft-lbs (slightly tighter than finger tight).*

*When coax cables are disconnected from instrument, do not allow loose ends to come in contact with any exposed circuitry susceptible to short circuiting.*

#### Test Instructions

1. The instrument's **Top Cover** must be removed to run many of these tests. (Refer to the table shown on the foldout in **MECHANICAL PROCEDURES** to locate instructions.)
2. The last page in this group of tests is a foldout and should be pulled out now.
3. Turn to the next page to begin the **A9 MLD**.

---

## A9 MODULE SUBSTITUTION

---

### 3H-2. INTRODUCTION

#### NOTE

*If a known good module is not available, proceed to the next page, A9 INPUTS VERIFICATION.*

The first step in isolating an A9 failure is to substitute in a known good module from the On-Site Service Kit.

#### A9 Substitution Instructions

1. Find **A9 MODULE SUBSTITUTION** on the foldout.
  2. Use the Task Sequence Diagram, shown under **A9 MODULE SUBSTITUTION**, to direct you through the substitution process. Each Task Arrow shown in the diagram indicates a task title and task number. The tasks are numbered according to the order in which they are arranged in this section. Turn to the task indicated and complete the procedure.
  3. After completing the procedure, return to the Task Sequence Diagram on the foldout and determine the next task to be performed.
  4. Begin now by performing the first task shown on the diagram.
-

---

## A9 INPUTS VERIFICATION

---

### 3H-3. INTRODUCTION



If a known good **A9 Module** is not available, or if you were not able to isolate the failure using the **A9 MODULE SUBSTITUTION** procedure, the Task Sequence Diagrams, shown under **A9 INPUTS VERIFICATION**, should be used to check each signal path into the A9 Module.

#### A9 Inputs Verification Instructions

1. Find **A9 INPUTS VERIFICATION** on the foldout.
2. The Task Sequence Diagrams, shown under **A9 INPUTS VERIFICATION**, are separated into three checks: **RF**, **Control** and **Power Supply** signals.
3. Use the Task Sequence Diagrams to direct you through the verification process. Each Task Arrow shown in a diagram indicates a task title and task number. The tasks are numbered according to the order in which they are arranged in this section. Turn to the page indicated and complete the procedure.
4. After completing the procedure, return to the Task Sequence Diagram on the foldout and determine the next task to be performed.
5. Begin now by performing the first task shown under 1. **A9 RF INPUT CHECK**.

#### NOTE

*The **A9 MODULE I/O SIGNALS DIAGRAM** shows all parts which the A9 Module depends on for operation.*

**A9 MODULE DIAGNOSTICS**

---

Type:	1; Loop Lock/Unlock	A9.02
Run time:	2 min. 40 sec.	
Set-up time:	0	

**Run Test**

1. **INSTR PRESET** **SHIFT**  
 (Hold shift key until "100.000000MZ -140.0DM" appears, to override 20 second reset test.)
2. **SHIFT** **SPCL** **3** **3** **3** **5** **HZ**.
3. When "DIAG DONE HIT MSSG .V1" appears:
  - Use **MSSG** to scroll through messages.
  - Record error code(s) displayed for A9.

**COMMENT**

*If any error codes are displayed for modules A01-A07, you need to isolate those failure(s) before performing the A9 MODULE SUBSTITUTION. (Refer to INSTRUMENT LEVEL DIAGNOSTICS to determine correct order for troubleshooting modules.)*

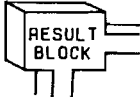
4. Return to foldout:
  - Determine next task by comparing test results to conditions shown in each  for TEST A9 MODULE.

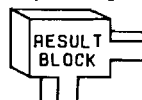

---

### A9 MODULE DIAGNOSTICS

---

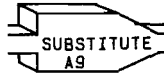
<b>Type:</b>	Module Substitution	<b>A9.03</b>
<b>Run time:</b>	0	
<b>Set-up time:</b>	5 min.	

The following describes the technique for connecting a known good A9 Module without removing the A9 Module in the instrument.

#### Connect Substitute Module

1. Switch instrument to Standby.
2. Disconnect cables **W3**, **W26** and **W30** from **A9 Module** (see **A9 MODULE CABLE CONNECTION LOCATOR** on foldout).
3. Without removing **A9 Module** from instrument, carefully lay substitute **A9 Module** on top of modules **A11**, **A12** and **A13**.

CAUTION

*When connecting ribbon cable, find arrowhead on cable connector and align with arrowhead on board connector.*

4. Connect cables **W3**, **W26** and **W30** to substitute module.
5. Turn instrument on.
6. Return to foldout.

---

**A9 MODULE DIAGNOSTICS**

---

Type:	Substitute Module Test	A9.04
Run time:	1 min.	
Set-up time:	0	

Test operation of substitute A9 Module by repeating test performed on A9 Module before substitution.

**Run Test**

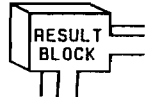
1. **INSTR PRESET** **SHIFT**  
 (Hold shift key until "100.000000MZ -140.0DM" appears, to override 20 second reset test.)
2. **SHIFT** **SPCL** **3** **3** **3** **5** **HZ**.
3. When "DIAG DONE HIT MSSG .Vi" appears:
  - Use **MSSG** to scroll through messages.
  - Record error code(s) displayed for A9.
4. Return to foldout:
  - Determine next task by comparing test results to conditions shown in each  for TEST SUB A9.

**A9 MODULE DIAGNOSTICS**

---

Type:	Additional A9 Tests	A9.05
Run time:	Conditional	
Set-up time:	Conditional	

The A9 failure conditions for arriving at this task are described below. Follow the procedure for the condition which fits your module.

- Condition 1: Instrument Level Self Test indicated A9 failure.
- Condition 2: A12 Module RF Power Test indicated A9 failure.
- Condition 3: Instrument must be set to a specific operating condition to detect A9 failure.

**Condition 1**

1. **INSTR PRESET** **SHIFT**  
 (Hold shift key until "100.000000MZ -140.0DM" appears, to override 20 second reset test.
2. **SHIFT** **SPCL** **3** **3** **0** **HZ**.
3. When "WAITING FOR SETUP 1.V24" appears:
  - Connect BNC Tee connector, from On-Site Service Kit, to "FM/ΦM INPUT" (see INSTRUMENT LEVEL DIAGNOSTICS foldout for set-up diagram).
  - Connect a coax cable from Tee connector to "MOD OUTPUT".
  - Connect a coax cable from Tee to "AM/PULSE INPUT"
4. When "DIAG DONE HIT MSSGS.VI" appears:
  - Use **MSSG** to scroll through messages.
  - Record A9 error codes.

**COMMENT**

*If any error codes are displayed for modules A01-A07, you need to isolate those failure(s) before performing the A9 MODULE SUBSTITUTION. (Refer to INSTRUMENT LEVEL DIAGNOSTICS to determine correct order for troubleshooting modules.)*

5. Return to foldout.
-



---

**A9 MODULE DIAGNOSTICS**

---

**Condition 2**

1. **[INSTR PRESET] [SHIFT]**  
(Hold shift key until "100.000000MZ -140.0DM" appears, to override 20 second reset test.)
2. **[SHIFT] [SPCL] [3] [3] [3] [7] [HZ]**
3. When "WAITING FOR SET-UP 1 .V24" appears:
  - Disconnect cable **W26** from module at **A9A2 J3**.
  - Connect **YELLOW PM** cable and adapter to cable **W26**.
  - **[HZ]** to continue test.
4. When "WAITING FOR SET-UP 2 .V25" appears:
  - Reconnect cable **W26** to module at **A9A2 J3**.
  - Disconnect cable **W30** from module at **A9A1 J4**.
  - Connect **PM** cable to module at **A9A1 J4**.
  - **[HZ]** to continue test.
5. When "RECONNECT ALL CABLES .V29" appears:
  - Reconnect cable **W30** to module at **A9A1 J4**.
  - **[HZ]** to continue test.
6. When "DIAG DONE HIT MSSGS .V1" appears:
  - Use **[MSSG]** to scroll through messages.
  - Record error code(s) displayed for **A9**.
7. Return to foldout.

**Condition 3**

1. Set instrument to operating condition which causes **A9 failure**.
  2. Record instrument set-up and error message(s).
  3. Return to foldout.
-

**A9 MODULE DIAGNOSTICS**

Type:	Additional Substitute	<b>A9.06</b>
Run time:	A9 Tests	
Set-up time:	Conditional	

Test operation of substitute A9 Module by repeating test(s) performed on A9 Module before substitution.

- Condition 1: Instrument Level Self Test indicated A9 failure.
- Condition 2: A12 Module RF Power Test indicated A9 failure.
- Condition 3: Instrument must be set to a specific operating condition to detect A9 failure.

Condition 1

1. **[INSTR PRESET] [SHIFT]**  
(Hold shift key until "100.000000MZ -140.0DM" appears, to override 20 second reset test.
2. **[SHIFT] [SPCL] [3] [3] [0] [HZ]**.
3. When "WAITING FOR SETUP 1 .V24" appears:
  - Connect BNC Tee connector, from On-Site Service Kit, to "FM/ΦM INPUT" (see INSTRUMENT LEVEL DIAGNOSTICS foldout for set-up diagram).
  - Connect a coax cable from Tee connector to "MOD OUTPUT".
  - Connect a coax cable from Tee to "AM/PULSE INPUT"
4. When "DIAG DONE HIT MSSGS.VI" appears:
  - Use **[MSSG]** to scroll through messages.
  - Record A9 error codes.

**COMMENT**

*If any error codes are displayed for modules A01-A07, you need to isolate those failure(s) now.*

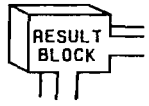
5. Return to foldout.
  - Determine next task by comparing test results to conditions shown in each  for TEST SUB A9 FURTHER.

**A9 MODULE DIAGNOSTICS**

---

**Condition 2**

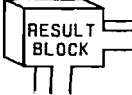
1. **[INSTR PRESET] [SHIFT]**  
 (Hold shift key until "100.000000MZ -140.0DM" appears, to override 20 second reset test.)
2. **[SHIFT] [SPCL] [3] [3] [3] [7] [HZ]**
3. When "WAITING FOR SET-UP 1 .V24" appears:
  - Disconnect cable W26 from module at A9A2 J3.
  - Connect **YELLOW PM** cable and adapter to cable W26.
  - **[HZ]** to continue test.
4. When "WAITING FOR SET-UP 2 .V25" appears:
  - Reconnect cable W26 to module at A9A2 J3.
  - Disconnect cable W30 from module at A9A1 J4.
  - Connect **PM** cable to module at A9A1 J4.
  - **[HZ]** to continue test.
5. When "RECONNECT ALL CABLES .V29" appears:
  - Reconnect cable W30 to module at A9A1 J4.
  - **[HZ]** to continue test.
6. When "DIAG DONE HIT MSSGS .V1" appears:
  - Use **[MSSG]** to scroll through messages.
  - Record error code(s) displayed for A9.
7. Return to foldout:
  - Determine next task by comparing test results to conditions shown in each  for TEST SUB A9 FURTHER.

**Condition 3**

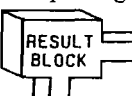
1. Set instrument to operating condition which causes A9 failure.
2. Record instrument set-up and error message(s).
3. Return to foldout:
  - Determine next task by comparing test results to conditions shown in each  for TEST SUB A9 FURTHER.

---

**A9 MODULE DIAGNOSTICS**

---

Type:	Cable Connection	A9.07
Run time:	0	
Set-up time:	5 min.	

**Connect Module**

1. Switch instrument to **Standby**.
2. Disconnect cables **W3**, **W26** and **W30** from substitute **A9 Module**.

**CAUTION**

*When connecting ribbon cable, find arrowhead on cable connector and align with arrowhead on board connector.*

3. Reconnect cables **W3**, **W26** and **W30** to **A9 Module**.
4. Turn instrument on.
5. Return substitute **A9 Module** to On-Site Service Kit.
6. Return to foldout.

**A9 MODULE DIAGNOSTICS**

Type:	2A; RF Power Levels	<b>A9.08</b>
Run time:	2 min. 30 sec.	
Set-up time:	3 min.	

RF signal level is measured using Internal Power Meter (PM).



*Do not permit end of Internal Power Meter cable to short circuit instrument by coming in contact with any exposed circuitry.*

**Run Test**

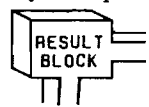
1. **INSTR PRESET** **SHIFT**  
 (Hold shift key until "100.000000MZ -140.0DM" appears, to override 20 second reset test.)
2. **SHIFT** **SPCL** **3** **6** **8** **1** **2** **HZ**  
 (To check input levels only.)
3. **3** **3** **7** **HZ**.
4. When "WAITING FOR SET-UP 1 .V24" appears:
  - Disconnect cable W26 from module at A9A2 J3.
  - Connect **YELLOW PM** cable and adapter to cable W26.
  - **HZ** to continue test.
5. When "RECONNECT ALL CABLES .V29" appears:
  - Reconnect cable W26 to module at A9A2 J3.
  - **HZ** to continue test.
6. When "DIAG DONE HIT MSSGS .V1" appears:
  - Use **MSSG** to scroll through messages.
  - Record error code(s) displayed for A9.
7. Return to foldout:
  - Determine next task by comparing test results to conditions shown in each  for **TEST RF POWER**.

---

**A9 MODULE DIAGNOSTICS**

---

Type:	2A; RF Power Levels	<b>A9.09</b>
Run time:	2 min. 30 sec.	
Set-up time:	3 min.	

RF signal level is measured using Internal Power Meter (PM).

**Run Test**

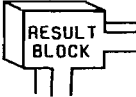
1.    
 Hold shift key until  
 "100.000000MZ -140.0DM" appears,  
 to override 20 second reset test.)
2.          
 (To check input levels only.)
3.
4. When "WAITING FOR SET-UP 1 .V24" appears:
  - Disconnect cable W26 from A6 Module at A6A2 J6.  
 (See Top View Diagram inside Top Cover to locate W26 connection on A6 Module.)
  - Connect YELLOW PM cable to module at A6A2 J6.
  - to continue test.
5. When "RECONNECT ALL CABLES .V29" appears:
  - Reconnect cable W26 to module at A6A2 J6.
  - to continue test.
6. When "DIAG DONE HIT MSSGS.V1" appears:
  - Use  to scroll through messages.
  - Record error code(s) displayed for A9.
7. Return to foldout:
  - Determine next task by comparing test results to conditions shown in each  for TEST CABLE W26.

---

**A9 MODULE DIAGNOSTICS**

---

Type:	3; Bit Transmission
Run time:	0 min.
Set-up time:	5 min.

**A9.10**

Internal Voltmeter (VM) is used to measure TTL level changes transmitted to A9 Module Data and Clock lines.

**COMMENT**

*If any control line level measures bad, it is not necessary to test remaining lines; proceed directly to step 23.*

**Run Test**

1. Switch instrument to Standby:
  - Disconnect cable W3 from module at A9A2 J1.
  - Plug end of W3 into 26 pin test connector, from On-Site Service Kit.

**NOTE**

*Find arrowhead on test connector and align with arrowhead on cable plug W3P2.*

**CAUTION**

*To prevent damage to the Power Supply and Control sections, do not permit the exposed pins on the test connector to short circuit.*

2. Connect VM probe:
    - Connect red alligator clip and retractable hook probe to red test lead provided in On-Site Service Kit.
    - Connect alligator clip to VM IN (A4TP1). (See A9 MODULE CABLE CONNECTION LOCATOR on fold-out for VM IN location.)
  3. Turn instrument on.
-

**A9 MODULE DIAGNOSTICS**

**Data and Clock Control Lines**

**Check High State**

4.        
 (To specify high state.)

**NOTE**

*A "0" will appear in display indicating that these data bits will be set low. However, the bits are inverted in the Control Section before they are sent to A9.*

5. Enter **Bit Select Keys**, as indicated in Table 3H-1. **W3P2 Control Bits**, for Control Line to be tested.
6. Connect VM probe to Control Line at Pin Number indicated in Table 3H-1. (See Figure 3H-1. Cable Plug W3P2 Signal Locator.)

**Table 3H-1. W3P2 Control Bits**

Test Order	Control Line	Bit Select Keys (Steps 5 and 10)	Pin Number (Step 6)
1	C0	<input type="text" value="3"/> <input type="text" value="2"/> <input type="text" value="HZ"/>	18
2	C1	<input type="text" value="3"/> <input type="text" value="3"/> <input type="text" value="HZ"/>	19
3	C2	<input type="text" value="3"/> <input type="text" value="4"/> <input type="text" value="HZ"/>	21
4	C3	<input type="text" value="3"/> <input type="text" value="5"/> <input type="text" value="HZ"/>	22
5	H INV	<input type="text" value="3"/> <input type="text" value="6"/> <input type="text" value="HZ"/>	16
6	H EXT CLK	<input type="text" value="3"/> <input type="text" value="7"/> <input type="text" value="HZ"/>	14



**A9 MODULE DIAGNOSTICS**

**Figure 3H-1. Cable Plug W3P2 Signal Locator**

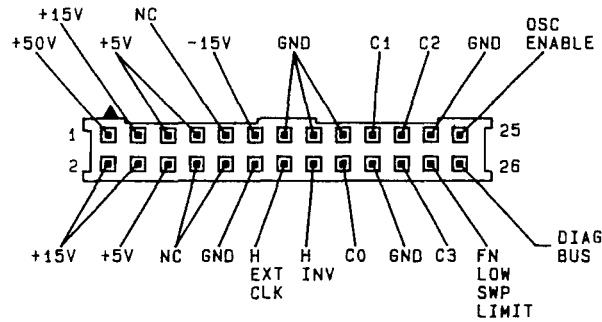

7.    (To enable voltmeter.)
8. Voltage should read approximately +2.5 to +5.5 Vdc. (  to repeat measurement.)

**Check Low State**

9.       (To specify low state.)

**NOTE**

*A "1" will appear in display indicating that these data bits will be set high. However, the bits are inverted in the Control Section before they are sent to A9.*

10. Enter **Bit Select Keys**, as indicated in **Table 3H-1. W3P2 Control Bits**, for same **Control Line**.
11.    (To enable voltmeter.)
12. Voltage should read approximately -0.5 to +1.5 Vdc. (  to repeat measurement.)
13. Repeat procedure for each **Control Line** shown in **Table 3H-1**.

---

**A9 MODULE DIAGNOSTICS**



---

**Oscillator Enable****Check High State**

14. **SHIFT** **SPCL** **3** **6** **0** **1**  
(To specify high state.)
15. **3** **8** **HZ**  
(To select bit.)
16. Connect **VM** probe to test connector line **OSC ENABLE** (pin 25).
17. **2** **5** **HZ**  
(To enable voltmeter.)
18. Voltage should read approximately **+2.5 to +5.5 Vdc**.  
(**5** **HZ**) to repeat measurement.)

**Check Low State**

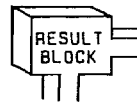
19. **SHIFT** **SPCL** **3** **6** **0** **2**  
(To specify low state.)
20. **3** **8** **HZ**  
(To select bit.)
21. **2** **5** **HZ**  
(To enable voltmeter.)
22. Voltage should read approximately **-0.5 to +1.5 Vdc**.  
(**5** **HZ**) to repeat measurement.)
23. Record test results.
24. Return to foldout:
  - Determine next task by comparing test results to conditions shown in each **RESULT BLOCK** for **TEST CONTROL BITS**.



**A9 MODULE DIAGNOSTICS**

---

Type:	3; Bit Transmission	<b>A9.11</b>
Run time:	3 min.	
Set-up time:	3 min.	

Internal Voltmeter (VM) is used to measure TTL level changes transmitted to **A9 Module** Clock and Data lines.

**Run Test**

1. Switch instrument to **Standby**.
2. Extend **A9 Module** on extender posts, from On-Site Service Kit, and disconnect cable **W3** from **A5 Assembly** at **A5J3**. (Refer to table on foldout in **MECHANICAL PROCEDURES** to locate **A9 Module** extension and **A5** cable disconnection information.)
3. Connect **VM** probe:
  - Connect red alligator clip and pointed tip probe to red test lead provided in On-Site Service Kit.
  - Connect alligator clip to **VM IN (A4TP1)**. (See **A9 MODULE CABLE CONNECTION LOCATOR** on foldout for **VM IN** location.)
4. Turn instrument on.

**NOTE**

*It is only necessary to perform this test on failing control line.*

**Data and Clock Control Lines**

**Check High State**

5.  SHIFT  SPCL  3  6  0  2  
 (To specify high state.)

**NOTE**

*A "0" will appear in display indicating that these data bits will be set low. However, the bits are inverted in the Control Section before they are sent to A9.*

6. Enter Bit Select Keys, as indicated in **Table 3H-2. A5J3 Control Bits**, for Control Line to be tested.
-

**A9 MODULE DIAGNOSTICS**

7. Connect VM probe to Control Line at Pin Number indicated in Table 3H-2. (See Figure 3H-2. Cable Plug A5J3 Signal Locator.)

Table 3H-2. A5J3 Control Bits

Test Order	Control Line	Bit Select Keys (Steps 6 and 11)	Pin Number (Step 7)
1	C0	[3] [2] [HZ]	18
2	C1	[3] [3] [HZ]	19
3	C2	[3] [4] [HZ]	21
4	C3	[3] [5] [HZ]	22
5	H INV	[3] [6] [HZ]	16
6	H EXT CLK	[3] [7] [HZ]	14

Figure 3H-2. Cable Plug A5J3 Signal Locator

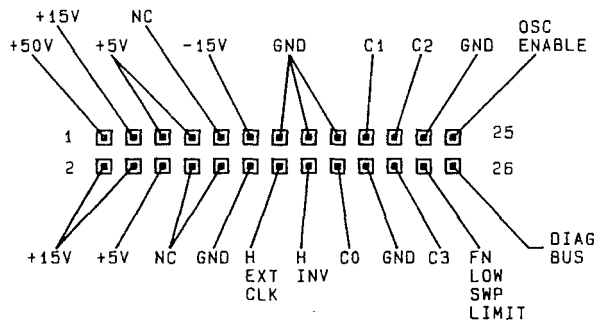

8. [2] [5] [HZ]  
(To enable voltmeter.)
9. Voltage should read approximately +2.5 to +5.5 Vdc.  
[5] [HZ] to repeat measurement.)

**Check Low State**

10. [SHIFT] [SPCL] [3] [6] [0] [1]  
(To specify low state.)

---

**A9 MODULE DIAGNOSTICS**

---

**NOTE**

A "1" will appear in display indicating that these data bits will be set high. However, the bits are inverted in the Control Section before they are sent to A9.

11. Enter **Bit Select Keys**, as indicated in Table 3H-2. **W3P2 Control Bits**, for same **Control Line**.
12.     
(To enable voltmeter.)
13. Voltage should read approximately **-0.5 to +1.5 Vdc**.  
(  to repeat measurement.)

**Oscillator Enable****Check High State**

14.        
(To specify high state.)
15.     
(To select bit.)
16. Connect **VM** probe to test connector line **OSC ENABLE** (pin 25).
17.     
(To enable voltmeter.)
18. Voltage should read approximately **+2.5 to +5.5 Vdc**.  
(  to repeat measurement.)

**Check Low State**

19.        
(To specify low state.)
20.     
(To select bit.)
21.     
(To enable voltmeter.)
22. Voltage should read approximately **-0.5 to +1.5 Vdc**.  
(  to repeat measurement.)
23. Record test results.
24. Return to foldout:
  - Determine next task by comparing test results to conditions shown in each **CTL LINES**.

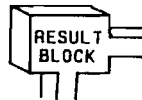

---

**A9 MODULE DIAGNOSTICS**

---

<b>Type:</b>	4, Voltage Measurements	<b>A9.12</b>
<b>Run time:</b>	2 min.	
<b>Set-up time:</b>	2 min.	

Internal Voltmeter (VM) is used to check power supply levels at inputs to A9 Module.

**Run Test**

- Switch instrument to Standby:
  - Disconnect **W3** from **A9** at **A9A2 J1**.
  - Plug end of **W3** into 26 pin test connector, from On-Site Service Kit.

**NOTE**

*Find arrowhead on test connector and align with arrowhead on cable plug **W3P2**.*

- Connect VM probe:
  - Connect red alligator clip and retractable hook probe to red test lead provided in On-Site Service Kit.
  - Connect alligator clip to **VM IN (A4TP1)**. (See **A9 MODULE CABLE CONNECTION LOCATOR** on fold-out for **VM IN** location.)
- Turn instrument on and enter:  
       
 (To enable Internal Voltmeter.)

**A9 MODULE DIAGNOSTICS**

4. Measure voltage levels:
  - Connect VM probe to test connector pin for each power supply line (see Figure 3H-3. Cable Plug W3P2 Signal Locator).
  - 5 HZ (To make each voltage measurement.)

**Figure 3H-3. Cable Plug W3P2 Signal Locator**

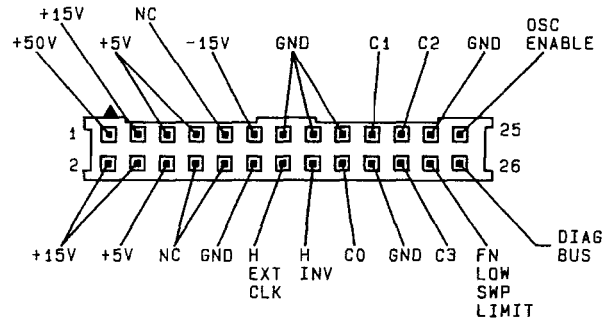

5. Record test results.
6. Return to foldout:
  - Determine next task by comparing test results to conditions shown in each

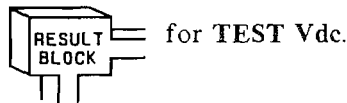

---

**A9 MODULE DIAGNOSTICS**

---

<b>Type:</b>	4, Voltage Measurements	<b>A9.13</b>
<b>Run time:</b>	2 min.	
<b>Set-up time:</b>	3 min.	

Internal Voltmeter (VM) is used to check power supply levels at A5J3.

**Run Test**

1. Switch instrument to **Standby**.
2. Extend **A9 Module** on extender posts, from On-Site Service Kit, and disconnect cable **W3** from **A5 Assembly** at **A5J3**. (Refer to table on foldout in **MECHANICAL PROCEDURES** to locate **A9 Module** extension and **A5 cable** disconnection information.)
3. Connect **VM** probe:
  - Connect red alligator clip and pointed tip probe to red test lead provided in On-Site Service Kit.
  - Connect alligator clip to **VM IN (A4TP1)**. (See **A9 MODULE CABLE CONNECTION LOCATOR** on fold-out for **VM IN** location.)
4. Turn instrument on and enter:  
 (SHIFT) (SPCL) (3) (2) (5) (HZ)  
 (To enable Internal Voltmeter.)



**A9 MODULE DIAGNOSTICS**

5. Measure voltage levels at **A5J3**:
  - Access signals from solder-side of **A5J3**. (See Figure 3H-4, **A5J3 Signal Locator**.)
  - **5** **HZ** (To make each voltage measurement.)

**Figure 3H-4. A5J3 Signal Locator**  
(Solder-Side View)

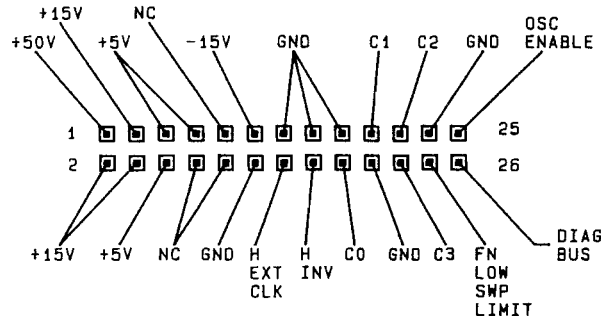

6. Record test results.
7. Return to folout:
  - Determine next task by comparing test results to conditions shown in each **PS LINES**.

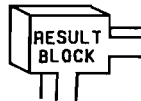

for **TEST CABLE W3**

---

**A9 MODULE DIAGNOSTICS**

---

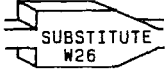
Type:	Cable Substitution	A9.14
Run Time:	5 min.	
Set-up Time:	1 min.	

1. Testing has shown cable **W26** to be suspect, temporarily replace with a test cable from the On-Site Service Kit. Rerun **INSTRUMENT LEVEL DIAGNOSTICS (ILD)** to confirm repair.
2. Refer to **REPLACEABLE PARTS**, in the HP 8642A/B Operating and Service Manual, for information to order a permanent replacement cable.
3. Return to foldout.

---

**A9 MODULE DIAGNOSTICS**

---

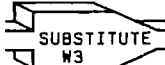
Type:	Cable Substitution	A9.15
Run time:	0 min.	
Set-up time:	3 min.	

Testing has shown cable **W3** to be suspect, temporarily replace with a spare ribbon cable if available. Rerun **INSTRUMENT LEVEL DIAGNOSTICS (ILD)** to confirm repair.

Refer to **REPLACEABLE PARTS**, in the HP 8642A/B Operating and Service Manual, for information to order a permanent replacement cable.

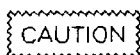

*When connecting ribbon cable to A9 Module, find arrowhead on the cable plug and align with arrowhead on the board connector.*

**Reconnect W3**

1. Switch instrument to **Standby** to connect cable **W3** to **A5** Assembly and **A9** Module. (Refer to **MECHANICAL PROCEDURES** for information on connecting cable **W3** to **A5J3**.)
  2. Return to foldout.
-

---

**A9 MODULE DIAGNOSTICS**

---

Type:	Cable Connection	A9.16
Run time:	0 min.	
Set-up time:	3 min.	

**CAUTION**

*When connecting ribbon cable to A9 Module, find arrowhead on the cable plug and align with arrowhead on the board connector.*

**Reconnect W3**

1. Switch instrument to **Standby** to reconnect cable **W3** to **A5** Assembly or **A9** Module. (Refer to **MECHANICAL PROCEDURES** for information on reconnecting cable **W3** to **A5J3**.)
2. Return to foldout.

---

**A9 THEORY OF OPERATION**

---

**3H-4. A9 IF LOOP MODULE****COMMENT**

*It is not to essential to understand the internal operation of a module to make an on-site repair.*

The **A9 Module** contains a phase locked loop which is referenced to the **A6 Module** timebase output (**500 kHz**). A fractional-N divider in the loop's feedback path and compensating circuitry in the oscillator tune path allow frequency steps of **.05 Hz** at the output.

The fractional-N control signals are decoded to select one of six voltage controlled oscillators to produce the output frequency range of **45 to 90 MHz**. The **A9 Module** output provides the reference signal for the **A12 Module**.

See the **A9 MODULE SIMPLIFIED BLOCK DIAGRAM** for further understanding of the **A9 Module's** internal operation.

---

**A11 REFERENCE LOOP MODULE**

---

**3I-1. INTRODUCTION**

The **MODULE LEVEL DIAGNOSTICS (MLD)** contained in this section are used to further interrogate the **A11 Module**. The objective is to isolate the failure indicated for this module to the module itself or to a part on which it depends for operation.

**NOTE**

*At this level of testing, recommendations for further action are made on the assumption that the **INSTRUMENT LEVEL DIAGNOSTICS (ILD)** showed no failures for modules **A01-A09**. (For information on using the on-site diagnostics, refer to the **INTRODUCTION** section of this manual.)*

**CAUTION**

*When tightening the coax cable connectors, do not exceed a torque of 1.0 Nm or .74 ft-lbs (slightly tighter than finger tight).*

*When coax cables are disconnected from instrument, do not allow loose ends to come in contact with any exposed circuitry susceptible to short circuiting.*

**Test Instructions**

1. The instrument's **Top Cover** must be removed to run many of these tests. (Refer to the table shown on the foldout in **MECHANICAL PROCEDURES** to locate instructions.)
2. The last page in this group of tests is a foldout and should be pulled out now.
3. Turn to the next page to begin the **A11 MLD**.

---

## A11 INPUTS VERIFICATION

---

### 3I-2. INTRODUCTION

The first step in isolating a failure in the **A11 Module** is to verify correct operation of each input signal. Use the **A11 INPUTS VERIFICATION** procedure to check each signal path into the A11 Module.

#### A11 Inputs Verification Instructions

1. Find **A11 INPUTS VERIFICATION** on the foldout.
2. The Task Sequence Diagrams, shown under **A11 INPUTS VERIFICATION**, are separated into three checks: **RF**, **Control** and **Power Supply** signals.
3. Use the Task Sequence Diagrams to direct you through the verification process. Each Task Arrow shown in a diagram indicates a task title and task number. The tasks are numbered according to the order they are arranged in this section. Turn to the task indicated and complete the procedure.
4. After completing the procedure, return to the Task Sequence Diagram on the foldout and determine the next task to be performed.
5. Begin now by performing the first task shown under **1. A11 RF INPUT CHECK**.

#### NOTE

*The A11 MODULE I/O SIGNALS DIAGRAM shows all parts which the A11 Module depends on for operation.*

---

**A11 MODULE SUBSTITUTION**

---

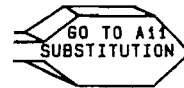
**A11.01****3I-3. INTRODUCTION**

If you were unable to isolate the failure using the **A11 INPUTS VERIFICATION** procedure, then follow the Task Sequence Diagram, shown under **A11 MODULE SUBSTITUTION**, to substitute in a known good module from the On-site Service Kit.

**A11 Substitution Instructions**

1. Find **A11 MODULE SUBSTITUTION** on the foldout.
2. Use the Task Sequence Diagram, shown under **A11 MODULE SUBSTITUTION**, to direct you through the substitution process. Each Task Arrow shown in the diagram indicates a task title and task number. The tasks are numbered according to the order in which they are arranged in this section. Turn to the task indicated and complete the procedure.
3. After completing the procedure, return to the Task Sequence Diagram on the foldout and determine the next task to be performed.
4. Begin now by performing the first task shown on the diagram.



---

**A11 MODULE DIAGNOSTICS**

---

Type:	2A; RF Power Levels	<b>A11.02</b>
Run time:	20 sec.	
Set-up time:	3 min.	

RF signal level is measured using Internal Power Meter (PM).

CAUTION

*Do not permit end of Internal Power Meter cable to short circuit instrument by coming in contact with any exposed circuitry.*

**Run Test**

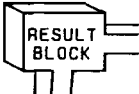
1. **INSTR PRESET** **SHIFT**  
(Hold shift key until "100.000000MZ -140.0DM" appears, to override 20 second reset test.)
2. **SHIFT** **SPCL** **3** **6** **8** **1** **3** **HZ**  
(To check input levels only.)
3. **3** **3** **1** **HZ**.
4. When "WAITING FOR SET-UP 1 .V24" appears:
  - Disconnect cable **W25** from module at **A11A3 J4**.
  - Connect **YELLOW PM** cable and adapter to cable **W25**.
  - **HZ** to continue test.
5. When "WAITING FOR SET-UP 2 .V25" appears:
  - Reconnect cable **W25** to module at **A11A3 J4**.
  - Disconnect cable **W24** from module at **A11A1 J3**.
  - Connect **YELLOW PM** cable and adapter to cable **W24**.
  - **HZ** to continue test.
6. When "RECONNECT ALL CABLES .V29" appears:
  - Reconnect cable **W24** to module at **A11A1 J3**.
  - **HZ** to continue test.
7. When "DIAG DONE HIT MSSGS .V1" appears:
  - Use **MSSG** to scroll through messages.
8. Return to foldout:
  - Determine next task by comparing test results to conditions shown in each  for **TEST RF POWER**.

**A11 MODULE DIAGNOSTICS**

Type:	2A; RF Power Levels	<b>A11.03</b>
Run time:	10 sec.	
Set-up time:	2 min.	

RF signal level is measured using Internal Power Meter (PM).

**Run Test**

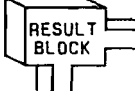
1. **[INSTR PRESET] [SHIFT]**  
 Hold shift key until "100.00000MZ -140.0DM" appears, to override 20 second reset test.)
2. **[SHIFT] [SPCL] [3] [6] [8] [1] [2] [HZ]**  
 (To check input levels only.)
3. **[3] [3] [1] [HZ]**
4. When "WAITING FOR SET-UP 1 .V24" appears:
  - Disconnect cable W25 from A7 Module at A7A1 J3. (See Top View Diagram inside Top Cover to locate W25 connection on A7 Module.)
  - Connect **YELLOW PM** cable to module at A7A1 J3.
  - **[HZ]** to continue test.
5. When "RECONNECT ALL CABLES .V29" appears:
  - Reconnect cable W25 to module at A7A1 J3.
  - **[HZ]** to continue test.
6. When "DIAG DONE HIT MSSGS .V1" appears:
  - Use **[MSSG]** to scroll through messages.
7. Return to foldout:
  - Determine next task by comparing test results to conditions shown in each  for **TEST CABLE W25**.

---

**A11 MODULE DIAGNOSTICS**

---

Type:	2A; RF Power Levels	A11.04
Run time:	15 sec.	
Set-up time:	2 min.	

RF signal level is measured using Internal Power Meter (PM).

**Run Test**

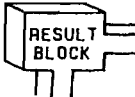
1. **INSTR PRESET** **SHIFT**  
Hold shift key until "100.000000MZ -140.0DM" appears, to override 20 second reset test.)
2. **SHIFT** **SPCL** **3** **6** **8** **1** **3** **HZ**  
(To check input levels only.)
3. **3** **3** **1** **HZ**
4. When "WAITING FOR SET-UP 1 .V24" appears:
  - Disconnect cable W25 from module at A7A1 J3. (See Top View Diagram inside Top Cover to locate W25 connection on A7 Module.)
  - Connect **YELLOW PM** cable to module at A7A1 J3.
  - **HZ** to continue test.
5. When "WAITING FOR SET-UP 2 .V25" appears:
  - Reconnect cable W25 to module at A7A1 J3.
  - Disconnect cable W24 from module at A6A1 J2.
  - Connect **YELLOW PM** cable to module at A6A1 J2.
  - **HZ** to continue test.
6. When "RECONNECT ALL CABLES .V29" appears:
  - Reconnect cable W24 to module at A6A1 J2.
  - **HZ** to continue test.
7. When "DIAG DONE HIT MSSGS .V1" appears:
  - Use **MSSG** to scroll through messages.
8. Return to foldout:
  - Determine next task by comparing test results to conditions shown in each  for **TEST CABLE W24**.

---

**A11 MODULE DIAGNOSTICS**

---

Type:	3; Bit Transmission	A11.05
Run time:	3 min.	
Set-up time:	2 min.	

Internal Voltmeter (VM) is used to measure TTL level changes transmitted to **A11 Module** on Clock and Data control lines.

**Run Test**

- Switch instrument to **Standby**:
  - Disconnect cable **W4** from module at **A11A1 J1**.
  - Plug end of **W4** into **16 pin** test connector, from On-Site Service Kit.

**NOTE**

*Find arrowhead on test connector and align with arrowhead on cable plug **W4P2**.*

**CAUTION**

*To prevent damage to the Power Supply and Control sections, do not permit the exposed pins on the test connector to short circuit.*

- Connect VM probe:
  - Connect red alligator clip and retractable hook probe to red test lead provided in On-Site Service Kit.
  - Connect alligator clip to **VM IN (A4TP1)**. (See **A11 MODULE CABLE CONNECTION LOCATOR** on fold-out for **VM IN** location.)
- Turn instrument on.

**Clock Line****Check High State**

- (To specify high state.)

**NOTE**

*A "0" will appear in display indicating that the data bit will be set low. However, the bit is inverted in the Control Section before it is sent to A11.*

---

---

**A11 MODULE DIAGNOSTICS**

---

5.     
(To select bit.)
6. Connect VM probe to test connector line REF CLK (pin 12). (See Figure 3I-1. Cable Plug W4P2 Signal Locator.)

Figure 3I-1. Cable Plug W4P2 Signal Locator

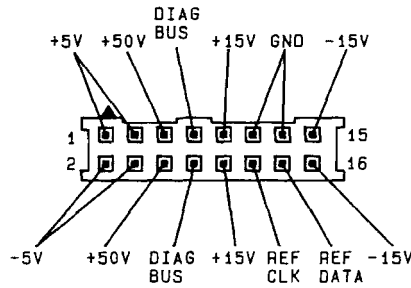

7.     
(To enable voltmeter.)
8. Voltage should read approximately +2.5 to +5.5 Vdc.  
  to repeat measurement.)

**Check Low State**

9.        
(To specify low state.)

**NOTE**

*A "1" will be appear in display indicating that the data bit will be set high. However, the bit is inverted in the Control Section before it is sent to A11.*

10.     
(To select bit.)
  11.     
(To enable voltmeter.)
  12. Voltage should read approximately -0.5 to +1.5 Vdc.  
  to repeat measurement.)
-

---

**A11 MODULE DIAGNOSTICS**



---

**Data Line****Check High State**

13.  SHIFT  SPCL  3  6  0  2  
(To specify high state.)
14.  4  3  HZ  
(To select bit.)
15. Connect VM probe to test connector line REF DATA (pin 14). (See Figure 3I-1. Cable Plug W4P2 Signal Locator.)
16.  2  5  HZ  
(To enable voltmeter.)
17. Voltage should read approximately +2.5 to +5.5 Vdc.  
( 5  HZ) to repeat measurement.)

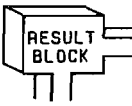
**Check Low State**

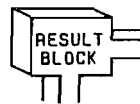
18.  SHIFT  SPCL  3  6  0  1  
(To specify low state.)
19.  4  3  HZ  
(To select bit.)
20.  2  5  HZ  
(To enable voltmeter.)
21. Voltage should read approximately -0.5 to +1.5 Vdc.  
( 5  HZ) to repeat measurement.)
22. Record test results.
23. Return to foldout:
  - Determine next task by comparing test results to conditions shown in each  for TEST CONTROL BITS.



---

**A11 MODULE DIAGNOSTICS**

---

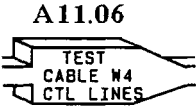
Type:	3; Bit Transmission	
Run time:	3 min.	
Set-up time:	3 min.	

Internal Voltmeter (VM) is used to measure TTL level changes transmitted to **A11 Module** on Clock and Data control lines.

**Run Test**

1. Switch instrument to **Standby**.
2. Extend **A11 Module** on extender posts, from On-Site Service Kit or instrument and disconnect cable **W4** from **A5 Assembly** at **A5J4**. (See table on foldout in **MECHANICAL PROCEDURES** to locate **A11 Module** extension and **A5** cable disconnection information.)
3. Connect **VM** probe:
  - Connect red alligator clip and retractable hook probe to red test lead provided in On-Site Service Kit.
  - Connect alligator clip to **VM IN (A4TP1)**. (See **A11 MODULE CABLE CONNECTION LOCATOR** on fold-out for **VM IN** location.)
4. Turn instrument on.

**Clock Line****Check High State**

5.        
(To specify high state.)

**NOTE**

*A "0" will appear in display indicating that the data bit will be set low. However, the bit is inverted in the Control Section before it is sent to A11.*

6.     
(To select bit.)
-

**A11 MODULE DIAGNOSTICS**

- 7. Connect VM probe to solder-side of A5J4, line REF CLK (pin 12). (See Figure 3I-2. A5J4 Signal Locator.)

**Figure 3I-2. A5J4 Signal Locator (Solder-Side View)**

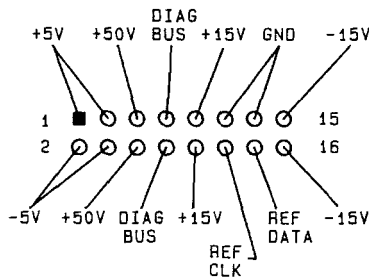

- 8.    (To enable voltmeter.)
- 9. Voltage should read approximately +2.5 to +5.5 Vdc.   to repeat measurement.)

**Check Low State**

- 10.       (To specify low state.)

**NOTE**

*A "1" will be displayed indicating that the data bit will be set high. However, the bit is inverted in the Control Section before it is sent to A11.*

- 11.    (To select bit.)
- 12.    (To enable voltmeter.)
- 13. Voltage should read approximately -0.5 to +1.5 Vdc.   to repeat measurement.)



---

**A11 MODULE DIAGNOSTICS**



---

**Data Line****Check High State**

14. **SHIFT** **SPCL** **3** **6** **0** **2**  
(To specify high state.)
15. **4** **3** **HZ**  
(To select bit.)
16. Connect VM probe to solder-side of **A5J4**, line **REF DATA** (pin 14). (See Figure 3I-2. **A5J4** Signal Locator.)
17. **2** **5** **HZ**  
(To enable voltmeter.)
18. Voltage should read approximately **+2.5** to **+5.5** Vdc.  
(**5** **HZ** to repeat measurement.)

**Check Low State**

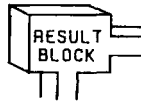
19. **SHIFT** **SPCL** **3** **6** **0** **1**  
(To specify low state.)
20. **4** **3** **HZ**  
(To select bit.)
21. **2** **5** **HZ**  
(To enable voltmeter.)
22. Voltage should read approximately **-0.5** to **+1.5** Vdc.  
(**5** **HZ** to repeat measurement.)
23. Record test results.
24. Return to foldout:
  - Determine next task by comparing test results to conditions shown in each **CTL LINES**.

for **TEST CABLE W4**

---

**A11 MODULE DIAGNOSTICS**

---

Type:	4, Voltage Measurements	A11.07
Run time:	3 min.	
Set-up time:	2 min.	

Internal Voltmeter (VM) is used to check power supply levels at inputs to A11 Module.

**Run Test**

- Switch instrument to Standby:
  - Disconnect W4 from A11 at A11A1 J1.
  - Plug end of W4 into 16 pin test connector, from On-Site Service Kit.

**NOTE**

*Find arrowhead on test connector and align with arrowhead on cable plug W4P2.*

- Connect VM probe:
  - Connect red alligator clip and retractable hook probe to red test lead provided in On-Site Service Kit.
  - Connect alligator clip to VM IN (A4TP1). (See A11 MODULE CABLE CONNECTION LOCATOR on fold-out for VM IN location.)
- Turn instrument on and enter:  
 [SHIFT] [SPCL] [3] [2] [5] [HZ]  
 (To enable Internal Voltmeter.)

**A11 MODULE DIAGNOSTICS**

4. Measure voltage levels:
  - Connect VM probe to test connector pin for each power supply line (see Figure 3I-3. Cable Plug W4P2 Signal Locator).
  - [5] [HZ] (To make each voltage measurement.)

**Figure 3I-3. Cable Plug W4P2 Signal Locator**

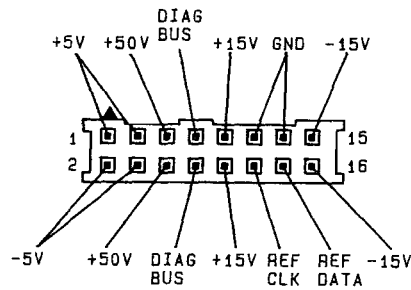

5. Record test results.
6. Return to foldout:
  - Determine next task by comparing test results to conditions shown in each

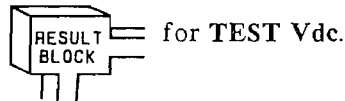

---

**A11 MODULE DIAGNOSTICS**

---

Type:	4, Voltage Measurements	A11.08
Run time:	3 min.	
Set-up time:	3 min.	

Internal Voltmeter (VM) is used to check power supply levels at **A5J4**.

### Run Test

1. Switch instrument to **Standby**.
2. Extend **A11 Module** on extender posts, from On-Site Service Kit or instrument and disconnect cable **W4** from **A5 Assembly** at **A5J4**. (See table on foldout in **MECHANICAL PROCEDURES** to locate **A11 Module** extension and **A5** cable disconnection information.)
3. Connect **VM** probe:
  - Connect red alligator clip and pointed tip probe to red test lead provided in On-Site Service Kit.
  - Connect alligator clip to **VM IN (A4TP1)**. (See **A11 MODULE CABLE CONNECTION LOCATOR** on foldout for **VM IN** location.)
4. Turn instrument on and enter:  
       
 (To enable Internal Voltmeter.)
5. Measure voltage levels at **A5J4**:
  - Access signals from solder-side of **A5J4**. (See **Figure 3I-4, A5J4 Signal Locator**.) It may be necessary to extend the **A11 Module** to access the solder-side of **A5J4**. (Refer to table on foldout in **MECHANICAL PROCEDURES** for information.)
  - (To make each voltage measurement.)

**A11 MODULE DIAGNOSTICS**

---

**Figure 3I-4. A5J4 Signal Locator  
(Solder-Side View)**

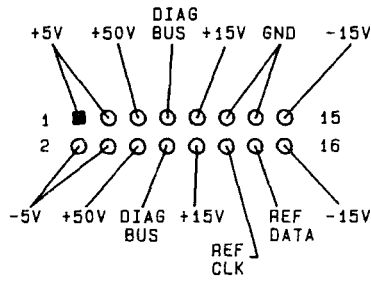

6. Record test results.
7. Return to foldout:
  - Determine next task by comparing test results to conditions shown in each **PS LINES**.

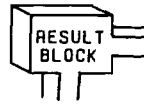

for **TEST CABLE W4**

---

**A11 MODULE DIAGNOSTICS**

---

Type:	1; Loop Lock/Unlock	A11.09
Run time:	15 sec.	
Set-up time:	0	

**Run Test**

1. **INSTR PRESET** **SHIFT**  
 (Hold shift key until "100.00000MZ -140.0DM" appears, to override 20 second reset test.)
2. **SHIFT** **SPCL** **3** **3** **2** **9** **HZ**.
3. When "DIAG DONE HIT MSSG.V1" appears:
  - Use **MSSG** to scroll through messages.
  - Record error code(s) displayed for A11. If "TEST 1 OF A11 (PASSED or FAILED)" is not displayed, rerun test.

**COMMENT**

*If any error codes are displayed for modules A01-A09, you need to isolate those failure(s) before performing the A11 MODULE SUBSTITUTION. (Refer to INSTRUMENT LEVEL DIAGNOSTICS to determine correct order for troubleshooting modules.)*

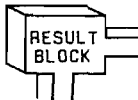
4. Return to foldout:
  - Determine next task by comparing test results to conditions shown in each  for TEST A11 MODULE.

---

**A11 MODULE DIAGNOSTICS**

---

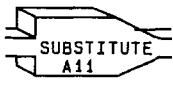
<b>Type:</b>	Module Substitution	<b>A11.10</b>
<b>Run time:</b>	0	
<b>Set-up time:</b>	5 min.	

The following describes the technique for connecting a known good A11 Module **without removing** the A11 module in the instrument.

**Connect Substitute Module**

1. Switch instrument to Standby.
2. Disconnect cables **W4**, **W24**, **W25** and **W31** from **A11 Module** (see **A11 MODULE CABLE CONNECTION LOCATOR** on foldout).
3. Without removing **A11 Module** from instrument, carefully lay substitute **A11 Module** on top of modules **A6**, **A7** and **A9**.

CAUTION

*When connecting ribbon cable, find arrowhead on cable connector and align with arrowhead on board connector.*

4. Connect cables **W4**, **W24**, **W25** and **W31** to substitute module.

**Down-Load Cal Data**

CAUTION

*Use adequate Electrostatic Discharge Techniques when handling the A20 Calibration Module.*

5. Remove from On-Site Service Kit **A20 Calibration Module** provided for substitute A11 Module.
-

---

**A11 MODULE DIAGNOSTICS**

---

**CAUTION**

*Check that switch SI on A20 Module is switched up to its "PROTECTED" position.*

6. With instrument switched to **Standby**, connect **A20 Module** to **A3 Module** at **A3J3** (see **A11 MODULE CABLE CONNECTION LOCATOR** on foldout).
7. Turn instrument on.
8. When "**100.000000 MZ -140.00 DM**" appears:
  - Slide switch on left side of **A3S2** on **A3 Module** back toward rear of instrument (see **A11 MODULE CABLE CONNECTION LOCATOR** on foldout).
9. **SHIFT** **SPCL** **3** **7** **3** **1** **HZ**
10. When "**TRANSFER VERIFIED .U613**" appears:
  - Slide **A3S2** forward toward front of instrument to protect **A3 Module's** memory.
11. Switch Instrument to **Standby** and remove **A20 Module**. Replace **A20 Module** in **On-Site Service Kit**.
12. Return to foldout.



---

**A11 MODULE DIAGNOSTICS**

---

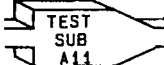
Type:	Substitute Module Test	<b>A11.11</b>
Run time:	1 min.	
Set-up time:	0	

Test operation of **substitute A11 Module** by repeating test performed on A11 Module before substitution.

**Run Test**

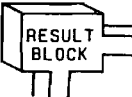
1. **INSTR PRESET** **SHIFT**  
(Hold shift key until "100.000000MZ -140.0DM" appears, to override 20 second reset test.)
2. **SHIFT** **SPCL** **3** **3** **2** **9** **HZ**.
3. When "DIAG DONE HIT MSSG.V1" appears:
  - Use **MSSG** to scroll through messages.
  - Record error code(s) displayed for **A11**. If "TEST 1 OF A11 (passed or failed)" is not displayed, rerun test.
4. Return to foldout:
  - Determine next task by comparing test results to conditions shown in each  for **TEST SUB A11**.

---

**A11 MODULE DIAGNOSTICS**

---

Type:	Additional A11 Tests	<b>A11.12</b>
Run time:	Conditional	
Set-up time:	Conditional	

The **A11** failure conditions for arriving at this task are described below. Follow the procedure for the condition which fits your module.

- Condition 1:** Instrument Level Self Test indicated A11 failure.
- Condition 2:** A12 Module RF Power Test indicated A11 failure.
- Condition 3:** Instrument must be set to a specific operating condition to detect A11 failure.

**Condition 1**

1.    
(Hold shift key until "100.000000MZ -140.0DM" appears, to override 20 second reset test.)
2.      .
3. When "WAITING FOR SET-UP 1 .V24" appears:
  - Connect BNC Tee connector, from On-Site Service Kit, to "FM/ΦM INPUT" (see INSTRUMENT LEVEL DIAGNOSTICS foldout for set-up diagram).
  - Connect a coax cable from Tee connector to "MOD OUTPUT".
  - Connect a coax cable from Tee to "AM/PULSE INPUT"
4. When "DIAG DONE HIT MSSGS .VI" appears:
  - Use  to scroll through messages.
  - Record **A11** error codes.

**COMMENT**

*If any error codes are displayed for modules A01-A09, you need to isolate those failure(s) before performing the A11 MODULE SUBSTITUTION. (Refer to INSTRUMENT LEVEL DIAGNOSTICS to determine correct order for troubleshooting modules.)*

5. Return to foldout.
-

---

### A11 MODULE DIAGNOSTICS

---

Condition 2

1.    
 (Hold shift key until "100.000000MZ -140.0DM" appears, to override 20 second reset test.)
2.
3. When "WAITING FOR SET-UP 1 .V24" appears:
  - Disconnect cable W25 from module at A11A3 J4.
  - Connect YELLOW PM cable and adapter to cable W25.
  - to continue test.
4. When "WAITING FOR SET-UP 2 .V25" appears:
  - Reconnect cable W25 to module at A11A3 J4.
  - Disconnect cable W24 from module at A11A1 J3.
  - Connect PM cable to module at A11A1 J3.
  - to continue test.
5. When "WAITING FOR SET-UP 3 .V26" appears:
  - Reconnect cable W24 to module at A11A1 J3.
  - Disconnect cable W31 from module at A11A3 J2.
  - Connect PM cable to module at A11A3 J2.
  - to continue test.
6. When "RECONNECT ALL CABLES .V29" appears:
  - Reconnect cable W31 to module at A11A3 J2.
  - to continue test.
7. When "DIAG DONE HIT MSSGS .V1" appears:
  - Use  to scroll through messages.
  - Record error code(s) displayed for A11.
8. Return to foldout.

Condition 3

1. Set instrument to operating condition which causes A11 failure.
  2. Record instrument set-up and error message(s).
  3. Return to foldout.
-

**A11 MODULE DIAGNOSTICS**

<b>Type:</b>	Additional Substitute A11 Tests	
<b>Run time:</b>	Conditional	
<b>Set-up time:</b>	Conditional	

Test operation of substitute A11 Module by repeating test(s) performed on A11 Module before substitution.

- Condition 1:** Instrument Level Self Test indicated A11 failure.
- Condition 2:** A12 Module RF Power Test indicated A11 failure.
- Condition 3:** Instrument must be set to a specific operating condition to detect A11 failure.

Condition 1

1. **[INSTR PRESET] [SHIFT]**  
(Hold shift key until "100.000000MZ -140.0DM" appears, to override 20 second reset test.
2. **[SHIFT] [SPCL] [3] [3] [0] [HZ]**.
3. When "WAITING FOR SET-UP 1 .V24" appears:
  - Connect BNC Tee connector, from On-Site Service Kit, to "FM/ΦM INPUT" (see INSTRUMENT LEVEL DIAGNOSTICS foldout for set-up diagram).
  - Connect a coax cable from Tee connector to "MOD OUTPUT".
  - Connect a coax cable from Tee to "AM/PULSE INPUT"
4. When "DIAG DONE HIT MSSGS .VI" appears:
  - Use **[MSSG]** to scroll through messages.
  - Record **A11** error codes.

**COMMENT**

*If any error codes are displayed for modules A01-A09, you need to isolate those failure(s) now.*

5. Return to foldout.
  - Determine next task by comparing test results to conditions shown in each **FURTHER.**

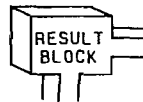

for **TEST SUB A11**

**A11 MODULE DIAGNOSTICS**

---

**Condition 2**

1. **INSTR PRESET** **SHIFT**  
 (Hold shift key until "100.000000MZ -140.0DM" appears, to override 20 second reset test.)
2. **SHIFT** **SPCL** **3** **3** **3** **1** **HZ**
3. When "WAITING FOR SET-UP 1 .V24" appears:
  - Disconnect cable **W25** from module at **A11A3 J4**.
  - Connect **YELLOW PM** cable and adapter to cable **W25**.
  - **HZ** to continue test.
4. When "WAITING FOR SET-UP 2 .V25" appears:
  - Reconnect cable **W25** to module at **A11A3 J4**.
  - Disconnect cable **W24** from module at **A11A1 J3**.
  - Connect **PM** cable to module at **A11A1 J3**.
  - **HZ** to continue test.
5. When "WAITING FOR SET-UP 3 .V26" appears:
  - Reconnect cable **W24** to module at **A11A1 J3**.
  - Disconnect cable **W31** from module at **A11A3 J2**.
  - Connect **PM** cable to module at **A11A3 J2**.
  - **HZ** to continue test.
6. When "RECONNECT ALL CABLES .V29" appears:
  - Reconnect cable **W31** to module at **A11A3 J2**.
  - **HZ** to continue test.
7. When "DIAG DONE HIT MSSGS .V1" appears:
  - Use **MSSG** to scroll through messages.
  - Record error code(s) displayed for **A11**.
8. Return to foldout:
  - Determine next task by comparing test results to conditions shown in each **RESULT BLOCK** for **TEST SUB A11 FURTHER**.

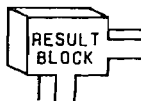

**Condition 3**

1. Set instrument to operating condition which causes **A11** failure.
2. Record instrument set-up and error message(s).
3. Return to foldout:
  - Determine next task by comparing test results to conditions shown in each **RESULT BLOCK** for **TEST SUB A11 FURTHER**.

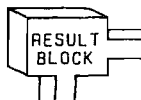

---

**A11 MODULE DIAGNOSTICS**

---

Type:	Module Replacement	A11.14
Run time:	10 sec.	
Set-up time:	5 min.	

**Connect Module**

1. Switch instrument to Standby.
2. Disconnect cables **W4**, **W24**, **W25** and **W31** from substitute **A11 Module**.

**CAUTION**

*When connecting ribbon cable, find arrowhead on cable connector and align with arrowhead on board connector.*

3. Reconnect cables **W4**, **W24**, **W25** and **W31** to **A11 Module**.
4. Return substitute **A11 Module** to On-Site Service Kit.

**Down-Load Cal Data****CAUTION**

*Use adequate Electrostatic Discharge Techniques when handling the **A20 Calibration Module**.*

5. After making sure that **A20 Module** for substitute **A11 Module** has been returned to On-Site Service Kit, remove **A20 Calibration Module** from Rear Panel (see **MECHANICAL PROCEDURES** for removal information).

---

**A11 MODULE DIAGNOSTICS**

---

**CAUTION**

*Check that switch S1 on A20 Module is switched up to its "PROTECTED" position.*

6. With instrument switched to **Standby**, connect **A20 Module** to **A3 Module** at **A3J3**.
7. Turn instrument on.
8. When "**100.000000 MZ -140.00 DM**" appears:
  - Slide switch on left side of **A3S2** on **A3 Module** back toward rear of instrument.
9. **SHIFT** **SPCL** **3** **7** **3** **1** **HZ**
10. When "**TRANSFER VERIFIED .U613**" appears:
  - Slide **A3S2** forward toward front of instrument to protect **A3 Module's** memory.
11. Switch Instrument to **Standby** and remove **A20 Module**.  
**Replace A20 Module on Rear Panel.**
12. Return to foldout.

---

**A11 MODULE DIAGNOSTICS**

---

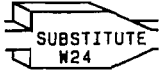
<b>Type:</b>	Cable Substitution	<b>A11.15</b>
<b>Run Time:</b>	5 min.	
<b>Set-up Time:</b>	1 min.	

1. Testing has shown cable **W24** or **W25** to be suspect, temporarily replace it with a test cable from the On-Site Service Kit. Rerun **INSTRUMENT LEVEL DIAGNOSTICS (ILD)** to confirm repair.
2. Refer to **REPLACEABLE PARTS**, in HP 8642A/B Operating and Service Manual, for information to order a permanent replacement cable.
3. Return to foldout.



---

**A11 MODULE DIAGNOSTICS**

---

Type:	Cable Substitution	<b>A11.16</b>
Run time:	0 min.	
Set-up time:	3 min.	

Testing has shown cable **W4** to be suspect, temporarily replace with a spare ribbon cable if available. Rerun **INSTRUMENT LEVEL DIAGNOSTICS (ILD)** to confirm repair.

Refer to **REPLACEABLE PARTS**, in HP 8642A/B Operating and Service Manual, for information to order a permanent replacement cable.

CAUTION

*When connecting ribbon cable to A11 Module, find arrowhead on the cable plug and align with arrowhead on the board connector.*

**Reconnect W4**

1. Switch instrument to **Standby** to connect cable **W4** to **A5 Assembly** and **A11 Module**. (Refer to table on foldout in **MECHANICAL PROCEDURES** for information on connecting cable **W4** to **A5J2**.)
2. Return to foldout.

---

**A11 MODULE DIAGNOSTICS**

---

Type:	Cable Connection	A11.17
Run time:	0 min.	
Set-up time:	3 min.	

**CAUTION**

*When connecting ribbon cable to A11 Module, find arrowhead on the cable plug and align with arrowhead on the board connector.*

**Reconnect W4**

1. Switch instrument to **Standby** to reconnect cable **W4** to **A5** Assembly or **A11** Module. (Refer to table on foldout in **MECHANICAL PROCEDURES** for information on reconnecting cable **W4** to **A5J2**.)
2. Return to foldout.

---

**A11 THEORY OF OPERATION**

---

**3I-4. A11 REFERENCE LOOP MODULE****COMMENT**

*It is not to essential to understand the internal operation of a module to make an on-site repair.*

The **A11 Module** contains a phase lock loop which combines the **A6 FM Loop** output signal (the angle modulation source of the instrument) with the **A7 SAWR Loop** output (one of three UHF reference frequencies) to produce six UHF reference frequencies.

The output of the **A11 Module** is divided into two bands. Each band is generated by a separate voltage controlled oscillator (VCO).

Each of the three upper band frequencies is equal to the sum of the **A6 Module** output signal (135 MHz, plus FM or PM) and one of the three **A7 Module** output frequencies (742.5, 787.5 or 822.5 MHz).

The three lower band frequencies are equal to the difference between the **A6** and **A7 Modules** output frequencies; i.e.,  $607.5 = 742.5 - 135$ .

The **A11 Module** output is the UHF reference for the **A12 Sum Loop/Divider Module**.

See the **A11 MODULE SIMPLIFIED BLOCK DIAGRAM** for further understanding of the **A11 Modules** internal operation.

---

---

**A12 SUM LOOP/DIVIDER MODULE**

---

**3J-1. INTRODUCTION**

The **MODULE LEVEL DIAGNOSTICS (MLD)** contained in this section are used to further interrogate the **A12 Module**. The objective is to isolate the failure indicated for this module to the module itself or to a part on which it depends for operation.

**NOTE**

*At this level of testing, recommendations for further action are made on the assumption that the **INSTRUMENT LEVEL DIAGNOSTICS (ILD)** showed no failures for modules **A01-A11**. (For information on using the on-site diagnostics, refer to the **INTRODUCTION** section of this manual.)*

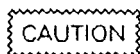

*When tightening the coax cable connectors, do not exceed a torque of 1.0 Nm or .74 ft-lbs (slightly tighter than finger tight).*

*When coax cables are disconnected from instrument, do not allow loose ends to come in contact with any exposed circuitry susceptible to short circuiting.*

**Test Instructions**

1. The instrument's **Top Cover** must be removed to run many of these tests. (Refer to the table shown on the foldout in **MECHANICAL PROCEDURES** to locate instructions.)
2. The last page in this group of tests is a foldout and should be pulled out now.
3. Turn to the next page to begin the **A12 MLD**.

---

## A12 INPUTS VERIFICATION

---

### 3J-2. INTRODUCTION

The first step in isolating a failure in the **A12 Module** is to verify correct operation of each input signal. Use the **A12 INPUTS VERIFICATION** procedure to check each signal path into the **A12 Module**.

#### A12 Inputs Verification Instructions

1. Find **A12 INPUTS VERIFICATION** on the foldout.
2. The Task Sequence Diagrams, shown under **A12 INPUTS VERIFICATION**, are separated into three checks: **RF**, **Control** and **Power Supply** signals.
3. Use the Task Sequence Diagrams to direct you through the verification process. Each Task Arrow shown in a diagram indicates a task title and task number. The tasks are numbered according to the order in which they are arranged in this section. Turn to the page indicated and complete the procedure.
4. After completing the procedure, return to the Task Sequence Diagram on the foldout and determine the next task to be performed.
5. Begin now by performing the first task shown under **1. A12 RF INPUT CHECK**.

#### NOTE

*The **A12 MODULE I/O SIGNALS DIAGRAM** shows all parts which the **A12 Module** depends on for operation.*

---

**A12 MODULE SUBSTITUTION**

---

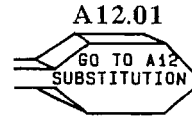
**3J-3. INTRODUCTION**

If you were unable to isolate the failure using the **A12 INPUTS VERIFICATION** procedure, then follow the Task Sequence Diagram, shown under **A12 MODULE SUBSTITUTION**, to substitute in a known good module from the On-Site Service Kit.

**A12 Substitution Instructions**

1. Find **A12 MODULE SUBSTITUTION** on the foldout.
2. Use the Task Sequence Diagram, shown under **A12 MODULE SUBSTITUTION**, to direct you through the substitution process. Each Task Arrow shown in the diagram indicates a task title and task number. The tasks are numbered according to the order in which they are arranged in this section. Turn to the task indicated and complete the procedure.
3. After completing the procedure, return to the Task Sequence Diagram on the foldout and determine the next task to be performed.
4. Begin now by performing the first task shown on the diagram.

**A12 MODULE DIAGNOSTICS**

Type:	2A; RF Power Levels	A12.02
Run time:	4 min.	
Set-up time:	3 min.	

RF signal level is measured using Internal Power Meter (PM).

**CAUTION**

*Do not permit end of Internal Power Meter cable to short circuit instrument by coming in contact with any exposed circuitry.*

**Run Test**

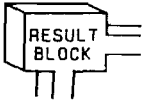
1. **INSTR PRESET** **SHIFT**  
 (Hold shift key until "100.000000MZ -140.0DM" appears, to override 20 second reset test.)
2. **SHIFT** **SPCL** **3** **6** **8** **1** **3** **HZ**  
 (To check input levels only.)
3. **3** **4** **5** **HZ**.
4. When "WAITING FOR SET-UP 1 .V24" appears:
  - Disconnect cable **W31** from module at **A12A2 J2**.
  - Connect **YELLOW PM** cable and adapter to cable **W31**.
  - **HZ** to continue test.
5. When "WAITING FOR SET-UP 2 .V25" appears:
  - Reconnect cable **W31** to module at **A12A2 J2**.
  - Disconnect cable **W30** from module at **A12A3 J6**.
  - Connect **YELLOW PM** cable and adapter to cable **W30**.
  - **HZ** to continue test.
6. When "RECONNECT ALL CABLES .V29" appears:
  - Reconnect cable **W30** to module at **A12A3 J6**.
  - **HZ** to continue test.
7. When "DIAG DONE HIT MSSGS .V1" appears:
  - Use **MSSG** to scroll through messages.
  - Record test results.
8. Return to foldout:
  - Determine next task by comparing test results to conditions shown in each  for **TEST RF POWER**.

**A12 MODULE DIAGNOSTICS**

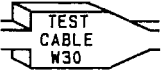
Type:	2A; RF Power Levels	A12.03
Run time:	4 min.	
Set-up time:	2 min.	

RF signal level is measured using Internal Power Meter (PM).

**Run Test**

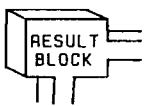
1.    
 (Hold shift key until "100.000000MZ -140.0DM" appears, to override 20 second reset test.)
2.          
 (To check input levels only.)
3.
4. When "WAITING FOR SET-UP 1 .V24" appears:
  - Disconnect cable W31 from A11 Module at A11A3 J2. (See Top View Diagram inside Top Cover to locate W31 connection on A11 Module.)
  - Connect YELLOW PM cable to module at A11A3 J2.
  - to continue test.
5. When "WAITING FOR SET-UP 2 .V25" appears:
  - Reconnect cable W31 to module at A11A3 J2.
  - Disconnect cable W30 from module at A9A1 J4.
  - Connect YELLOW PM cable to module at A9A1 J4.
  - to continue test.
6. When "RECONNECT ALL CABLES .V29" appears:
  - Reconnect cable W30 to module at A9A1 J4.
  - to continue test.
7. When "DIAG DONE HIT MSSGS .V1" appears:
  - Use  to scroll through messages.
  - Record test results.
8. Return to foldout:
  - Determine next task by comparing test results to conditions shown in each  for TEST CABLE W30.



---

**A12 MODULE DIAGNOSTICS**

---

Type:	2A; RF Power Levels	
Run time:	4 min.	
Set-up time:	2 min.	

A12.04

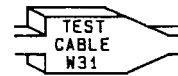

RF signal level is measured using Internal Power Meter (PM).

**Run Test**

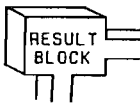
1.    
 Hold shift key until  
 "100.000000MZ -140.0DM" appears,  
 to override 20 second reset test.)
2.          
 (To check input levels only.)
3.
4. When "WAITING FOR SET-UP 1 .V24" appears:
  - Disconnect cable W31 from A11 Module at A11A3 J2.  
 (See Top View Diagram inside Top Cover to locate W31 connection on A11 Module.)
  - Connect **YELLOW PM** cable to module at A11A3 J2.
  - to continue test.
5. When "RECONNECT ALL CABLES .V29" appears:
  - Reconnect cable W31 to module at A11A3 J2.
  - to continue test.
6. When "DIAG DONE HIT MSSGS .V1" appears:
  - Use  to scroll through messages.
  - Record test results.
7. Return to foldout:
  - Determine next task by comparing test results to conditions shown in each  for TEST CABLE W31.

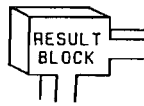

---

**A12 MODULE DIAGNOSTICS**

---

<b>Type:</b>	3; Bit Transmission	<b>A12.05</b>
<b>Run time:</b>	5 min.	
<b>Set-up time:</b>	5 min.	

Internal Voltmeter (VM) is used to measure TTL level changes transmitted to A12 Module on Clock, Data and Divider control lines.

**COMMENT**

*If any control line level is bad, it is not necessary to test remaining lines; proceed to step 24.*

**Run Test**

1. Switch instrument to **Standby**:

**NOTE**

*A12 Module must be lifted slightly to disconnect W5. Release module retaining clips (at each end of module) from slide posts. Lift module up high enough to disconnect W5.*

- Disconnect cable **W5** from module at **A12A3 J1**.
- Plug end of **W5** into **26 pin** test connector, from On-Site Service Kit.

**NOTE**

*Find arrowhead on test connector and align with arrowhead on cable plug **W5P2**.*

**CAUTION**

*To prevent damage to the Power Supply and Control sections, do not permit the exposed pins on the test connector to short circuit.*

2. Connect VM probe:
    - Connect red alligator clip and retractable hook probe to red test lead provided in On-Site Service Kit.
    - Connect alligator clip to **VM IN (A4TP1)**. (See **A12 MODULE CABLE CONNECTION LOCATOR** on fold-out for **VM IN** location.)
-

**A12 MODULE DIAGNOSTICS**

- Turn instrument on.

**Clock and Data Control Lines**

**Check High State**

- (To set bit high).

**NOTE**

*A "0" will appear in display indicating that the data bits will be set low. However, the bits are inverted in the Control Section before they are sent to A12.*

- Enter Bit Select Keys, as indicated in Table 3J-1. W5P2 Control Bits, for Control Line to be tested.
- Connect VM probe Control Line at Pin Number indicated in Table 3J-1. (See Figure 3J-1. Cable Plug W5P2 Signal Locator.)

**Table 3J-1. W5P2 Control Bits**

Test Order	Control Line	Bit Select Keys (Steps 5 and 10)	Pin Number (Step 6)
1	SUM CLK	<input type="button" value="4"/> <input type="button" value="4"/> <input type="button" value="HZ"/>	16
2	SUM DATA	<input type="button" value="4"/> <input type="button" value="5"/> <input type="button" value="HZ"/>	18

**Figure 3J-1. Cable Plug W5P2 Signal Locator**

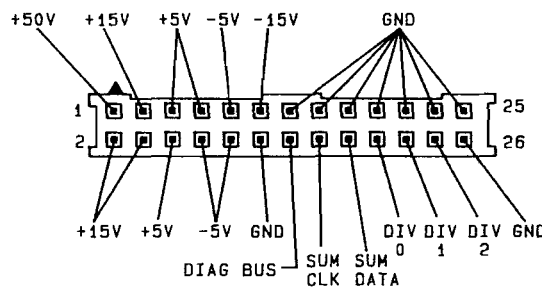

---

**A12 MODULE DIAGNOSTICS**

---

7.     
(To enable voltmeter.)
8. Voltage should read approximately +2.5 to +5.5 Vdc.  
(  to repeat measurement.)

**Check Low State**

9.        
(To set bit low.)

**NOTE**

*A "1" will appear in display indicating that the data bits will be set high. However, the bits are inverted in the Control Section before they are sent to A12.*

10. Enter **Bit Select Keys**, as indicated in **Table 3J-1. W5P2 Control Bits**, for same **Control Line**.
11.     
(To enable voltmeter.)
12. Voltage should read approximately -0.5 to +1.5 Vdc.  
(  to repeat measurement.)
13. Repeat procedure for each **Control Line** shown in **Table 3J-1**.

**Divider Control Lines****Check High State**

14.        
(To set bit high.)

**NOTE**

*This bit is not inverted in the Control Section before it is sent to A12.*

15. Enter **Bit Select Keys**, as indicated in **Table 3J-2. W5P2 Control Bits**, for **Control Line** to be tested.
  16. Connect **VM probe Control Line** at **Pin Number** indicated in **Table 3J-2**. (See **Figure 3J-1. Cable Plug W5P2 Signal Locator**.)
-

A12 MODULE DIAGNOSTICS

Table 3J-2. W5P2 Control Bits

Test Order	Control Line	Bit Select Keys (Steps 15 and 20)	Pin Number (Step 16)
1	DIV 0	[2] [7] [HZ]	20
2	DIV 1	[2] [8] [HZ]	22
3	DIV 2	[2] [9] [HZ]	24

17. [2] [5] [HZ]  
(To enable voltmeter.)

18. Voltage should read approximately +2.5 to +5.5 Vdc.  
([5] [HZ] to repeat message.)

Check Low State

19. [SHIFT] [SPCL] [3] [6] [0] [2]  
(To set bit low.)

20. Enter Bit Select Keys, as indicated in Table 3J-2. W5P2 Control Bits, for same Control Line.

21. [2] [5] [HZ]  
(To enable voltmeter.)

22. Voltage should read approximately -0.5 to +1.5 Vdc.  
([5] [HZ] to repeat measurement.)

23. Record test results.

24. Return to foldout:  
• Determine next task by comparing test results to conditions shown in each **RESULTS** block.

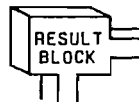

for TEST CONTROL

---

**A12 MODULE DIAGNOSTICS**

---

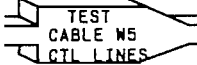
Type:	3; Bit Transmission	<b>A12.06</b> 
Run time:	5 min.	
Set-up time:	2 min.	

Internal Voltmeter (VM) is used to measure TTL level changes transmitted to A12 Module on Clock, Data and Divider control lines.

**Run Test**

1. Switch instrument to Standby.
2. Extend A12 Module on extender posts, from On-Site Service Kit or instrument, and disconnect cable W5 from A5 Assembly at A5J5. (See table on foldout in MECHANICAL PROCEDURES to locate A12 Module extension and A5 cable disconnection information.)
3. Connect VM probe:
  - ⊗ Connect red alligator clip and retractable hook probe to red test lead provided in On-Site Service Kit.
  - ⊗ Connect alligator clip to VM IN (A4TP1). (See A12 MODULE CABLE CONNECTION LOCATOR on foldout for VM IN location.)
4. Turn instrument on.

**COMMENT**

*It is only necessary to perform test on failing control line.*

**Clock and Data Control Lines****Check High State**

5.  SHIFT  SPCL  3  6  0  2  
 (To specify high state.)

**NOTE**

*A "0" will appear in display indicating that the data bits will be set low. However, the bits are inverted in the Control Section before they are sent to A12.*

---

**A12 MODULE DIAGNOSTICS**

6. Enter **Bit Select Keys**, as indicated in Table 3J-3. **A5J5 Control Bits**, for Control Line to be tested.
7. Connect **VM probe Control Line** at **Pin Number** indicated in Table 3J-3. (See Figure 3J-2. **A5J5 Signal Locator**.)

**Table 3J-3. A5J5 Control Bits**

Test Order	Control Line	Bit Select Keys (Steps 6 and 11)	Pin Number (Step 7)
1	SUM CLK	<input type="text" value="4"/> <input type="text" value="4"/> <input type="text" value="HZ"/>	16
2	SUM DATA	<input type="text" value="4"/> <input type="text" value="5"/> <input type="text" value="HZ"/>	18

**Figure 3J-2. A5J5 Signal Locator  
(Solder-Side View)**

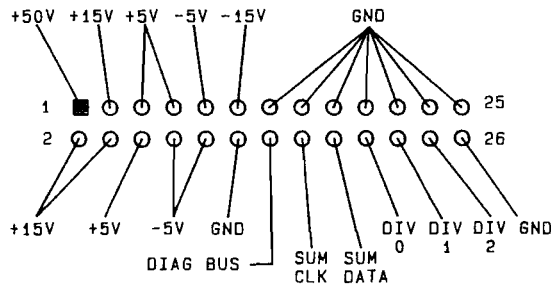

8.     
(To enable voltmeter.)
9. Voltage should read approximately +2.5 to +5.5 Vdc.  
  to repeat measurement.)

---

### A12 MODULE DIAGNOSTICS

---

**Check Low State**

10.        
 (To specify low state.)

**NOTE**

*A "1" will appear in display indicating that the data bits will be set high. However, the bits are inverted in the Control Section before they are sent to A12.*

11. Enter **Bit Select Keys**, as indicated in Table 3J-3. A5J5 Control Bits, for same Control Line.
12.     
 (To enable voltmeter.)
13. Voltage should read approximately **-0.5 to +1.5 Vdc**.  
  to repeat measurement.)

**Divider Control Lines****Check High State**

14.        
 (To set bit high.)

**NOTE**

*This bit is not inverted in the Control Section before it is sent to A12.*

15. Enter **Bit Select Keys**, as indicated in Table 3J-4. A5J5 Control Bits, for Control Line to be tested.
16. Connect VM probe Control Line at PIN NUMBER indicated in Table 3J-4. (See Figure 3J-2. A5J5 Signal Locator.)
-



**A12 MODULE DIAGNOSTICS**

**Table 3J-4. A5J5 Control Bits**

Test Order	Control Line	Bit Select Keys (Steps 15 and 20)	Pin Number (Step 16)
1	DIV 0	[2] [7] [HZ]	20
2	DIV 1	[2] [8] [HZ]	22
3	DIV 2	[2] [9] [HZ]	24

17. [2] [5] [HZ]  
(To enable voltmeter.)
18. Voltage should read approximately **+2.5 to +5.5 Vdc**.  
([5] [HZ] to repeat message.)

**Check Low State**

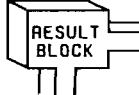
19. [SHIFT] [SPCL] [3] [6] [0] [2]  
(To set bit low.)
20. Enter **Bit Select Keys**, as indicated in **Table 3J-4. A5J5 Control Bits**, for same **Control Line**.
21. [2] [5] [HZ]  
(To enable voltmeter.)
22. Voltage should read approximately **-0.5 to +1.5 Vdc**.  
([5] [HZ] to repeat measurement.)
23. Record test results.
24. Return to foldout:
  - Determine next task by comparing test results to conditions shown in each  for **TEST CABLE W5 CTL LINES**.

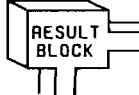

---

**A12 MODULE DIAGNOSTICS**

---

<b>Type:</b>	4, Voltage Measurements	<b>A12.07</b>
<b>Run time:</b>	3 min.	
<b>Set-up time:</b>	3 min.	

Internal Voltmeter (VM) is used to check power supply levels at inputs to A12 Module.

**Run Test**

1. Switch instrument to Standby:

**NOTE**

*A12 Module must be lifted slightly to disconnect W5. Release module retaining clips (at each end of module) from slide posts. Lift module up high enough to disconnect W5.*

- Disconnect W5 from A12 at A12A3 J1.
- Plug end of W5 into 26 pin test connector, from On-Site Service Kit.

**NOTE**

*Find arrowhead on test connector and align with arrowhead on cable plug W5P2.*

2. Connect VM probe:
  - Connect red alligator clip and retractable hook probe to red test lead provided in On-Site Service Kit.
  - Connect alligator clip to VM IN (A4TP1). (See A12 MODULE CABLE CONNECTION LOCATOR on fold-out for VM IN location.)
3. Turn instrument on and enter:  
 (SHIFT) (SPCL) (3) (2) (5) (HZ)  
 (To enable Internal Voltmeter.)

**A12 MODULE DIAGNOSTICS**

---

4. Measure voltage levels:
  - Connect VM probe to test connector pin for each power supply line (see Figure 3J-3. Cable Plug W5P2 Signal Locator).
  - **5** **HZ** (To make each voltage measurement.)

**Figure 3J-3. Cable Plug W5P2 Signal Locator**

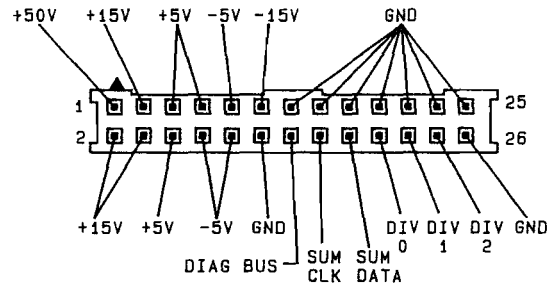

5. Record test results.
6. Return to foldout:
  - Determine next task by comparing test results to conditions shown in each

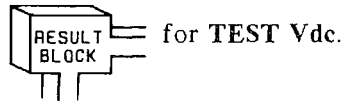

---

**A12 MODULE DIAGNOSTICS**

---

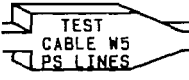
Type:	4, Voltage Measurements	<b>A12.08</b>
Run time:	3 min.	
Set-up time:	3 min.	

Internal Voltmeter (VM) is used to check power supply levels at A5J5.

### Run Test

1. Switch instrument to **Standby**.
  2. Extend **A12 Module** on extender posts, from On-Site Service Kit, and disconnect cable **W5** from **A5 Assembly** at **A5J5**. (See table on foldout in **MECHANICAL PROCEDURES** to locate **A12 Module** extension and **A5** cable disconnection information.)
  3. Connect **VM** probe:
    - Connect red alligator clip and pointed tip probe to red test lead provided in On-Site Service Kit.
    - Connect alligator clip to **VM IN (A4TP1)**. (See **A12 MODULE CABLE CONNECTION LOCATOR** on foldout for **VM IN** location.)
  4. Turn instrument on and enter:  
       
 (To enable Internal Voltmeter.)
  5. Measure voltage levels at **A5J5**:
    - Access signals from solder-side of **A5J5**. (See **Figure 3J-4, A5J5 Signal Locator**.)
    - (To make each voltage measurement.)
-

A12 MODULE DIAGNOSTICS

Figure 3J-4. A5J5 Signal Locator  
(Solder-Side View)

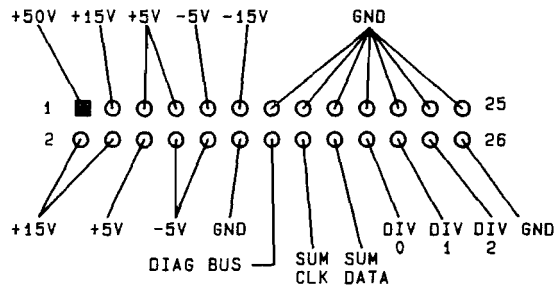

6. Record test results.
7. Return to folout:
  - Determine next task by comparing test results to conditions shown in each PS LINES.

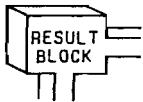

for TEST CABLE W5

**A12 MODULE DIAGNOSTICS**

---

Type:	1; Loop Lock/Unlock	<b>A12.09</b>
Run time:	40 sec.	
Set-up time:	0	

**Run Test**

1. **INSTR PRESET** **SHIFT**  
 (Hold shift key until "100.00000MZ -140.0DM" appears, to override 20 second reset test.)
2. **SHIFT** **SPCL** **3** **3** **4** **1** **HZ**.
3. When "**DIAG DONE HIT MSSG .V1**" appears:
  - Use **MSSG** to scroll through messages.
  - Record error code(s) displayed for **A12**.

**COMMENT**

*If any error codes are displayed for modules A01-A11, you need to isolate those failure(s) before performing the A12 MODULE SUBSTITUTION. (Refer to INSTRUMENT LEVEL DIAGNOSTICS to determine correct order for troubleshooting modules.)*

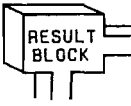
4. Return to foldout:
  - Determine next task by comparing test results to conditions shown in each  for **TEST A12 MODULE**.

---

### A12 MODULE DIAGNOSTICS

---

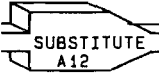
<b>Type:</b>	Module Substitution	<b>A12.10</b>
<b>Run time:</b>	10 sec.	
<b>Set-up time:</b>	5 min.	

The following describes the technique for connecting a known good A12 Module without removing the A12 module in the instrument.

#### Connect Substitute Module

1. Switch instrument to **Standby**.
2. Disconnect cables **W5**, **W30**, **W31** and **W33** from **A12 Module** (see **A12 MODULE CABLE CONNECTION LOCATOR** on foldout).
3. Without removing **A12 Module** from instrument, carefully lay substitute **A12 Module** on top of modules **A7**, **A9** and **A11**.

CAUTION

*When connecting ribbon cable, find arrowhead on cable connector and align with arrowhead on board connector.*

4. Connect cables **W5**, **W30**, **W31** and **W33** to substitute module.

#### Down-Load Cal Data

CAUTION

*Use adequate Electrostatic Discharge Techniques when handling the A20 Calibration Module.*

5. Remove from On-Site Service Kit, **A20 Calibration Module** provided for substitute A12 Module.
-

---

**A12 MODULE DIAGNOSTICS**

---

CAUTION

*Check that switch S1 on A20 Module is switched up to its "PROTECTED" position.*

6. With instrument switched to Standby, connect A20 Module to A3 Module at A3J3 (see A12 MODULE CABLE CONNECTION LOCATOR on foldout).
7. Turn instrument on.
8. When "100.000000 MZ -140.00 DM" appears:
  - Slide switch on left side of A3S2 on A3 Module back toward rear of instrument (see A12 MODULE CABLE CONNECTION LOCATOR on foldout).
9. SHIFT SPCL 3 7 3 2 HZ
10. When "TRANSFER VERIFIED .U613" appears:
  - Slide A3S2 forward toward front of instrument to protect A3 Module's memory.
11. Switch Instrument to Standby and remove A20 Module. Replace A20 Module in On-Site Service Kit.
12. Return to foldout.



---

**A12 MODULE DIAGNOSTICS**

---

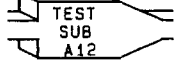
Type:	Substitute Module Test	<b>A12.11</b>
Run time:	1 min.	
Set-up time:	0	

Test operation of substitute A12 Module by repeating test performed on A12 Module before substitution.

**Run Test**

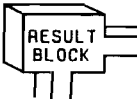
1. **INSTR PRESET** **SHIFT**  
 (Hold shift key until "100.000000MZ -140.0DM" appears, to override 20 second reset test.)
2. **SHIFT** **SPCL** **3** **3** **4** **1** **HZ**.
3. When "**DIAG DONE HIT MSSG .V1**" appears:
  - Use **MSSG** to scroll through messages.
  - Record error code(s) displayed for A12.
4. Return to foldout:
  - Determine next task by comparing test results to conditions shown in each  for **TEST SUB A12**.

---

**A12 MODULE DIAGNOSTICS**

---

Type:	Additional A12 Tests	A12.12
Run time:	Conditional	
Set-up time:	Conditional	

The A12 failure conditions for arriving at this task are described below. Follow the procedure for the condition which fits your module.

- Condition 1: Instrument Level Self Test indicated A12 failure.
- Condition 2: A13 Module RF Power Test indicated A12 failure.
- Condition 3: Instrument must be set to a specific operating condition to detect A12 failure.

#### Condition 1

1.    
 (Hold shift key until "100.000000MZ -140.0DM" appears, to override 20 second reset test.
2.      .
3. When "WAITING FOR SET-UP 1 .V24" appears:
  - Connect BNC Tee connector, from On-Site Service Kit, to "FM/ΦM INPUT" (see INSTRUMENT LEVEL DIAGNOSTICS foldout for set-up diagram).
  - Connect a coax cable from Tee connector to "MOD OUTPUT".
  - Connect a coax cable from Tee to "AM/PULSE INPUT"
4. When "DIAG DONE HIT MSSGS.VI" appears:
  - Use  to scroll through messages.
  - Record A12 error codes.

#### COMMENT

*If any error codes are displayed for modules A01-A11, you need to isolate those failure(s) before performing the A12 MODULE SUBSTITUTION. (Refer to INSTRUMENT LEVEL DIAGNOSTICS to determine correct order for troubleshooting modules.)*

5. Return to foldout.
-

---

**A12 MODULE DIAGNOSTICS**

---

**Condition 2**

1.    
 (Hold shift key until "100.000000MZ -140.0DM" appears, to override 20 second reset test.)
2.
3. When "WAITING FOR SET-UP 1 .V24" appears:
  - Disconnect cable W31 from module at A12A2 J2.
  - Connect YELLOW PM cable and adapter to cable W31.
  - to continue test.
4. When "WAITING FOR SET-UP 2 .V25" appears:
  - Reconnect cable W31 to module at A12A2 J2.
  - Disconnect cable W30 from module at A12A3 J6.
  - Connect PM cable and adapter to W30.
  - to continue test.
5. When "WAITING FOR SET-UP 3 .V26" appears:
  - Reconnect cable W30 to module at A12A3 J6.
  - Disconnect cable W32 from module at A12A3 J3.
  - Connect PM cable to module at A12A3 J3.
  - to continue test.
6. When "RECONNECT ALL CABLES .V29" appears:
  - Reconnect cable W32 to module at A12A3 J3.
  - to continue test.
7. When "DIAG DONE HIT MSSGS .V1" appears:
  - Use  to scroll through messages.
  - Record error code(s) displayed for A12.
8. Return to foldout.

**Condition 3**

1. Set instrument to operating condition which causes A12 failure.
  2. Record instrument set-up and error message(s).
  3. Return to foldout.
-

**A12 MODULE DIAGNOSTICS**

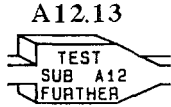
Type:	Additional Substitute	
Run time:	A12 Tests	
Set-up time:	Conditional	

Test operation of substitute A12 Module by repeating test(s) performed on A12 Module before substitution.

- Condition 1: Instrument Level Self Test indicated A12 failure.
- Condition 2: A13 Module RF Power Test indicated A12 failure.
- Condition 3: Instrument must be set to a specific operating condition to detect A12 failure.

**Condition 1**

1. **INSTR PRESET** **SHIFT**  
 (Hold shift key until "100.000000MZ -140.0DM" appears, to override 20 second reset test.
2. **SHIFT** **SPCL** **3** **3** **0** **HZ**.
3. When "WAITING FOR SET-UP 1 .V24" appears:
  - Connect BNC Tee connector, from On-Site Service Kit, to "FM/ΦM INPUT" (see INSTRUMENT LEVEL DIAGNOSTICS foldout for set-up diagram).
  - Connect a coax cable from Tee connector to "MOD OUTPUT".
  - Connect a coax cable from Tee to "AM/PULSE INPUT"
4. When "DIAG DONE HIT MSSGS .VI" appears:
  - Use **MSSG** to scroll through messages.
  - Record A12 error codes.

**COMMENT**

*If any error codes are displayed for modules A01-A11, you need to isolate those failure(s) now.*

5. Return to foldout.
  - Determine next task by comparing test results to conditions shown in each **FURTHER**.

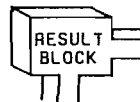

for TEST SUB A12

**A12 MODULE DIAGNOSTICS**

---

**Condition 2**

1. **INSTR PRESET** **SHIFT**  
 (Hold shift key until "100.000000MZ -140.0DM" appears, to override 20 second reset test.)
2. **SHIFT** **SPCL** **3** **3** **4** **5** **HZ**
3. When "WAITING FOR SET-UP 1 .V24" appears:
  - Disconnect cable **W31** from module at **A12A2 J2**.
  - Connect **YELLOW PM** cable and adapter to cable **W31**.
  - **HZ** to continue test.
4. When "WAITING FOR SET-UP 2 .V25" appears:
  - Reconnect cable **W31** to module at **A12A2 J2**.
  - Disconnect cable **W30** from module at **A12A3 J6**.
  - Connect **PM** cable and apapter to **W30**.
  - **HZ** to continue test.
5. When "WAITING FOR SET-UP 3 .V26" appears:
  - Reconnect cable **W30** to module at **A12A3 J6**.
  - Disconnect cable **W32** from module at **A12A3 J3**.
  - Connect **PM** cable to module at **A12A3 J3**.
  - **HZ** to continue test.
6. When "RECONNECT ALL CABLES .V29" appears:
  - Reconnect cable **W32** to module at **A12A3 J3**.
  - **HZ** to continue test.
7. When "DIAG DONE HIT MSSGS .V1" appears:
  - Use **MSSG** to scroll through messages.
  - Record error code(s) displayed for **A12**.
8. Return to foldout:
  - Determine next task by comparing test results to conditions shown in each **RESULT BLOCK** for **TEST SUB A12 FURTHER**.

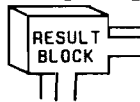

**Condition 3**

1. Set instrument to operating condition which causes **A12 failure**.
2. Record instrument set-up and error message(s).
3. Return to foldout:
  - Determine next task by comparing test results to conditions shown in each **RESULT BLOCK** for **TEST SUB A12 FURTHER**.

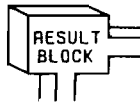

---

**A12 MODULE DIAGNOSTICS**

---

Type:	Module Replacement	A12.14
Run time:	10 sec.	
Set-up time:	5 min.	

**Connect Module**

1. Switch instrument to **Standby**.
2. Disconnect cables **W5**, **W30**, **W31** and **W33** from substitute **A12 Module**.

**CAUTION**

*When connecting ribbon cable, find arrowhead on cable connector and align with arrowhead on board connector.*

3. Reconnect cables **W5**, **W30**, **W31** and **W33** to **A12 Module**.
4. Return substitute **A12 Module** to On-Site Service Kit.

**Down-Load Cal Data****CAUTION**

*Use adequate Electrostatic Discharge Techniques when handling the **A20 Calibration Module**.*

5. After making sure that **A20 Module** for substitute **A12 Module** has been returned to On-Site Service Kit, remove **A20 Calibration Module** from Rear Panel (see **MECHANICAL PROCEDURES** for removal information).

---

**A12 MODULE DIAGNOSTICS**

---

**CAUTION**

*Check that switch S1 on A20 Module is switched up to its "PROTECTED" position.*

6. With instrument switched to **Standby**, connect **A20 Module** to **A3 Module** at **A3J3**.
7. Turn instrument on.
8. When "**100.000000 MZ -140.00 DM**" appears:
  - Slide switch on left side of **A3S2** on **A3 Module** back toward rear of instrument.
9. **SHIFT** **SPCL** **3** **7** **3** **2** **HZ**
10. When "**TRANSFER VERIFIED .U613**" appears:
  - Slide **A3S2** forward toward front of instrument to protect **A3 Module's** memory.
11. Switch Instrument to **Standby** and remove **A20 Module**.  
**Replace A20 Module on Rear Panel.**
12. Return to foldout.

---

**A12 MODULE DIAGNOSTICS**

---

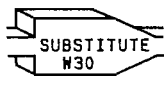
Type:	Cable Connection	<b>A12.15</b>
Run time:	5 min.	
Set-up time:	1 min.	

1. Testing has shown **W30** or **W31** to be suspect, temporarily replace it with a test cable from the On-Site Service Kit. Rerun **INSTRUMENT LEVEL DIAGNOSTICS (ILD)** to confirm repair.
2. Refer to **REPLACEABLE PARTS**, in HP 8642A/B Operating and Service Manual, for information to order a permanent replacement cable.
3. Return to foldout.



---

**A12 MODULE DIAGNOSTICS**

---

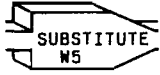
<b>Type:</b>	Cable Substitution	<b>A12.16</b>
<b>Run time:</b>	0 min.	
<b>Set-up time:</b>	3 min.	

Testing has shown cable **W5** to be suspect, temporarily replace with a spare ribbon cable if available. Rerun **INSTRUMENT LEVEL DIAGNOSTICS (ILD)** to confirm repair.

Refer to **REPLACEABLE PARTS**, in HP 8642A/B Operating and Service Manual, for information to order a permanent replacement cable.

**CAUTION**

*When connecting ribbon cable to A12 Module, find arrowhead on the cable plug and align with arrowhead on the board connector.*

**Reconnect W5**

1. Switch instrument to **Standby** to connect cable **W5** to **A5 Assembly** and **A12 Module**. (Refer to table on foldout in **MECHANICAL PROCEDURES** for information on connecting cable **W5** to **A5J5**.)
2. Return to foldout.

---

**A12 MODULE DIAGNOSTICS**

---

Type:	Cable Substitution	A12.17
Run Time:	6 min.	
Set-up Time:	8 min.	

**CAUTION**

*When connecting ribbon cable to A12 Module, find arrowhead on the cable plug and align with arrowhead on the board connector.*

**Reconnect W5**

1. Switch instrument to **Standby** to reconnect cable **W5** to **A5** Assembly or **A12** Module. (Refer to table on foldout in **MECHANICAL PROCEDURES** for information on reconnecting cable **W5** to **A5J5**.)
2. Return to foldout.

---

## A12 THEORY OF OPERATION

---

### 3J-4. A12 SUM LOOP/DIVIDER MODULE

#### COMMENT

*It is not essential to understand the internal operation of a module to make an on-site repair.*

#### Sum Loop

The **A12 Module** contains a phase lock loop which combines the **A9 IF Loop** output (45 to 90 MHz in .5 Hz steps) with the **A11 Reference Loop** output (one of six UHF reference frequencies) to produce the fundamental frequency band of the instrument (528.75 to 1057.5 MHz).

The frequency range of the **Sum Loop** is divided into four bands. Each band is generated by a separate voltage controlled oscillator (VCO).

#### Divider

The **A12 Module** also contains a selectable divider circuit. The **Sum Loop** output passes directly to the RF input of the **Divider**. The **Divider** output (4.1 to 1057.5 MHz) is produced by dividing the fundamental frequency band by 2 raised the N<sup>th</sup> power, where N is an integer between 0 and 7.

See the **A12 MODULE SIMPLIFIED BLOCK DIAGRAM** for further understanding of the **A12 Module's** internal operation.

---

## A13 OUTPUT FILTERS/ALC MODULE

---

### 3K-1. INTRODUCTION

The **MODULE LEVEL DIAGNOSTICS (MLD)** contained in this section are used to further interrogate the **A13 Module**. The objective is to isolate the failure indicated for this module to the module itself or to a part on which it depends for operation.

#### NOTE

*At this level of testing, recommendations for further action are made on the assumption that the **INSTRUMENT LEVEL DIAGNOSTICS (ILD)** showed no failures for modules **A01-A12**. (For information on using the on-site diagnostics, refer to the **INTRODUCTION** section of this manual.)*

#### CAUTION

*When tightening the coax cable connectors, do not exceed a torque of 1.0 Nm or .74 ft-lbs (slightly tighter than finger tight).*

*When coax cables are disconnected from instrument, do not allow loose ends to come in contact with any exposed circuitry susceptible to short circuiting.*

#### Test Instructions

1. The instrument's **Top Cover** must be removed to run many of these tests. (Refer to the table shown on the foldout in **MECHANICAL PROCEDURES** to locate instructions.)
2. The last page in this group of tests is a foldout and should be pulled out now.
3. Turn to the next page to begin the **A13 MLD**.

---

**A13 MODULE SUBSTITUTION**

---

**3K-2. INTRODUCTION****NOTE**

*If a known good module is not available, proceed to the next page A13 INPUTS VERIFICATION.*

The first step in isolating an A13 failure is to substitute in a known good module from the On-site Service Kit.

**A13 Substitution Instructions**

1. Find **A13 MODULE SUBSTITUTION** on the foldout.
2. Use the Task Sequence Diagram, shown under **A13 MODULE SUBSTITUTION**, to direct you through the substitution process. Each Task Arrow shown in a diagram indicates a task title and task number. The tasks are numbered according to the order in which they appear in this section. Turn to the task indicated and complete the procedure.
3. After completing the procedure, return to the Task Sequence Diagram on the foldout and determine the next task to be performed.
4. Begin now by performing the first task shown on the diagram.

**A13 INPUTS VERIFICATION**

---

**A13.01**

**3K-3. INTRODUCTION**

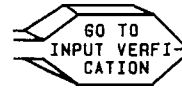

If a known good A13 Module is not available, or if you were not able to isolate the failure using the A13 MODULE SUBSTITUTION procedure, the Task Sequence Diagrams (shown under A13 INPUTS VERIFICATION) should be used to check each signal path into the A13 Module.

A13 Inputs Verification Instructions

1. Find A13 INPUTS VERIFICATION on the foldout.
2. The Task Sequence Diagrams, shown under A13 INPUTS VERIFICATION, are separated into three checks: RF, Control and Power Supply signals.
3. Use the Task Sequence Diagrams to direct you through the verification process. Each Task Arrow shown in a diagram indicates a task title and task number. The tasks are numbered according to the order in which they appear in this section. Turn to the task indicated and complete the procedure.
4. After completing the procedure, return to the Task Sequence Diagram on the foldout and determine the next task to be performed.
5. Begin now by performing the first task shown under **1. A13 RF INPUT CHECK.**

**NOTE**

*The A13 MODULE I/O SIGNALS DIAGRAM shows all parts which the A13 Module depends on for operation.*

**A13 MODULE DIAGNOSTICS**

Type:	1; Loop Lock/Unlock	A13.02
Run time:	30 sec.	
Set-up time:	0	

**Run Test**

1. **INSTR PRESET** **SHIFT**  
 (Hold shift key until "100.000000MZ -140.0DM" appears, to override 20 second reset test.)
2. **SHIFT** **SPCL** **3** **3** **4** **9** **HZ**.
3. When "DIAG DONE HIT MSSG.V1" appears:
  - ⊙ Use **MSSG** to scroll through messages.
  - ⊙ Record error code(s) displayed for **A13**. If "TEST 1 OF A13 (PASSED or FAILED)" is not displayed, rerun test.

**COMMENT**

*If any error codes are displayed for modules A01-A12, you need to isolate those failure(s) before performing the A13 MODULE SUBSTITUTION. (Refer to INSTRUMENT LEVEL DIAGNOSTICS to determine correct order for troubleshooting modules.)*

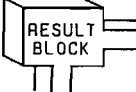
4. Return to foldout:
  - ⊙ Determine next task by comparing test results to conditions shown in each  for **TEST A13 MODULE**.

---

**A13 MODULE DIAGNOSTICS**

---

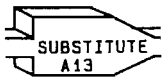
Type:	Module Substitution	<b>A13.03</b>
Run time:	0	
Set-up time:	5 min.	

The following describes the technique for connecting a known good A13 Module without removing the A13 Module in the instrument.

Connect Substitute Module

1. Switch instrument to Standby.
2. Disconnect cables **W6**, **W22**, **W32** and **W34** from **A13** Module (see **A13 MODULE CABLE CONNECTION LOCATOR** on foldout).
3. Without removing **A13** Module from instrument, carefully lay substitute **A13** Module on top of modules **A9**, **A11** and **A12**.

CAUTION

*When connecting ribbon cable, find arrowhead on cable connector and align with arrowhead on board connector.*

4. Connect cables **W6**, **W22**, and **W32** to substitute module.
  5. Substitute a flexible coax cable, SMC-to-SMA adapters, and barrel adapters from On-Site Service Kit for cable **W34**, to connect output of substitute module to **A14** Module.
  6. Turn instrument on.
  7. Return to foldout.
-



---

**A13 MODULE DIAGNOSTICS**

---

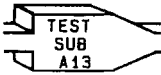
Type:	Substitute Module Test	A13.04
Run time:	1 min.	
Set-up time:	0	

Test operation of substitute A13 Module by repeating test performed on A13 Module before substitution.

### Run Test

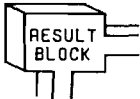
1. **INSTR PRESET** **SHIFT**  
 (Hold shift key until "100.000000MZ -140.0DM" appears, to override 20 second reset test.)
2. **SHIFT** **SPCL** **3** **3** **4** **9** **HZ**.
3. When "DIAG DONE HIT MSSG .V1" appears:
  - Use **MSSG** to scroll through messages.
  - Record error code(s) displayed for A13. If "TEST 1 OF A13 (PASSED OR FAILED)" is not displayed, rerun test.
4. Return to foldout:
  - Determine next task by comparing test results to conditions shown in each  for TEST SUB A13.

**A13 MODULE DIAGNOSTICS**

---

Type:	Additional A13 Tests	<b>A13.05</b>
Run time:	Conditional	
Set-up time:	Conditional	

The **A13** failure conditions for arriving at this task are described below. Follow the procedure for the condition which fits your module.

- Condition 1: Instrument Level Self Test indicated A13 failure.
- Condition 2: A14 Module RF Power Test indicated A13 failure.
- Condition 3: Instrument must be set to a specific operating condition to detect A13 failure.

Condition 1

1.    
 (Hold shift key until "100.000000MZ -140.0DM" appears, to override 20 second reset test.
2.      .
3. When "WAITING FOR SET-UP 1 .V24" appears:
  - Connect BNC Tee connector, from On-Site Service Kit, to "FM/ΦM INPUT" (see INSTRUMENT LEVEL DIAGNOSTICS foldout for set-up diagram).
  - Connect a coax cable from Tee connector to "MOD OUTPUT".
  - Connect a coax cable from Tee to "AM/PULSE INPUT"
4. When "DIAG DONE HIT MSSGS.VI" appears:
  - Use  to scroll through messages.
  - Record **A13** error codes.

**COMMENT**

*If any error codes are displayed for modules A01-A12, you need to isolate those failure(s) before performing the A13 MODULE SUBSTITUTION. (Refer to INSTRUMENT LEVEL DIAGNOSTICS to determine correct order for troubleshooting modules.)*

5. Return to foldout.
-

---

**A13 MODULE DIAGNOSTICS**

---

**Condition 2**

1.    
 (Hold shift key until "100.000000MZ -140.0DM" appears, to override 20 second reset test.)
2.
3. When "WAITING FOR SET-UP 1 .V24" appears:
  - Disconnect cable W32 from module at A13A2 J6.
  - Connect YELLOW PM cable and adapter to cable W32.
  - to continue test.
4. When "WAITING FOR SET-UP 2 .V25" appears:
  - Reconnect cable W32 to module at A13A2 J6.
  - Disconnect cable W34 from module at A13A2 J3.
  - Connect PM cable, SMC-to-SMA adapter, and barrel adapter from On-Site Service Kit to module at A13A2 J3.
  - to continue test.
5. When "RECONNECT ALL CABLES .V29" appears:
  - Reconnect cable W34 to module at A13A2 J3.
  - to continue test.
6. When "DIAG DONE HIT MSSGS .V1" appears:
  - Use  to scroll through messages.
  - Record error code(s) displayed for A13.
7. Return to foldout.

**Condition 3**

1. Set instrument to operating condition which causes A13 failure.
  2. Record instrument set-up and error message(s).
  3. Return to foldout.
-

**A13 MODULE DIAGNOSTICS**

Type:	Additional Substitute A13 Tests	<b>A13.06</b>
Run time:	Conditional	
Set-up time:	Conditional	

Test operation of substitute A13 Module by repeating test(s) performed on A13 Module before substitution.

- Condition 1: Instrument Level Self Test indicated A13 failure.
- Condition 2: A14 Module RF Power Test indicated A13 failure.
- Condition 3: Instrument must be set to a specific operating condition to detect A13 failure.

Condition 1

1.    
 (Hold shift key until "100.000000MZ -140.0DM" appears, to override 20 second reset test.
2.      .
3. When "WAITING FOR SET-UP 1 .V24" appears:
  - Connect BNC Tee connector, from On-Site Service Kit, to "FM/ΦM INPUT" (see INSTRUMENT LEVEL DIAGNOSTICS foldout for set-up diagram).
  - Connect a coax cable from Tee connector to "MOD OUTPUT".
  - Connect a coax cable from Tee to "AM/PULSE INPUT"
4. When "DIAG DONE HIT MSSGS .VI" appears:
  - Use  to scroll through messages.
  - Record A13 error codes.

**COMMENT**

*If any error codes are displayed for modules A01-A12, you need to isolate those failure(s) now.*

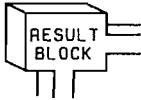
5. Return to foldout.
  - Determine next task by comparing test results to conditions shown in each  for TEST SUB A13 FURTHER.

---

### A13 MODULE DIAGNOSTICS

---

Condition 2

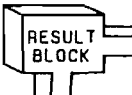
1. **INSTR PRESET** **SHIFT**  
(Hold shift key until "100.000000MZ -140.0DM" appears, to override 20 second reset test.)
2. **SHIFT** **SPCL** **3** **3** **5** **1** **HZ**
3. When "WAITING FOR SET-UP 1 .V24" appears:
  - Disconnect cable W32 from module at A13A2 J6.
  - Connect **YELLOW PM** cable and adapter to cable W32.
  - **HZ** to continue test.
4. When "WAITING FOR SET-UP 2 .V25" appears:
  - Reconnect cable W32 to module at A13A2 J6.
  - Disconnect cable W34 from module at A13A2 J3.
  - Connect **PM** cable and adapters to module at A13A2 J3.
  - **HZ** to continue test.
5. When "RECONNECT ALL CABLES .V29" appears:
  - Reconnect cable W34 to module at A13A2 J3.
  - **HZ** to continue test.
6. When "DIAG DONE HIT MSSGS .V1" appears:
  - Use **MSSG** to scroll through messages.
  - Record error code(s) displayed for A13.
7. Return to foldout:
  - Determine next task by comparing test results to conditions shown in each  for **TEST SUB A13 FURTHER.**

Condition 3

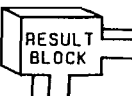
1. Set instrument to operating condition which causes A13 failure.
  2. Record instrument set-up and error message(s).
  3. Return to foldout:
    - Determine next task by comparing test results to conditions shown in each  for **TEST SUB A13 FURTHER.**
-

---

**A13 MODULE DIAGNOSTICS**

---

Type:	Cable Connection	<b>A13.07</b>
Run time:	0	
Set-up time:	5 min.	

**Connect Module**

1. Switch instrument to Standby.
2. Disconnect cables W6, W22, W32 and substitute output cable from substitute A13 Module.

**CAUTION**

*When connecting ribbon cable, find arrowhead on cable connector and align with arrowhead on board connector.*

3. Reconnect cables W6, W22, W32 and W34 to A13 Module.
4. Turn instrument on.
5. Return substitute A13 Module to On-Site Service Kit.
6. Return to foldout.

**A13 MODULE DIAGNOSTICS**

---

Type:	2A; RF Power Levels	A13.08
Run time:	1 min. 30 sec.	
Set-up time:	2 min.	

RF signal level is measured using Internal Power Meter (PM).

CAUTION

*Do not permit end of Internal Power Meter cable to short circuit instrument by coming in contact with any exposed circuitry.*

**Run Test**

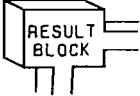
1. **INSTR PRESEN** **SHIFT**  
 (Hold shift key until "100.000000MZ -140.0DM" appears, to override 20 second reset test.)
2. **SHIFT** **SPCL** **3** **6** **8** **1** **2** **HZ**  
 (To check input levels only.)
3. **3** **5** **1** **HZ**.
4. When "WAITING FOR SET-UP 1 .V24" appears:
  - Disconnect cable W32 from module at A13A2 J6.
  - Connect **YELLOW PM** cable and adapter to cable W32.
  - **HZ** to continue test.
5. When "RECONNECT ALL CABLES .V29" appears:
  - Reconnect cable W32 to module at A13A2 J6.
  - **HZ** to continue test.
6. When "DIAG DONE HIT MSSGS .V1" appears:
  - Use **MSSG** to scroll through messages.
  - Record error code(s) displayed for A13.
7. Return to foldout:
  - Determine next task by comparing test results to conditions shown in each  for **TEST RF POWER**.

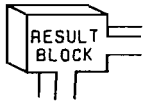

**A13 MODULE DIAGNOSTICS**

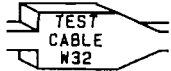
Type:	2A; RF Power Levels	A13.09
Run time:	1 min. 30 sec.	
Set-up time:	2 min.	

RF signal level is measured using Internal Power Meter (PM).

Run Test

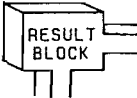
1.    
 Hold shift key until "100.00000MZ -140.0DM" appears, to override 20 second reset test.)
2.          
 (To check input levels only.)
3.
4. When "WAITING FOR SET-UP 1 .V24" appears:
  - Disconnect cable W32 from A12 Module at A12A3 J3. (See Top View Diagram inside Top Cover to locate W32 connection on A12 Module.)
  - Connect YELLOW PM cable to module at A12A3 J3.
  - to continue test.
5. When "RECONNECT ALL CABLES .V29" appears:
  - Reconnect cable W32 to module at A12A3 J3.
  - to continue test.
6. When "DIAG DONE HIT MSSGS .V1" appears:
  - Use  to scroll through messages.
  - Record error code(s) displayed for A13.
7. Return to foldout:
  - Determine next task by comparing test results to conditions shown in each  for TEST CABLE W32.



---

**A13 MODULE DIAGNOSTICS**

---

Type:	3; Bit Transmission	A13.10
Run time:	3 min.	
Set-up time:	2 min.	

Internal Voltmeter (VM) is used to measure TTL level changes transmitted to A13 Module on Clock and Data control lines.

### Run Test

1. Switch instrument to Standby:
  - Disconnect cable W6 from module at A13A2 J1.
  - Plug end of W6 into 16 pin test connector, from On-Site Service Kit.

#### NOTE

*Find arrowhead on test connector and align with arrowhead on cable plug W6P2.*

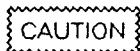

*To prevent damage to the Power Supply and Control sections, do not permit the exposed pins on the test connector to short circuit.*

2. Connect VM probe:
  - Connect red alligator clip and retractable hook probe to red test lead provided in On-Site Service Kit.
  - Connect alligator clip to VM IN (A4TP1). (See A13 MODULE CABLE CONNECTION LOCATOR on fold-out for VM IN location.)
3. Turn instrument on.  
 (Hold shift key until "100.000000MZ -140.0DM" appears, to override 20 second reset test.)

**A13 MODULE DIAGNOSTICS**

---

Clock Line

Check High State

4.        
 (To specify high state.)

**NOTE**

*A "0" will appear in display indicating that the data bit will be set low. However, the bit is inverted in the Control Section before it is sent to A13.*

5.     
 (To select bit.)

6. Connect VM probe to test connector line OS CLK (pin 15).  
 (See Figure 3K-1. Cable plug W6P2 Signal Locator.)

**Figure 3K-1. Cable Plug W6P2 Signal Locator**

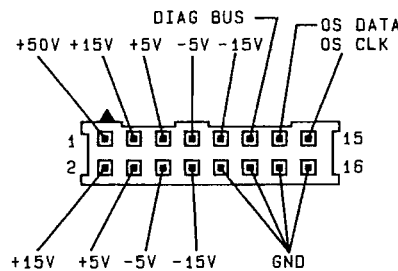

7.     
 (To enable voltmeter.)

8. Voltage should read approximately +2.5 to +5.5 Vdc.  
  to repeat measurement.)

---

**A13 MODULE DIAGNOSTICS**

---

**Check Low State**

9.        
 (To specify low state.)

**NOTE**

*A "1" will appear in display indicating that the data bit will be set high. However, the bit is inverted in the Control Section before it is sent to A13.*

10.     
 (To select bit.)
11.     
 (To enable voltmeter.)
12. Voltage should read approximately  $-0.5$  to  $+1.5$  Vdc.  
  to repeat measurement.)

**Data Line****Check High State**

13.        
 (To specify high state.)
14.     
 (To select bit.)
15. Connect VM probe to test connector line OS DATA (pin 13). (See Figure 3-xx. Cable Plug W6P2 Signal Locator.)
16.     
 (To enable voltmeter.)
17. Voltage should read approximately  $+2.5$  to  $+5.5$  Vdc.  
  to repeat measurement.)
-

---

**A13 MODULE DIAGNOSTICS**

---

**Check Low State**

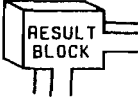
18.  SHIFT  SPCL  3  6  0  1  
(To specify low state.)
19.  4  1  HZ  
(To select bit.)
20.  2  5  HZ  
(To enable voltmeter.)
21. Voltage should read approximately  $-0.5$  to  $+1.5$  Vdc.  
( 5  HZ to repeat measurement.)
22. Record test results.
23. Return to foldout:
  - Determine next task by comparing test results to conditions shown in each  for **TEST CONTROL BITS**.

---

**A13 MODULE DIAGNOSTICS**

---

Type:	3; Bit Transmission	A13.11
Run time:	3 min.	
Set-up time:	3 min.	

Internal Voltmeter (VM) is used to measure TTL level changes transmitted to A13 Module on Clock and Data control lines.

**Run Test**

1. Switch instrument to Standby.
2. Extend A13 Module on extender posts, from On-Site Service Kit, and disconnect cable W6 from A5 Assembly at A5J6. (See table on foldout in MECHANICAL PROCEDURES to locate A13 Module extension and A5 cable disconnection information.)
3. Connect VM probe:
  - Connect red alligator clip and pointed tip probe to red test lead provided in On-Site Service Kit.
  - Connect alligator clip to VM IN (A4TP1). (See A13 MODULE CABLE CONNECTION LOCATOR on foldout for VM IN location.)
4. Turn instrument on.

**Clock Line****Check High State**

5.        
(To specify high state.)
  6.     
(To select bit.)
-

**A13 MODULE DIAGNOSTICS**

7. Connect VM probe to solder-side of A5J6 line OS CLK (pin 2). (See Figure 3K-2. A5J6 Signal Locator.)

**Figure 3K-2. A5J6 Signal Locator**  
(Solder-Side View)

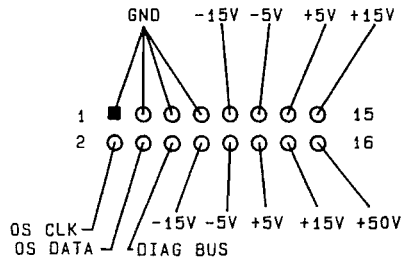

8.     
(To enable voltmeter.)
9. Voltage should read approximately +2.5 to +3.5 Vdc.  
  to repeat measurement.)

**Check Low State**

10.        
(To specify low state.)
11.     
(To select bit.)
12.     
(To enable voltmeter.)
13. Voltage should read approximately -0.5 to +1.5 Vdc.  
  to repeat measurement.)

**Data Line**

**Check High State**

14.        
(To specify high state.)
15.     
(To select bit.)

---

**A13 MODULE DIAGNOSTICS**

---

16. Connect VM probe to solder-side of A5J6 line OS DATA (pin 4). (See Figure 3K-2. A5J6 Signal Locator.)
17. **2** **5** **HZ**  
(To enable voltmeter.)
18. Voltage should read approximately +2.5 to +5.5 Vdc.  
(**5** **HZ** to repeat measurement.)

**Check Low State**

19. **SHIFT** **SPCL** **3** **6** **0** **1**  
(To specify low state.)
20. **4** **1** **HZ**  
(To select bit.)
21. **2** **5** **HZ**  
(To enable voltmeter.)
22. Voltage should read approximately -0.5 to +1.5 Vdc.  
(**5** **HZ** to repeat measurement.)
23. Record test results.
24. Return to foldout:
  - Determine next task by comparing test results to conditions shown in each CTL LINES.

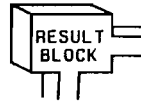

for TEST CABLE W6

**A13 MODULE DIAGNOSTICS**

---

Type:	4, Voltage Measurements	A13.12
Run time:	2 min.	
Set-up time:	2 min.	

Internal Voltmeter (VM) is used to check power supply levels at inputs to A13 Module.

**Run Test**

1. Switch instrument to Standby:
  - Disconnect W6 from A13 at A13A2 J1.
  - Plug end of W6 into 16 pin test connector, from On-Site Service Kit.

**NOTE**

*Find arrowhead on test connector and align with arrowhead on cable plug W6P2.*

2. Connect VM probe:
  - Connect red alligator clip and retractable hook probe to red test lead provided in On-Site Service Kit.
  - Connect alligator clip to VM IN (A4TP1). (See A13 MODULE CABLE CONNECTION LOCATOR on fold-out for VM IN location.)

3. Turn instrument on and enter:
 

SHIFT	SPCL	3	2	5	HZ
-------	------	---	---	---	----

 (To enable Internal Voltmeter.)



**A13 MODULE DIAGNOSTICS**

---

4. Measure voltage levels:
  - Connect VM probe to test connector pin for each power supply line (see Figure 3K-3. Cable Plug W6P2 Signal Locator).
  - **5** **HZ** (To make each voltage measurement.)

Figure 3K-3. Cable Plug W6P2 Signal Locator

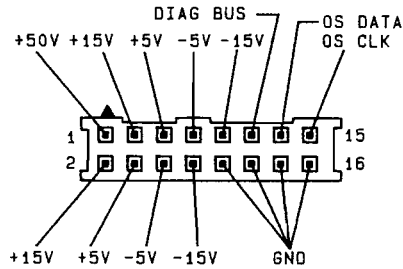

5. Record test results.
6. Return to foldout:
  - Determine next task by comparing test results to conditions shown in each **RESULT BLOCK** for TEST Vdc.

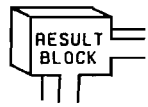

---

**A13 MODULE DIAGNOSTICS**

---

Type:	4, Voltage Measurements	<b>A13.13</b>
Run time:	2 min.	
Set-up time:	3 min.	

Internal Voltmeter (VM) is used to check power supply levels at **A5J6**.

Run Test

1. Switch instrument to Standby.
2. Extend **A13 Module** on extender posts, from On-Site Service Kit or instrument, and disconnect cable **W6** from **A5 Assembly** at **A5J6**. (See table on foldout in **MECHANICAL PROCEDURES** to locate **A13 Module** extension and **A5** cable disconnection information.)
3. Connect VM probe:
  - Connect red alligator clip and pointed tip probe to red test lead provided in On-Site Service Kit.
  - Connect alligator clip to **VM IN (A4TP1)**. (See **A13 MODULE CABLE CONNECTION LOCATOR** on fold-out for **VM IN** location.)
4. Turn instrument on and enter:  
       
 (To enable Internal Voltmeter.)

**A13 MODULE DIAGNOSTICS**

5. Measure voltage levels at A5J6:
  - Access signals from solder-side of A5J6. (See Figure 3K-4, A5J6 Signal Locator.)
  - (To make each voltage measurement.)

Figure 3K-4. A5J6 Signal Locator (Solder-Side View)

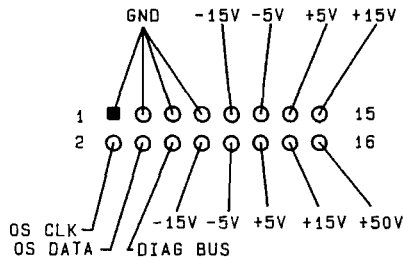

6. Record test results.
7. Return to folout:
  - Determine next task by comparing test results to conditions shown in each PS LINES.

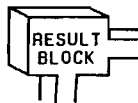

for TEST CABLE W6

---

**A13 MODULE DIAGNOSTICS**

---

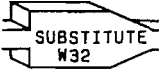
Type:	Cable Substitution	A13.14
Run Time:	5 min.	
Set-up Time:	1 min.	

1. Testing has shown cable **W32** to be suspect, temporarily replace with a test cable from the On-Site Service Kit. Rerun **INSTRUMENT LEVEL DIAGNOSTICS (ILD)** to confirm repair.
2. Refer to **REPLACEABLE PARTS**, in HP 8642A/B Operating and Service Manual, for information to order a permanent replacement cable.
3. Return to foldout.

---

**A13 MODULE DIAGNOSTICS**

---

Type:	Cable Substitution	A13.15
Run time:	0 min.	
Set-up time:	3 min.	

Testing has shown cable **W6** to be suspect, temporarily replace with a spare ribbon cable if available. Rerun **INSTRUMENT LEVEL DIAGNOSTICS (ILD)** to confirm repair.

Refer to **REPLACEABLE PARTS**, in HP 8642A/B Operating and Service Manual, for information to order a permanent replacement cable.

CAUTION

*When connecting ribbon cable to A13 Module, find arrowhead on the cable plug and align with arrowhead on the board connector.*

**Reconnect W6**

1. Switch instrument to **Standby** to connect cable **W6** to **A5** Assembly and **A13** Module. (Refer to table on foldout in **MECHANICAL PROCEDURES** for information on connecting cable **W6** to **A5J6**.)
  2. Return to foldout.
-

---

**A13 MODULE DIAGNOSTICS**

---

<b>Type:</b>	Cable Connection	<b>A13.16</b>
<b>Run time:</b>	0 min.	
<b>Set-up time:</b>	3 min.	

**CAUTION**

*When connecting ribbon cable to A13 Module, find arrowhead on the cable plug and align with arrowhead on the board connector.*

**Reconnect W6**

1. Switch instrument to Standby to reconnect cable **W6** to **A5** Assembly or **A13** Module. (Refer to table on foldout in **MECHANICAL PROCEDURES** for information on reconnecting cable **W6** to **A5J6**.)
2. Return to foldout.

---

**A13 THEORY OF OPERATION**

---

**3K-4. A13 OUTPUT FILTERS/ALC MODULE****COMMENT**

*It is not essential to understand the internal operation of a module to make an on-site repair.*

The **A13 Module** contains an Automatic Level Control (ALC) circuit. The ALC loop adjusts the level of the RF signal to between **+5** and **+21.5 dBm** in **0.1 dB** steps. An audio signal, sent from the **A2 Module**, is applied to the ALC loop's feedback path to provide amplitude and pulse modulation for all output, frequency bands, (except the Doubler Band in the HP 8642B.)

An array of selectable, low-pass filters in the RF signal path filters the harmonics produced by the divider in the **A12 Module**.

See the **A13 MODULE SIMPLIFIED BLOCK DIAGRAM** for further understanding of the **A13 Module's** internal operation.

---

**A14 HETERODYNE MODULE**

---

**3L-1. INTRODUCTION**

The **MODULE LEVEL DIAGNOSTICS (MLD)** contained in this section are used to further interrogate the **A14 Module**. The objective is to isolate the failure indicated for this module to the module itself or to a part on which it depends for operation.

**NOTE**

*At this level of testing, recommendations for further action are made on the assumption that the **INSTRUMENT LEVEL DIAGNOSTICS (ILD)** showed no failures for modules **A01-A04** and **A07-A13**. (For information on using the on-site diagnostics, refer to the **INTRODUCTION** section of this manual.)*

**CAUTION**

*When tightening the coax cable connectors, do not exceed a torque of 1.0 Nm or .74 ft-lbs (slightly tighter than finger tight).*

*When coax cables are disconnected from instrument, do not allow loose ends to come in contact with any exposed circuitry susceptible to short circuiting.*

**Test Instructions**

1. The instrument's **Top Cover** must be removed to run many of these tests. (Refer to table on foldout in **MECHANICAL PROCEDURES** to locate instructions.)
2. The last page in this group of tests is a foldout and should be pulled out now.
3. If you have been directed here to troubleshoot an **RF power level** failure, turn to page **3-4** to begin diagnostics, otherwise, proceed to the next page to begin the **A14 MLD**.



---

**A14 MODULE SUBSTITUTION**

---

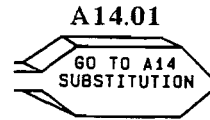
**3L-2. INTRODUCTION****NOTE**

*If a known good module is not available, proceed to the next page A14 INPUTS VERIFICATION.*

**A14 Substitution Instructions**

1. Find **A14 MODULE SUBSTITUTION** on the foldout.
2. Use the Task Sequence Diagram, shown under **A14 MODULE SUBSTITUTION**, to direct you through the substitution process. Each Task Arrow shown in the diagram indicates a task title and task number. The tasks are numbered according to the order in which they are arranged in this section. Turn to the task indicated and complete the procedure.
3. After completing the procedure, return to the Task Sequence Diagram on the foldout and determine the next task to be performed.
4. Begin now by performing the first task shown on the diagram.

---

**A14 INPUTS VERIFICATION**

---

**A14.02****3L-3. INTRODUCTION**

If a known good **A14 Module** is not available, or if you were not able to isolate the failure using the **A14 MODULE SUBSTITUTION** procedure, the Task Sequence Diagrams (shown under **A14 INPUTS VERIFICATION**) should be used to check each signal path into the **A14 Module**.

**A14 Inputs Verification Instructions**

1. Find **A14 INPUTS VERIFICATION** on the foldout.
2. The Task Sequence Diagrams, shown under **A14 INPUTS VERIFICATION**, are separated into three checks: **RF**, **Control** and **Power Supply** signals.
3. Use the Task Sequence Diagrams to direct you through the verification process. Each Task Arrow shown in a diagram indicates a task title and task number. The tasks are numbered according to the order in which they are arranged in this section. Turn to the page indicated and complete the procedure.
4. After completing the procedure, return to the Task Sequence Diagram on the foldout and determine the next task to be performed.
5. Begin now by performing the first task shown under **1. A14 RF INPUT CHECK**.

**NOTE**

*The **A14 MODULE I/O SIGNALS DIAGRAM** shows all parts which the **A14 Module** depends on for operation.*

## POWER LEVEL DIAGNOSTICS

---

### 3L-4. INTRODUCTION

The first step in isolating an RF power level failure is to check the power levels into and out of the A14 Module.

#### Power Diagnostics Instructions

1. Find **POWER LEVEL DIAGNOSTICS** on the foldout.
  2. Use the Task Sequence Diagram, shown under **POWER LEVEL DIAGNOSTICS**, to direct you through the testing process. Each Task Arrow shown in the diagram indicates a task title and task number. The tasks are numbered according to the order in which they are arranged in this section. Turn to the page indicated and complete the procedure.
  3. After completing the procedure, return to the Task Sequence Diagram on the foldout and determine the next task to be performed.
  4. Begin now by performing the first task shown on the diagram.
-

---

**A14 MODULE DIAGNOSTICS**

---

Type:	2A; RF Power Levels	A14.03
Run time:	1 min. 35 sec.	
Set-up time:	3 min.	

RF signal levels are measured using Internal Power Meter (PM).

**CAUTION**

*Do not permit end of Internal Power Meter cable to short circuit instrument by coming in contact with any exposed circuitry.*

**Run Test**

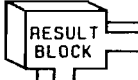
1. **[INSTR PRESET] [SHIFT]**  
(Hold shift key until "100.000000MZ -140.0DM" appears, to override 20 second reset test.)
  2. **[SHIFT] [SPCL] [3] [3] [5] [6] [HZ]**
  3. When "WAITING FOR SET-UP 1 .V24" appears:
    - Disconnect cable W29 from A14 Module at A14A2 J1.
    - Connect **YELLOW** PM cable and adapter to cable W29.
    - **[HZ]** to continue test.
  4. When "WAITING FOR SET-UP 2 .V25" appears:
    - Reconnect cable W29 to module at A14A2 J1.
    - Disconnect cable W34 from A13 Module at A13A2 J3.
    - Connect **PM** cable to A13 Module at A13A2 J3 using adapter and barrel adapter from On-Site Service Kit.
    - **[HZ]** to continue test.
  5. When "WAITING FOR SET-UP 3 .V26" appears:
    - Reconnect cable W34 to A13 Module at A13A2 J3.
    - Disconnect cable W36 from A14 Module at A14U1 J3.
    - Connect **PM** cable to A14 Module at A14U1 J3.
    - **[HZ]** to continue test.
  6. When "RECONNECT ALL CABLES .V29" appears:
    - Reconnect cable W36 to module at A14U1 J3.
    - **[HZ]** to continue test.
  7. When "DIAG DONE HIT MSSGS .V1" appears:
    - Use **[MSSG]** to scroll through messages.
    - Record error code(s) displayed for A14.
  8. Return to foldout:
    - Determine next task by comparing test results to conditions shown in each  for **TEST POWER LEVELS**.
-

**A14 MODULE DIAGNOSTICS**

Type:	2A; RF Power Levels	
Run time:	1 min. 35 sec.	
Set-up time:	3 min.	

Cable **W34** is tested by substituting in a test cable from the On-Site Service Kit.

**Run Test**

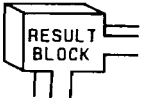
1.    
 (Hold shift key until "100.000000MZ -140.0DM" appears, to override 20 second reset test.)
2.
3. When "WAITING FOR SET-UP 1 .V24" appears:
  - Disconnect cable **W29** from **A14** Module at **A14A2 J1**.
  - Connect **YELLOW PM** cable and adapter to cable **W29**.
  - to continue test.
4. When "WAITING FOR SET-UP 2 .V25" appears:
  - Reconnect cable **W29** to module at **A14A2 J1**.
  - Disconnect cable **W34** from **A13** and **A14** modules at **A13A2 J3** and **A14U1 J3**.
  - Connect **PM** cable to **A13** Module at **A13A2 J3** using adapter and barrel adapter from On-Site Service Kit.
  - to continue test.
5. When "WAITING FOR SET-UP 3 .V26" appears:
  - Connect test cable (flexible) to **A13** and **A14** modules at **A13A2 J3** and **A14U1 J3**.
  - Disconnect cable **W36** from **A14** Module at **A14U1 J3**.
  - Connect **PM** cable to **A14** Module at **A14U1 J3**.
  - to continue test.
6. When "RECONNECT ALL CABLES .V29" appears:
  - Reconnect cable **W36** to module at **A14U1 J3**.
  - to continue test.
7. When "DIAG DONE HIT MSSGS .V1" appears:
  - Use  to scroll through messages.
  - Record error code(s) displayed for **A14**.
8. Return to foldout:
  - Determine next task by comparing test results to conditions shown in each  for **TEST CABLE W34**.

**A14 MODULE DIAGNOSTICS**

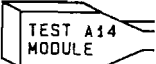
Type:	1; Loop Lock/Unlock	<b>A14.05</b> 
Run time:	1 min.	
Set-up time:	0	

**Run Test**

1.    
 (Hold shift key until "100.000000MZ -140.0DM" appears, to override 20 second reset test.)
2.       .
3. When "DIAG DONE HIT MSSG .V1" appears:
  - Use  to scroll through messages.
  - Record error code(s) displayed for A6. If "TEST 1 OF A06 (PASSED OR FAILED)" is not displayed, rerun test.

**NOTE**

The A14 Module's loop test is included in this A6 Module test.

**COMMENT**

If any error codes are displayed for modules A01-A04 or A07-A13, you need to isolate those failure(s) before performing the A14 MODULE SUBSTITUTION. (Refer to INSTRUMENT LEVEL DIAGNOSTICS to determine correct order for troubleshooting modules.)

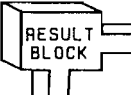
4. Return to foldout:
  - Determine next task by comparing test results to conditions shown in each  for TEST A14 MODULE.

---

**A14 MODULE DIAGNOSTICS**

---

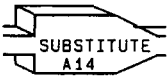
<b>Type:</b>	Module Substitution	<b>A14.06</b>
<b>Run time:</b>	0	
<b>Set-up time:</b>	5 min.	

The following describes the technique for connecting a known good A14 Module.

**Connect Substitute Module**

1. Switch instrument to **Standby**.
2. Extend **A14 Module**. (Refer to table on foldout in **MECHANICAL PROCEDURES** to locate extension information.)
3. Disconnect cables **W7**, **W29**, **W34** and **W36** from **A14 Module** (see **A14 MODULE CABLE CONNECTION LOCATOR** on foldout).
4. Without removing **A14 Module** from instrument, carefully lay substitute **A14 Module** on top of modules **A9**, **A11** and **A12**.

**CAUTION**

*When connecting ribbon cable, find arrowhead on cable connector and align with arrowhead on board connector.*

5. Connect cables **W7** and **W29** to substitute module.
  - ◆ Use SMA-to-SMC adapters, SMA barrel adapters and flexible coax cable from On-Site Service Kit in place of cable **W34** to connect substitute **A14** to output of **A13 Module**.

**NOTE**

*A14 Module output need not be connected to run test.*

6. Turn instrument on.
  7. Return to foldout.
-

---

### A14 MODULE DIAGNOSTICS

---

<b>Type:</b> <b>Run time:</b> <b>Set-up time:</b>	Substitute Module Test 1 min. 0	<b>A14.07</b> 
---	---------------------------------------	---

This procedure tests operation of substitute A14 Module by repeating test performed on A14 Module before substitution.

#### Run Test

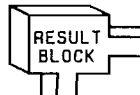
1.    
 (Hold shift key until "100.000000MZ -140.0DM" appears, to override 20 second reset test.)
2.       .
3. When "DIAG DONE HIT MSSG .V1" appears:
  - Use  to scroll through messages.
  - Record error code(s) displayed for A6. If "TEST 1 OF A06 (PASSED OR FAILED)" is not displayed, rerun test.
4. Return to foldout:
  - Determine next task by comparing test results to conditions shown in each  for TEST SUB A14.

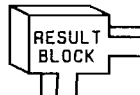



---

**A14 MODULE DIAGNOSTICS**

---

<b>Type:</b>	Additional A14 Tests	<b>A14.08</b>
<b>Run time:</b>	Conditional	
<b>Set-up time:</b>	Conditional	

The **A14** failure conditions for arriving at this task are described below. Follow the procedure for the **condition** which fits your module.

- Condition 1:** Instrument Level Self Test indicated **A14** failure.
- Condition 2:** **A14** Module failed **POWER LEVEL DIAGNOSTICS**.
- Condition 3:** Instrument must be set to a specific operating condition to detect **A14** failure.

Condition 1

1.    
(Hold shift key until "100.000000MZ -140.0DM" appears, to override 20 second reset test.
2.      .
3. When "WAITING FOR SET-UP 1 .V24" appears:
  - Connect BNC Tee connector, from On-Site Service Kit, to "FM/ΦM INPUT" (see **INSTRUMENT LEVEL DIAGNOSTICS** foldout for set-up diagram).
  - Connect a coax cable from Tee connector to "MOD OUTPUT".
  - Connect a coax cable from Tee to "AM/PULSE INPUT"
4. When "DIAG DONE HIT MSSGS .VI" appears:
  - Use  to scroll through messages.
  - Record any **A06** and **A14** error codes.

**COMMENT**

*If any error codes are displayed for modules A01-A04 or A07-A13, you need to isolate those failure(s) before performing the A14 MODULE SUBSTITUTION. (Refer to INSTRUMENT LEVEL DIAGNOSTICS to determine correct order for troubleshooting modules.)*

5. Return to foldout.
-

---

**A14 MODULE DIAGNOSTICS**

---

**Condition 2**

1. Use results from **TEST RF POWER** to check substitute module.
2. Rerun test now if necessary to ensure all test results have been recorded accurately.
3. Return to foldout.

**Condition 3**

1. Set instrument to operating condition which causes **A14 failure**.
2. Record instrument set-up and error message(s).
3. Return to foldout.

**A14 MODULE DIAGNOSTICS**

Type:	Additional Substitute A14 Tests	A14.09
Run time:	Conditional	
Set-up time:	Conditional	

This procedure tests operation of substitute A14 Module by repeating test(s) performed on A14 Module before substitution.

- Condition 1: Instrument Level Self Test indicated A14 failure.
- Condition 2: A14 Module failed POWER LEVEL DIAGNOSTICS.
- Condition 3: Instrument must be set to a specific operating condition to detect A14 failure.

**Condition 1**

1. **INSTR PRESET** **SHIFT**  
(Hold shift key until "100.000000MZ -140.0DM" appears, to override 20 second reset test.
2. **SHIFT** **SPCL** **3** **3** **0** **HZ**.
3. When "WAITING FOR SET-UP 1 V24" appears:
  - Connect BNC Tee connector, from On-Site Service Kit, to "FM/ΦM INPUT" (see INSTRUMENT LEVEL DIAGNOSTICS foldout for set-up diagram).
  - Connect a coax cable from Tee connector to "MOD OUTPUT".
  - Connect a coax cable from Tee to "AM/PULSE INPUT"
4. When "DIAG DONE HIT MSSGS.VI" appears:
  - Use **MSSG** to scroll through messages.
  - Record A6 or A14 error codes.

**COMMENT**

*If any error codes are displayed for modules A01-A04 or A07-A13, you need to isolate those failure(s) now.*

5. Return to foldout.
  - Determine next task by comparing test results to conditions shown in each **FURTHER**.

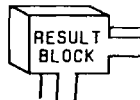

for TEST SUB A14

---

**A14 MODULE DIAGNOSTICS**

---

**Condition 2**

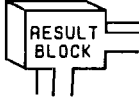
1. Use results from **A14.03** to check substitute module.
2. Rerun test now if necessary to ensure all test results have been recorded accurately.
3. Return to foldout:
  - Determine next task by comparing test results to conditions shown in each  for **TEST SUB A14 FURTHER.**

**Condition 3**

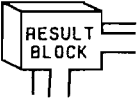
1. Set instrument to operating condition which causes **A14** failure.
2. Record instrument set-up and error message(s).
3. Return to foldout:
  - Determine next task by comparing test results to conditions shown in each  for **TEST SUB A14 FURTHER.**

---

**A14 MODULE DIAGNOSTICS**

---

Type:	Cable Connection	<b>A14.10</b>
Run time:	0	
Set-up time:	5 min.	

**Connect Module**

1. Switch instrument to **Standby**.
2. Disconnect cables **W7, W29, W34** and **W36** from substitute **A14 Module**.
3. Return substitute A14 Module to On-Site Service Kit.

**CAUTION**

*When connecting ribbon cable, find arrowhead on cable connector and align with arrowhead on board connector.*

4. Reconnect **W7** to module at **A14A3 J6** and lower module back into instrument.
5. Reconnect cables **W7, W29, W34** and **W36** to **A14 Module**.
6. Turn instrument on.
7. Return to foldout.

**A14 MODULE DIAGNOSTICS**

Type:	2A; RF Power Levels	A14.11
Run time:	1 min.	
Set-up time:	2 min.	

RF signal level is measured using Internal Power Meter (PM).

**CAUTION**

*Do not permit end of Internal Power Meter cable to short circuit instrument by coming in contact with any exposed circuitry.*

**Run Test**

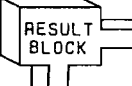
1. **[INSTR PRESET] [SHIFT]**  
(Hold shift key until "100.000000MZ -140.0DM" appears, to override 20 second reset test.)
2. **[SHIFT] [SPCL] [3] [6] [8] [1] [3] [HZ]**  
(To check input levels only.)
3. **[3] [5] [6] [HZ]**.
4. When "WAITING FOR SET-UP 1 .V24" appears:
  - Disconnect cable W29 from module at A14A2 J1.
  - Connect YELLOW PM cable and adapter to cable W29.
  - **[HZ]** to continue test.
5. When "WAITING FOR SET-UP 2 .V25" appears:
  - Reconnect cable W29 to module at A14A2 J1.
  - Disconnect cable W34 from A13 Module at A13A2 J3.
  - Connect PM cable to A13 Module at A13A2 J3 using adapter and barrel adapter from On-Site Service Kit.
  - **[HZ]** to continue test.
6. When "RECONNECT ALL CABLES .V29" appears:
  - Reconnect cable W34 to module at A13A2 J3.
  - **[HZ]** to continue test.
7. When "DIAG DONE HIT MSSGS .V1" appears:
  - Use **[MSSG]** to scroll through messages.
  - Record error code(s) displayed for A14.
8. Return to foldout:
  - Determine next task by comparing test results to conditions shown in each  for TEST RF POWER.

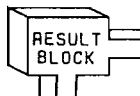

---

**A14 MODULE DIAGNOSTICS**

---

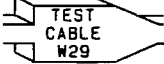
Type:	2A; RF Power Levels	<b>A14.12</b>
Run time:	10 sec.	
Set-up time:	1 min.	

RF signal level is measured using Internal Power Meter (PM).

**Run Test**

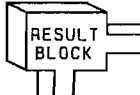
1. **INSTR PRESET** **SHIFT**  
Hold shift key until "100.000000MZ -140.0DM" appears, to override 20 second reset test.)
2. **SHIFT** **SPCL** **3** **6** **8** **1** **2** **HZ**  
(To check input levels only.)
3. **3** **5** **6** **HZ**
4. When "WAITING FOR SET-UP 1 .V24" appears:
  - Disconnect cable W29 from A6 module at A6A2 J9. (See Top View Diagram inside Top Cover to locate W29 connection on A6 Module.)
  - Connect **YELLOW PM** cable and adapter to A6 module at A6A2 J9.
  - **HZ** to continue test.
5. When "RECONNECT ALL CABLES .V29" appears:
  - Reconnect cable W29 to A6 module at A6A2 J9.
  - **HZ** to continue test.
6. When "DIAG DONE HIT MSSGS .V1" appears:
  - Use **MSSG** to scroll through messages.
  - Record error code(s) displayed for A14.
7. Return to foldout:
  - Determine next task by comparing test results to conditions shown in each  for **TEST CABLE W29**.

---

### A14 MODULE DIAGNOSTICS

---

<b>Type:</b> <b>Run time:</b> <b>Set-up time:</b>	3; Bit Transmission 3 min. 2 min.	<b>A14.13</b> 
---	---	---

Internal Voltmeter (VM) is used to measure TTL level changes transmitted to **A14 Module** on MUX and Band select lines.

#### Run Test

1. Switch instrument to Standby:
  - Disconnect cable **W7** from module at **A14A2 J2**.
  - Plug end of **W7** into **16 pin** test connector, from On-Site Service Kit.

#### NOTE

*Find arrowhead on test connector and align with arrowhead on cable plug **W7P2**.*



*To prevent damage to the Power Supply and Control sections, do not permit the exposed pins on the test connector to short circuit.*

2. Connect VM probe:
  - Connect red alligator clip and retractable hook probe to red test lead provided in On-Site Service Kit.
  - Connect alligator clip to **VM IN (A4TP1)**. (See **A14 MODULE CABLE CONNECTION LOCATOR** on fold-out for **VM IN** location.)
3. Turn instrument on.  
 (Hold shift key until "**100.00000MZ -140.0DM**" appears, to override 20 second reset test.)



**A14 MODULE DIAGNOSTICS**

**MUX and Band Select Lines**

**Check High State**

4.        
(To specify high state.)
5. Enter **Bit Select Keys** as indicated in Table 3L-1. **W7P2 Control Bits**, for Control Line to be tested.
6. Connect VM probe to **Control Line** at **Pin Number** indicated in Table 3L-1. (See Figure 3L-1. Cable Plug W7P2 Signal Locator.)

**Table 3L-1. W7P2 Control Bits**

Test Order	Control Line	Bit Select Keys (Steps 5 and 10)	Pin Number (Step 6)
1	MUX A	<input type="button" value="9"/> <input type="button" value="HZ"/>	13
2	MUX B	<input type="button" value="1"/> <input type="button" value="1"/> <input type="button" value="HZ"/>	12
3	HET BAND	<input type="button" value="2"/> <input type="button" value="6"/> <input type="button" value="HZ"/>	15

**Figure 3L-1. Cable Plug W7P2 Signal Locator**

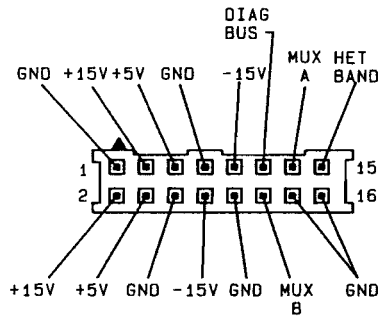

---

**A14 MODULE DIAGNOSTICS**

---

7.     
(To enable voltmeter.)
8. Voltage should read approximately +2.5 to +5.5 Vdc.  
(  to repeat measurement.)

**Check Low State**

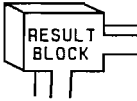
9.        
(To specify low state.)
10. Enter **Bit Select Keys** as indicated in Table 3L-1. **W7P2 Control Bits**, for same **Control Line**.
11.     
(To enable voltmeter.)
12. Voltage should read approximately -0.5 to +1.5 Vdc.  
(  to repeat measurement.)
13. Repeat Procedure for each **Control Line** shown in Table 3L-1.
14. Record test results.
15. Return to foldout:
  - Determine next task by comparing test results to conditions shown in each  for **TEST CONTROL BITS**.

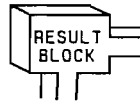

**A14 MODULE DIAGNOSTICS**

---

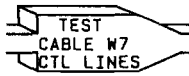
Type:	3; Bit Transmission	<b>A14.14</b>
Run time:	3 min.	
Set-up time:	3 min.	

Internal Voltmeter (VM) is used to measure TTL level changes transmitted to **A14 Module** on MUX and Band select lines.

**Run Test**

1. Switch instrument to **Standby**.
2. Extend **A14 Module** on extender posts, from On-Site Service Kit or instrument, and disconnect cable **W7** from **A5 Assembly** at **A5J7**. (See table on foldout in **MECHANICAL PROCEDURES** to locate **A14 Module** extension and **A5** cable disconnection information.)
3. Connect **VM** probe:
  - Connect red alligator clip and pointed tip probe to red test lead provided in On-Site Service Kit.
  - Connect alligator clip to **VM IN (A4TP1)**. (See **A14 MODULE CABLE CONNECTION LOCATOR** on fold-out for **VM IN** location.)
4. Turn instrument on.

**NOTE**

*It is only necessary to perform this test on failing control line.*

**MUX and Band Select Lines**

**Check High State**

5.  SHIFT  SPCL  3  6  0  1  
(To specify high state.)
6. Enter **Bit Select Keys** as indicated in **Table 3L-2. A5J7 Control Bits**, for **Control Line** to be tested.

**A14 MODULE DIAGNOSTICS**

7. Connect VM probe to Control Line at Pin Number indicated in Table 3L-2. (See Figure 3L-2. A5J7 Signal Locator.)

**Table 3L-2. A5J7 Control Bits**

Test Order	Control Line	Bit Select Keys (Steps 6 and 11)	Pin Number (Step 7)
1	MUX A	[9] [HZ]	14
2	MUX B	[1] [1] [HZ]	15
3	HET BAND	[2] [6] [HZ]	12

**Figure 3L-2. A5J7 Signal Locator  
(Solder-Side View)**

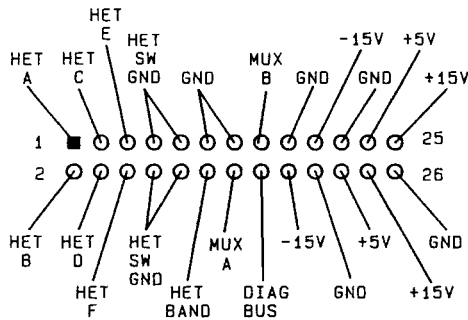

8. [2] [5] [HZ]  
(To enable voltmeter.)
9. Voltage should read approximately +2.5 to +5.5 Vdc.  
([5] [HZ] to repeat measurement.)

---

**A14 MODULE DIAGNOSTICS**

---

**Check Low State**

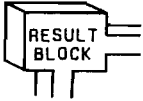
10. **SHIFT** **SPCL** **3** **6** **0** **2**  
(To specify low state.)
11. Enter **Bit Select Keys** as indicated in **Table 3L-2. A5J7**  
**Control Bits**, for same **Control Line**.
12. **2** **5** **HZ**  
(To enable voltmeter.)
13. Voltage should read approximately **-0.5** to **+1.5 Vdc**.  
(**5** **HZ** to repeat measurement.)
14. Record test results.
15. Return to foldout:
  - Determine next task by comparing test results to conditions shown in each  for **TEST CABLE W7**  
**CTL LINES**.

---

**A14 MODULE DIAGNOSTICS**

---

Type:	Driver Transmission	<b>A14.15</b>
Run time:	3 min.	
Set-up time:	4 min.	

Internal Voltmeter (VM) is used to measure level changes transmitted to A14 Module on Switch Driver control lines.

**Run Test**

- Switch instrument to Standby:
  - A14 Module will have to be extended to access A14A3 J6. (See table on foldout in MECHANICAL PROCEDURES to locate module extension instructions.)
  - Disconnect cable W7 from module at A14A3 J6.
  - Plug end of W7 into 10 pin test connector, from On-Site Service Kit.

**NOTE**

*Find arrowhead on test connector and align with arrowhead on cable plug W7P3.*



*To prevent damage to the Power Supply and Control sections, do not permit the exposed pins on the test connector to short circuit.*

- Connect VM probe:
  - Connect red alligator clip and retractable hook probe to red test lead provided in On-Site Service Kit.
  - Connect alligator clip to VM IN (A4TP1). (See A14 MODULE CABLE CONNECTION LOCATOR on foldout for VM IN location.)
- Turn instrument on.  
(Hold shift key until "100.00000MZ -140.0DM" appears, to override 20 second reset test.)

---

**A14 MODULE DIAGNOSTICS**

---

**Check High State**

4.        
 (To specify high state.)

**NOTE**

*A "0" will appear in display indicating that the data bit will be set low. However, the bit is inverted before it is sent to A14.*

5.     
 (To select bits.)

6. Connect VM probe to test connector **HET A** (pin 1). (See Figure 3L-3. Cable plug W7P3 Signal Locator.)

**Figure 3L-3. Cable Plug W7P3 Signal Locator**

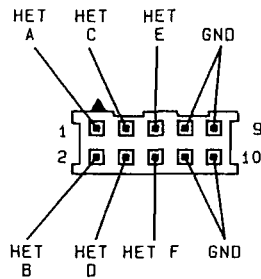

7.     
 (To enable voltmeter.)
8. Voltage should read approximately **+20 Vdc**.
9. Check each driver line (pins **1-6**), by connecting VM probe to each pin and keying  . Voltage should read approximately **+20 Vdc** on each line.
-

---

**A14 MODULE DIAGNOSTICS**

---

**Check Low State**

10. **SHIFT** **SPCL** **3** **6** **0** **1**  
 (To specify low state.)

**NOTE**

*A "1" will appear in display indicating that the data bit will be set high. However, the bit is inverted before it is sent to A14.*

11. **7** **1** **HZ**  
 (To select bits.)
12. **2** **5** **HZ**  
 (To enable voltmeter.)
13. Voltage should read approximately **0 Vdc**.  
 (**5** **HZ** to repeat measurement.)
14. Check each driver line by connecting **VM** probe to each pin and keying **5** **HZ**. Voltage should read approximately **0 Vdc** on each line.
15. Record test results.
16. Return to foldout:  
 • Determine next task by comparing test results to conditions shown in each **RESULT BLOCK** for **TEST SWITCH DRIVE**.

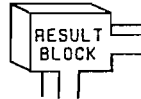



---

**A14 MODULE DIAGNOSTICS**

---

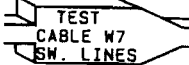
<b>Type:</b>	Driver Transmission	<b>A14.16</b>
<b>Run time:</b>	3 min.	
<b>Set-up time:</b>	3 min.	

Internal Voltmeter (VM) is used to measure TTL level changes transmitted to **A14 Module Switch Driver** control lines.

**Run Test**

1. Switch instrument to **Standby**.
2. Extend **A14 Module** on extender posts and disconnect cable **W7** from **A5 Assembly** at **A5J7**. (See table on foldout in **MECHANICAL PROCEDURES** to locate **A14 Module** extension and **A5** cable disconnection information.)
3. Connect **VM** probe:
  - Connect red alligator clip and pointed tip probe to red test lead provided in On-Site Service Kit.
  - Connect alligator clip to **VM IN (A4TP1)**. (See **A14 MODULE CABLE CONNECTION LOCATOR** on fold-out for **VM IN** location.)
4. Turn instrument on.

**Check High State**

5.        
(To specify high state.)

**NOTE**

*A "0" will appear in display indicating that the data bit will be set low. However, the bit is inverted in the Control Section before it is sent to A14.*

6.     
(To select bit.)
-

**A14 MODULE DIAGNOSTICS**

7. Connect VM probe to solder-side of A5J7 line HET A (pin 1). (See Figure 3L-4, A5J7 Signal Locator.)

**Figure 3L-4. A5J7 Signal Locator  
(Solder-Side View)**

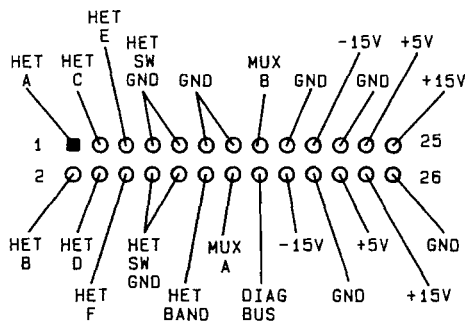

8.     
(To enable voltmeter.)
9. Voltage should read approximately +20 Vdc.
10. Check each driver line (pins 1-6) by connecting VM probe to each pin and keying  .

**Check Low State**

11.        
(To specify low state.)

**NOTE**

*A "1" will appear in display indicating that the data bit will be set high. However, the bit is inverted in the Control Section before it is sent to A14.*

12.     
(To select bit.)

---

**A14 MODULE DIAGNOSTICS**

---

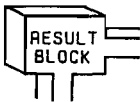
13. Connect **VM** probe to solder-side of **A5J7** line **HET A** (pin **1**).
14. **2** **5** **HZ**  
(To enable voltmeter.)
15. Voltage should read approximately **0 Vdc**.  
(**5** **HZ** to repeat measurement.)
16. Check each driver line (pins **1-6**).
17. Record test results.
18. Return to foldout:
  - ◆ Determine next task by comparing test results to conditions shown in each  for **TEST CABLE W7 SW LINES**.

---

**A14 MODULE DIAGNOSTICS**

---

<b>Type:</b>	4, Voltage Measurements	<b>A14.17</b>
<b>Run time:</b>	2 min.	
<b>Set-up time:</b>	2 min.	

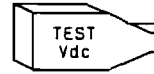

Internal Voltmeter (VM) is used to check power supply levels at inputs to A14 Module.

**Run Test**

1. Switch instrument to Standby:
  - Disconnect W7 from A14 at A14A2 J2.
  - Plug end of W7 into 16 pin test connector, from On-Site Service Kit.

**NOTE**

*Find arrowhead on test connector and align with arrowhead on cable plug W7P2.*

2. Connect VM probe:
  - Connect red alligator clip and retractable hook probe to red test lead provided in On-Site Service Kit.
  - Connect alligator clip to VM IN (A4TP1). (See A14 MODULE CABLE CONNECTION LOCATOR on fold-out for VM IN location.)
  
3. Turn instrument on and enter:
 

SHIFT	SPCL	3	2	5	HZ
-------	------	---	---	---	----

 (To enable Internal Voltmeter.)

**A14 MODULE DIAGNOSTICS**

4. Measure voltage levels:
  - Connect VM probe to test connector pin for each power supply line (see Figure 3L-5. Cable Plug W7P2 Signal Locator).
  - **5** **HZ** (To make each voltage measurement.)

**Figure 3L-5. Cable Plug W7P2 Signal Locator**

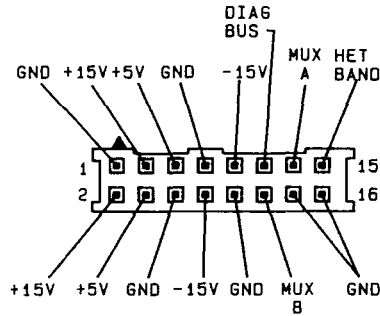

5. Record test results.
6. Return to foldout:
  - Determine next task by comparing test results to conditions shown in each

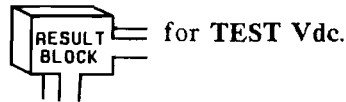

---

**A14 MODULE DIAGNOSTICS**

---

<b>Type:</b>	4, Voltage Measurements	<b>A14.18</b>
<b>Run time:</b>	2 min.	
<b>Set-up time:</b>	3 min.	

Internal Voltmeter (VM) is used to check power supply levels at A5J2.

### Run Test

1. Switch instrument to **Standby**.
2. Extend **A14 Module** on extender posts, from On-Site Service Kit, and disconnect cable **W7** from **A5 Assembly** at **A5J2**. (See table on foldout in **MECHANICAL PROCEDURES** to locate **A14 Module** extension and **A5** cable disconnection information.)
3. Connect VM probe:
  - Connect red alligator clip and pointed tip probe to red test lead provided in On-Site Service Kit.
  - Connect alligator clip to **VM IN (A4TP1)**. (See **A14 MODULE CABLE CONNECTION LOCATOR** on fold-out for **VM IN** location.)
4. Turn instrument on and enter:  
       
 (To enable Internal Voltmeter.)

**A14 MODULE DIAGNOSTICS**

5. Measure all voltage levels at A5J7:
  - Access signals from solder-side of A5J7. (See Figure 3L-6, A5J7 Signal Locator.)
  - 5 HZ (To make each voltage measurement.)

**Figure 3L-6. A5J7 Signal Locator**  
(Solder-Side View)

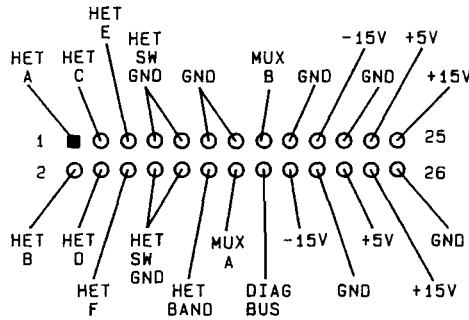

6. Record test results.
7. Return to folout:
  - Determine next task by comparing test results to conditions shown in each PS LINES.

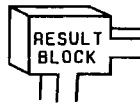

for TEST CABLE W7

---

**A14 MODULE DIAGNOSTICS**

---

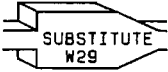
<b>Type:</b>	Cable Substitution	<b>A14.19</b>
<b>Run Time:</b>	5 min.	
<b>Set-up Time:</b>	1 min.	

1. Testing has shown cable **W29** or **W34** to be suspect, temporarily replace **W29** with a test cable from the On-Site Service Kit. Cable **W34** should be replaced by a semi-rigid cable. Rerun **INSTRUMENT LEVEL DIAGNOSTICS (ILD)** to confirm repair.
2. Refer to **REPLACEABLE PARTS**, in HP 8642A/B Operating and Service Manual, for information to order a permanent replacement cable.
3. Return to foldout.



---

**A14 MODULE DIAGNOSTICS**

---

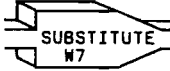
<b>Type:</b>	Cable Substitution	<b>A14.20</b>
<b>Run time:</b>	0 min.	
<b>Set-up time:</b>	3 min.	

Testing has shown cable **W7** to be suspect, temporarily replace with a spare ribbon cable if available. Rerun **INSTRUMENT LEVEL DIAGNOSTICS (ILD)** to confirm repair.

Refer to **REPLACEABLE PARTS**, in HP 8642A/B Operating and Service Manual, for information to order a permanent replacement cable.

**CAUTION**

*When connecting ribbon cable to A14 Module, find arrowhead on the cable plug and align with arrowhead on the board connector.*

**Reconnect W7**

1. Switch instrument to **Standby** to connect cable **W7** to **A5** Assembly and **A14** Module. (Refer to table on foldout in **MECHANICAL PROCEDURES** for information on connecting cable **W7** to **A5J7**.)
2. Return to foldout.

---

**A14 MODULE DIAGNOSTICS**

---

<b>Type:</b>	Cable Connection	<b>A14.21</b>
<b>Run time:</b>	0 min.	
<b>Set-up time:</b>	3 min.	

**CAUTION**

*When connecting ribbon cable to A14 Module, find arrowhead on the cable plug and align with arrowhead on the board connector.*

**Reconnect W7**

1. Switch instrument to Standby to reconnect cable **W7** to **A5** Assembly or **A14** Module. (Refer to table on foldout in **MECHANICAL PROCEDURES** for information on reconnecting cable **W7** to **A5J7**.)
2. Return to foldout.

---

**A14 HETERODYNE MODULE THEORY OF OPERATION**

---

**3L-5. A14 HETERODYNE MODULE****COMMENT**

*It is not essential to understand the internal operation of a module to make an on-site repair.*

The **A14** Module switches the RF Signal sent from the **A13** Module, between a through path and the heterodyne path. The heterodyne path down converts the main band signal by mixing it with either **45 MHz** or **832.5 MHz** to produce the two heterodyne bands. Together these two bands provide the output frequency range **100 kHz** to **4.12 MHz**.

The **45 MHz** signal is a timebase output sent from the **A6** Module. The **832.5 MHz** signal is generated by a voltage controlled oscillator within **A14** which is phase locked to the **45 MHz** timebase signal.

The **Switch Drive**, for controlling the path selection switches, is provided by the **A17** Module in the Power Supply Section.

See the **A14 MODULE SIMPLIFIED BLOCK DIAGRAM** for further understanding of the **A14** Module's internal operation.

---

**A16 (OPTION 003) ATTENUATOR MODULE**

---

**3M-1. INTRODUCTION**

The **MODULE LEVEL DIAGNOSTICS (MLD)** contained in this section are used to further interrogate the **A16 (Option 003) Module (HP 8642A only)**. The objective is to isolate the failure indicated for this module to the module itself or to a part on which it depends for operation.

**NOTE**

*At this level of testing, recommendations for further action are made on the assumption that the **INSTRUMENT LEVEL DIAGNOSTICS (ILD)** showed no failures for modules A01-14 or A17. (For information on using the on-site diagnostics, refer to the **INTRODUCTION** section of this manual.)*

**CAUTION**

*When tightening the coax cable connectors, do not exceed a torque of 1.0 Nm or .74 ft-lbs (slightly tighter than finger tight).*

*When coax cables are disconnected from instrument, do not allow loose ends to come in contact with any exposed circuitry susceptible to short circuiting.*

**Test Instructions**

1. The instrument's **Top Cover** must be removed to run many of these tests. (Refer to table on foldout in **MECHANICAL PROCEDURES** to locate instructions.)
2. The last page in this group of tests is a foldout and should be pulled out now.
3. Turn to the next page to begin the **A16 MLD**.

---

**A16 (Option 003) MODULE SUBSTITUTION**

---

**3M-2. INTRODUCTION****NOTE**

*If a known good module is not available, proceed to the next page, A16 (Option 003) INPUTS VERIFICATION.*

The first step in isolating an A16 (Option 003) failure is to substitute in a known good module from the On-site Service Kit.

**A16 (Option 003) Substitution Instructions**

1. Find **A16 (Option 003) MODULE SUBSTITUTION** on the foldout.
  2. Use the Task Sequence Diagram, shown under **A16 (Option 003) MODULE SUBSTITUTION**, to direct you through the substitution process. Each Task Arrow shown in the diagram indicates a task title and task number. The tasks are numbered according to the order in which they are arranged in this section. Turn to the task indicated and complete the procedure.
  3. After completing the procedure, return to the Task Sequence Diagram on the foldout and determine the next task to be performed.
  4. Begin now by performing the first task shown on the diagram.
-

---

**A16 (Option 003) INPUTS VERIFICATION**

---

**3M-3. INTRODUCTION**

If a known good **A16 (Option 003) Module** is not available or, if you were not able to isolate the failure using the **A16 (OPTION 003) MODULE SUBSTITUTION** procedure, the Task Sequence Diagrams (shown under **A16 (OPTION 003) INPUTS VERIFICATION**) should be used to check each signal path into the **A16 (Option 003) Module**.

**A16 (Option 003) Inputs Verification Instructions**

1. Find **A16 (OPTION 003) INPUTS VERIFICATION** on the foldout.
2. The Task Sequence Diagrams, shown under **A16 (OPTION 003) INPUTS VERIFICATION**, are separated into three checks: **RF, Control and Power Supply** signals.
3. Use the Task Sequence Diagrams to direct you through the verification process. Each Task Arrow shown in a diagram indicates a task title and task number. The tasks are numbered according to the order in which they are arranged in this section. Turn to the task indicated and complete the procedure.
4. After completing the procedure, return to the Task Sequence Diagram on the foldout and determine the next task to be performed.
5. Begin now by performing the first task shown under **1. A16 POWER SUPPLY INPUT CHECK**.

**NOTE**

*The **A16 (OPTION 003) MODULE I/O SIGNALS DIAGRAM** shows all parts which the **A16 (Option 003) Module** depends on for operation.*

---

---

**A16 (OPTION 003) MODULE DIAGNOSTICS**

---

Type:	2A; RF Power Levels	A16.22
Run time:	1 min.	
Set-up time:	2 min.	

RF signal level is measured using Internal Power Meter (PM).

CAUTION

*Do not permit end of Internal Power Meter cable to short circuit instrument by coming in contact with any exposed circuitry.*

### Run Test

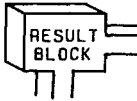
1. **INSTR PRESET** **SHIFT**  
(Hold shift key until "100.000000MZ -140.0DM" appears, to override 20 second reset test.)
2. **SHIFT** **SPCL** **3** **3** **6** **3** **HZ**
3. When "WAITING FOR SET-UP 1 .V24" appears:
  - Disconnect cable W300 from A14 Module at A14U1 J3.
  - Connect **YELLOW PM** cable and adapters to A14 Module at A14U1 J3.
  - **HZ** to continue test.
4. When "WAITING FOR SET-UP 2 .V25" appears:
  - Reconnect cable W300 to A14 Module at A14U1 J3.
  - Disconnect W301 cable from A16 Module at A16A2 J2.
  - Connect PM cable and adapters to module at A16A2 J2.
  - **HZ** to continue test.
5. When "DIAG DONE HIT MSSGS .V1" appears:
  - Reconnect cable W301 to module at A16A2 J2.
  - Use **MSSG** to scroll through messages.
  - Record error code(s) displayed for A16.
6. Return to foldout:
  - Determine next task by comparing test results to conditions shown in each  for TEST RF POWER.

---

**A16 (OPTION 003) MODULE DIAGNOSTICS**

---

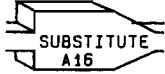
Type:	Module Substitution	A16.23
Run time:	0	
Set-up time:	7 min.	

**Connect Substitute Module**

1. Switch instrument to **Standby**.
2. Remove **A16 (Option 003) Module** and install substitute module (refer to table on foldout in **MECHANICAL PROCEDURES** to locate **A16** removal and replacement information).
3. Turn instrument on.
4. Return to foldout.



---

**A16 (OPTION 003) MODULE DIAGNOSTICS**

---

Type:	Module Substitution	A16.24
Run time:	0	
Set-up time:	7 min.	

**Connect Module**

1. Switch instrument to **Standby**.
2. Remove substitute **A16 (Option 003) Module** and replace instrument's **A16 (Option 003) Module**.
3. Return substitute **A16 (Option 003) Module** to On-Site Service Kit.
4. Return to foldout.

---

**A16 (OPTION 003) MODULE DIAGNOSTICS**

---

Type:	4, Voltage Measurements	<b>A16.25</b>
Run time:	2 min.	
Set-up time:	2 min.	

Internal Voltmeter (VM) is used to check power supply levels at inputs to A16 (Option 003) Module.

**Run Test**

- Switch instrument to Standby:
  - Disconnect W11 from A16 (Option 003) at A16A1 J2.
  - Plug end of W11 into 34 pin test connector, from On-Site Service Kit.

**NOTE**

*Find arrowhead on test connector and align with arrowhead on cable plug W11P2.*

- Connect VM probe:
  - Connect red alligator clip and retractable hook probe to red test lead provided in On-Site Service Kit.
  - Connect alligator clip to VM IN (A4TP1). (See A16 (OPTION 003) MODULE CABLE CONNECTION LOCATOR on foldout for VM IN location.)
- Turn instrument on and enter:
 

SHIFT	SPCL	3	2	5	HZ
-------	------	---	---	---	----

 (To enable Internal Voltmeter.)

**A16 (OPTION 003) MODULE DIAGNOSTICS**

4. Measure voltage levels:
  - Connect VM probe to test connector pin for each power supply line including +20V ATN/SW lines. (See Figure 3M-1. Cable Plug W11P2 Signal Locator).
  - 5 HZ (To make each voltage measurement.)

Figure 3M-1. Cable Plug W11P2 Signal Locator

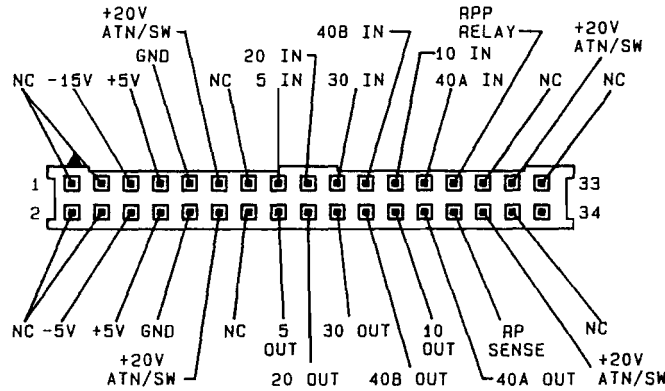

5. Record test results.
6. Return to foldout:
  - Determine next task by comparing test results to conditions shown in each RESULT BLOCK for TEST Vdc.

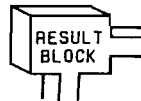

---

**A16 (OPTION 003) MODULE DIAGNOSTICS**

---

Type:	4, Voltage Measurements	<b>A16.26</b>
Run time:	2 min.	
Set-up time:	3 min.	

Internal Voltmeter (VM) is used to check power supply levels at A5J2.

### Run Test

1. Switch instrument to Standby.
2. Extend **A16 (Option 003) Module** on extender posts, from On-Site Service Kit, and disconnect cable **W11** from **A5 Assembly** at **A5J8**. (Refer to table on foldout in **MECHANICAL PROCEDURES** to locate **A16 (Option 003) Module** extension and **A5** cable disconnection information.)
3. Connect **VM** probe:
  - Connect red alligator clip and pointed tip probe to red test lead provided in On-Site Service Kit.
  - Connect alligator clip to **VM IN (A4TP1)**. (See **A16 (OPTION 003) MODULE CABLE CONNECTION LOCATOR** on foldout for **VM IN** location.)
4. Turn instrument on and enter:  
       
 (To enable Internal Voltmeter.)

**A16 (OPTION 003) MODULE DIAGNOSTICS**

5. Measure voltage levels at **A5J8**:
  - Access signals from solder-side of **A5J8**. (See Figure 3M-2. **A5J8 Signal Locator**.)
  - **5 HZ** (To make each voltage measurement.)

**Figure 3M-2. A5J8 Signal Locator (Solder-Side View)**

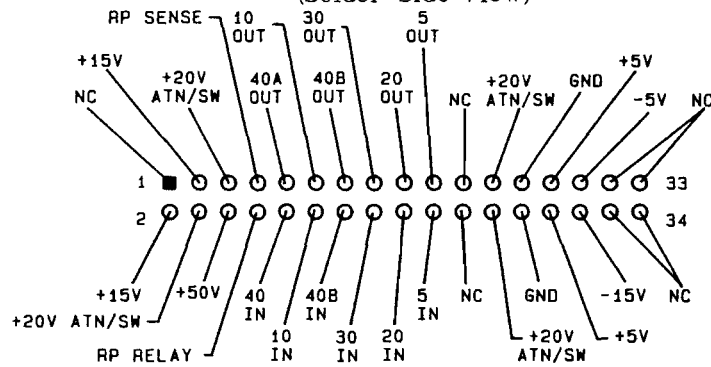

6. Record test results.
7. Return to foldout:
  - Determine next task by comparing test results to conditions shown in each **RESULT BLOCK** for **TEST CABLE W11 PS LINES**.

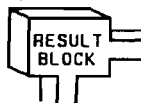

**A16 (OPTION 003) MODULE DIAGNOSTICS**

Type: Run time: Set-up time:	3; Driver Transmission 1 min. 0	<b>A16.27</b>	
------------------------------------	---------------------------------------	---------------	--

Attenuator drive lines are checked by separately selecting relays and listening for attenuator pads to click in and out.

**NOTE**

*Instrument's Top Cover should be removed to perform this test.*

**Run Test**

1.    
 (Hold shift key until "100.000000MZ -140.0DM" appears, to override 20 second reset test.)
2. Set instrument to zero attenuation:  
 •
3. Check relay drivers:
  - Select **Amplitude Setting for Attenuator Relay** to be tested (from **Table 3M-1, Attenuator Relay Selection**) and listen for pad to click in.
  - Select    and listen for attenuator pad to click out.
  - Repeat process for each relay listed in **Table 3M-1**.

**Table 3M-1. Attenuator Relay Selection**

Test Order	Amplitude Setting	Attenuator Relay
1	<input type="button" value="0"/> <input type="button" value="DBM"/>	5 dB pad
2	<input type="button" value="-"/> <input type="button" value="5"/> <input type="button" value="DBM"/>	10 dB pad
3	<input type="button" value="-"/> <input type="button" value="1"/> <input type="button" value="5"/> <input type="button" value="DBM"/>	20 dB pad
4	<input type="button" value="-"/> <input type="button" value="2"/> <input type="button" value="5"/> <input type="button" value="DBM"/>	30 dB pad

---

**A16 (OPTION 003) MODULE DIAGNOSTICS**

---

**NOTE**

*This procedure does not check the two 40 dB relay drivers. They can be checked using an external power measuring device connected at the output of A16 (Option 003). Check power out at settings of -60.1 dBm to -100 dBm (40 dB pad A) and -100.1 to -140 dBm (40 dB pad B).*

4. Record test results.
5. Return to foldout:
  - Determine next task by comparing test results to conditions shown in each **LINES**.

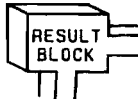

for **TEST ATN DRIVE**

**A16 (OPTION 003) MODULE DIAGNOSTICS**

Type:	RF Power	A16.28
Run time:	1 min.	
Set-up time:	2 min.	

Internal Power Meter (PM) is used to test output power levels.

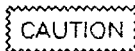

*If an external power measuring instrument is available, use it to make power measurements.*

**Run Test**

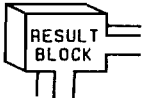
1. **[INSTR PRESET] [SHIFT]**  
 (Hold shift key until "100.000000MZ -140.0DM" appears, to override 20 second reset test.)
2. **[SHIFT] [SPCL] [3] [3] [6] [3] [HZ]**
3. When "WAITING FOR SET-UP 1 .V24" appears:
  - Disconnect cable W300 from A14 Module at A14U1 J3.
  - Connect **YELLOW** PM cable to A14 Module at A14U1 J3.
  - **[HZ]** to continue test.
4. When "WAITING FOR SET-UP 2 .V25" appears:
  - Reconnect cable W300 to A14 Module at A14U1 J3.
  - Connect **PM** cable and adapters to instrument's **RF Output port CP1**.
  - **[HZ]** to continue test.
5. When "DIAG DONE HIT MSSGS.V1" appears:
  - Use **[MSSG]** to scroll through messages.
  - Record error code(s) displayed for A16.
6. Return to foldout:
  - Determine next task by comparing test results to conditions shown in each  for **TEST OUTPUT POWER**.



**A16 (OPTION 003) MODULE DIAGNOSTICS**

Type:	RF Power	A16.29
Run time:	1 min.	
Set-up time:	2 min.	

Internal Power Meter (PM) is used to test output power levels.

**Run Test**

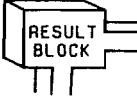
1.    
 (Hold shift key until "100.000000MZ -140.0DM" appears, to override 20 second reset test.)
2.
3. When "WAITING FOR SET-UP 1 .V24" appears:
  - Disconnect cable W300 from A14 Module at A14U1 J3.
  - Connect YELLOW PM cable and adapters to A14 Module at A14U1 J3.
  - to continue test.
4. When "WAITING FOR SET-UP 2 .V25" appears:
  - Reconnect cable W300 to A14 Module at A14U1 J3.
  - Disconnect W301 cable from A16 Module at A16A2 J2.
  - Connect PM cable and adapters to module at A16A2 J2.
  - to continue test.
5. When "DIAG DONE HIT MSSGS .V1" appears:
  - Reconnect cable W301 to module at A16A2 J2.
  - Use  to scroll through messages.
  - Record error code(s) displayed for A16.
6. Return to foldout:
  - Determine next task by comparing test results to conditions shown in each  for TEST A16 OUTPUT.

**A16 (OPTION 003) MODULE DIAGNOSTICS**

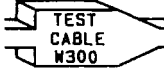
Type:	RF Power	A16.30
Run time:	1 min.	
Set-up time:	2 min.	

Internal Power Meter (PM) is used to test output power levels.

**Run Test**

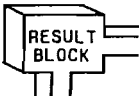
1. **INSTR PRESET** **SHIFT**  
 (Hold shift key until "100.000000MZ -140.0DM" appears, to override 20 second reset test.)
2. **SHIFT** **SPCL** **3** **3** **6** **3** **HZ**
3. When "WAITING FOR SET-UP 1 .V24" appears:
  - Disconnect cable **W300** from **A14** Module at **A14U1 J3**.
  - Connect **YELLOW** PM cable and adapters to **A14** Module at **A14U1 J3**.
  - **HZ** to continue test.
4. When "WAITING FOR SET-UP 2 .V25" appears:
  - Disconnect cable **W300** from **A16** Module at **A16AT1 J1**.
  - Connect flexible coax cable from On-Site Service Kit to modules at **A14U1 J3** and **A16AT1 J1**.
  - Disconnect **W301** cable from **A16** Module at **A16A2 J2**.
  - Connect **PM** cable and adapters to module at **A16A2 J2**.
  - **HZ** to continue test.
5. When "DIAG DONE HIT MSSGS .V1" appears:
  - Reconnect cable **W301** to module at **A16A2 J2**.
  - If power test still fails, reconnect semi-rigid cable **W300** to **A14** and **A16** modules.
  - Use **MSSG** to scroll through messages.
  - Record error code(s) displayed for **A16**.
6. Return to foldout:
  - Determine next task by comparing test results to conditions shown in each  for **TEST CABLE W300**.

---

**A16 (OPTION 003) MODULE DIAGNOSTICS**

---

Type:	RF Power	A16.31
Run time:	1 min.	
Set-up time:	2 min.	

Internal Power Meter (PM) is used to test output power levels.

**Run Test**

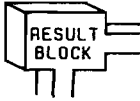
1. **INSTR PRESET** **SHIFT**  
(Hold shift key until "100.000000MZ -140.0DM" appears, to override 20 second reset test.)
2. **SHIFT** **SPCL** **3** **3** **6** **3** **HZ**
3. When "WAITING FOR SET-UP 1 .V24" appears:
  - Disconnect cable **W300** from **A14** Module at **A14U1 J3**.
  - Connect **YELLOW PM** cable to **A14** Module at **A14U1 J3**.
  - **HZ** to continue test.
4. When "WAITING FOR SET-UP 2 .V25" appears:
  - Reconnect cable **W300** to **A14** Module at **A14U1 J3**.
  - Disconnect **W301** cable from **A16** Module at **A16A2 J2** and from cable **W16** at **W16P2** (**W200** on Option **002**, rear panel, instruments).
  - Connect flexible coax cable, from On-Site Service Kit, to **A16** Module and cable **W16**.
  - Connect **PM** cable and adapters to instrument's **RF Output** port **CP1**.
  - **HZ** to continue test.
5. When "DIAG DONE HIT MSSGS .V1" appears:
  - If power test still fails, reconnect semi-rigid cable **W301** to **A16** and **W16**.
  - Use **MSSG** to scroll through messages.
  - Record error code(s) displayed for **A16**.
6. Return to foldout:
  - Determine next task by comparing test results to conditions shown in each  for **TEST CABLE W301**.

---

**A16 (OPTION 003) MODULE DIAGNOSTICS**

---

Type:	Cable Substitution	<b>A16.32</b>
Run Time:	5 min.	
Set-up Time:	1 min.	

1. Testing has shown cable **W300** or **W301** to be suspect, replace with a semi-rigid cable. Rerun **INSTRUMENT LEVEL DIAGNOSTICS (ILD)** to confirm repair.
2. Refer to **REPLACEABLE PARTS**, in **HP 8642A/B** Operating and Service Manual, for information to order a replacement cable.
3. Return to foldout.

---

**A16 (OPTION 003) MODULE DIAGNOSTICS**

---

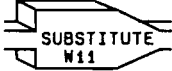
Type:	Cable Substitution	<b>A16.33</b>
Run time:	0 min.	
Set-up time:	3 min.	

Testing has shown cable **W11** to be suspect, temporarily replace with a spare ribbon cable if available. Rerun **INSTRUMENT LEVEL DIAGNOSTICS (ILD)** to confirm repair.

Refer to **REPLACEABLE PARTS** in HP 8642A/B Operating and Service Manual for information to order a permanent replacement cable.

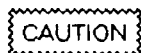

*When connecting ribbon cable to A16 (Option 003) Module, find arrowhead on the cable plug and align with arrowhead on the board connector.*

**Reconnect W11**

1. Switch instrument to **Standby** to connect cable **W11** to **A5 Assembly** and **A16 (Option 003) Module**. (Refer to table on foldout in **MECHANICAL PROCEDURES** for information on connecting cable **W11** to **A5J8**.)
2. Return to foldout.

---

**A16 (OPTION 003) MODULE DIAGNOSTICS**

---

Type:	Cable Connection	<b>A16.34</b>
Run time:	0 min.	
Set-up time:	3 min.	

**CAUTION**

*When connecting ribbon cable to A16 (Option 003) Module, find arrowhead on the cable plug and align with arrowhead on the board connector.*

**Reconnect W11**

1. Switch instrument to **Standby** to reconnect cable **W11** to **A5 Assembly** or **A16 (Option 003) Module**. (Refer to table on foldout in **MECHANICAL PROCEDURES** for information on reconnecting cable **W11** to **A5J8**.)
2. Return to foldout.

---

**A16 (OPTION 003) THEORY OF OPERATION**

---

**3M-4. A16 (OPTION 003) ATTENUATOR MODULE****COMMENT**

*It is not essential to understand the internal operation of a module to make an on-site repair.*

The **A16 (Option 003) Attenuator Module** is included in the **HP 8642A** only. This module provides level attenuation for the RF output signal. Two attenuator assemblies connected in series provide level attenuation to **-140 dBm**. The second attenuator assembly includes reverse power protection circuitry for the **RF Output** port. The attenuator and reverse power control signals are sent to the **A16 (Option 003) Module** from the **A17 Module** in the **Power Supply Section**.

The RF output signal from the **A16 Module** is routed directly to the **HP 8642A's RF Output** port.

With an **A16 (Option 003) Module** installed the output power level for an **HP 8642A** is increased to **+20 dBm** for the frequency range **264.3 to 528.7 MHz** and to **+19 dBm** for the frequency range **528.7 to 1057.5 MHz**.

See the **A16 (OPTION 003) MODULE SIMPLIFIED BLOCK DIAGRAM** for further understanding of the **A16 (Option 003) Module's** internal operation.

---

## A19 DOUBLER/ATTENUATOR MODULE

---

### 3N-1. INTRODUCTION

The **MODULE LEVEL DIAGNOSTICS (MLD)** contained in this section are used to further interrogate the **A19 Module (HP 8642B only)**. The objective is to isolate the failure indicated for this module to the module itself or to a part on which it depends for operation.

#### NOTE

*At this level of testing, recommendations for further action are made on the assumption that the **INSTRUMENT LEVEL DIAGNOSTICS (ILD)** showed no failures for modules **A01-A17**. (For information on using the on-site diagnostics, refer to the **INTRODUCTION** section of this manual.)*

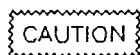

*When tightening the coax cable connectors, do not exceed a torque of 1.0 Nm or .74 ft-lbs (slightly tighter than finger tight).*

*When coax cables are disconnected from instrument, do not allow loose ends to come in contact with any exposed circuitry susceptible to short circuiting.*

#### Test Instructions

1. The instrument's **Top Cover** must be removed to run many of these tests. (Refer to table on foldout in **MECHANICAL PROCEDURES** to locate instructions.)
2. The last page in this group of tests is a foldout and should be pulled out now.
3. Turn to the next page to begin the **A19 MLD**.



---

**A19 MODULE SUBSTITUTION**

---

**3N-2. INTRODUCTION****NOTE**

*If a known good module is not available, proceed to the next page, A19 INPUTS VERIFICATION.*

The first step in isolating an A19 failure is to substitute in a known good module from the On-site Service Kit.

**A19 Substitution Instructions**

1. Find **A19 MODULE SUBSTITUTION** on the foldout.
  2. Use the Task Sequence Diagram, shown under **A19 MODULE SUBSTITUTION**, to direct you through the substitution process. Each Task Arrow shown in the diagram indicates a task title and task number. The tasks are numbered according to the order in which they are arranged in this section. Turn to the task indicated and complete the procedure.
  3. After completing the procedure, return to the Task Sequence Diagram on the foldout and determine the next task to be performed.
  4. Begin now by performing the first task shown on the diagram.
-

---

## A19 INPUTS VERIFICATION

---

### 3N-3. INTRODUCTION



If a known good **A19 Module** is not available or, if you were not able to isolate the failure using the **A19 MODULE SUBSTITUTION** procedure, the Task Sequence Diagrams (shown under **A19 INPUTS VERIFICATION**) should be used to check each signal path into the **A19 Module**.

#### A19 Inputs Verification Instructions

1. Find **A19 INPUTS VERIFICATION** on the foldout.
2. The Task Sequence Diagrams, shown under **A19 INPUTS VERIFICATION**, are separated into three checks: **RF, Control and Power Supply** signals.
3. Use the Task Sequence Diagrams to direct you through the verification process. Each Task Arrow shown in a diagram indicates a task title and task number. The tasks are numbered according to the order in which they are arranged in this section. Turn to the task indicated and complete the procedure.
4. After completing the procedure, return to the Task Sequence Diagram on the foldout and determine the next task to be performed.
5. Begin now by performing the first task shown under **1. POWER SUPPLY INPUT CHECK**.

#### NOTE

*The **A19 MODULE I/O SIGNALS DIAGRAM** shows all parts which the **A19 Module** depends on for operation.*

---

**A19 MODULE DIAGNOSTICS**

---

Type:	1; Loop Lock/Unlock	A19.02
Run time:	40 sec.	
Set-up time:	0	

**Run Test**

1. **INSTR PRESET** **SHIFT**  
 (Hold shift key until "100.00000MZ -140.0DM" appears, to override 20 second reset test.)
2. **SHIFT** **SPCL** **3** **3** **5** **8** **HZ**.
3. When "DIAG DONE HIT MSSG .V1" appears:
  - Use **MSSG** to scroll through messages.
  - Record error code(s) displayed for **A19**.

**COMMENT**

*If any error codes are displayed for modules A01-A17 you need to isolate those failure(s) before performing the A19 MODULE SUBSTITUTION. (Refer to INSTRUMENT LEVEL DIAGNOSTICS to determine correct order for troubleshooting modules.)*

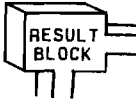
4. Return to foldout:
  - Determine next task by comparing test results to conditions shown in each  for **TEST A19 MODULE**.

---

**A19 MODULE DIAGNOSTICS**

---

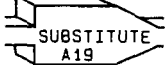
Type:	Module Substitution	<b>A19.03</b>
Run time:	0	
Set-up time:	7 min.	

**Connect Substitute Module**

1. Switch instrument to **Standby**.
2. Remove **A19 Module** and install substitute module (refer to table on foldout in **MECHANICAL PROCEDURES** to locate removal and replacement information).
3. Turn instrument on.
4. Return to foldout.

---

**A19 MODULE DIAGNOSTICS**

---

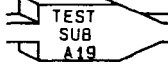
Type:	Substitute Module Test	<b>A19.04</b>
Run time:	40 sec.	
Set-up time:	0	

Test operation of substitute A19 Module by repeating test performed on A19 Module before substitution.

**Run Test**

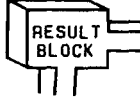
1. **INSTR PRESET** **SHIFT**  
(Hold shift key until "100.000000MZ -140.0DM" appears, to override 20 second reset test.)
2. **SHIFT** **SPCL** **3** **3** **5** **8** **HZ**.
3. When "DIAG DONE HIT MSSG .V1" appears:
  - Use **MSSG** to scroll through messages.
  - Record error code(s) displayed for A19. If "TEST 1 OF A19 (PASSED or FAILED)" is not displayed, rerun test.
4. Return to foldout:
  - Determine next task by comparing test results to conditions shown in each  for **TEST SUB A19**.

---

**A19 MODULE DIAGNOSTICS**

---

Type:	Additional A19 Tests	<b>A19.05</b>
Run time:	Conditional	
Set-up time:	Conditional	

The **A19** failure conditions for arriving at this task are described below. Follow the procedure for the condition which fits your module.

- Condition 1:** Instrument Level Self Test indicated **A19** failure.
- Condition 2:** Instrument has a power level failure and **A14** Module RF Power Level Test indicated power level good out of **A14**.
- Condition 3:** Instrument must be set to a specific operating condition to detect **A19** failure.

**Condition 1**

1. **INSTR PRESET** **SHIFT**  
(Hold shift key until "100.000000MZ -140.0DM" appears, to override 20 second reset test.)
2. **SHIFT** **SPCL** **3** **3** **0** **HZ**.
3. When "WAITING FOR SET-UP 1 .V24" appears:
  - Connect BNC Tee connector, from On-Site Service Kit, to "FM/ΦM INPUT" (see INSTRUMENT LEVEL DIAGNOSTICS foldout for set-up diagram).
  - Connect a coax cable from Tee connector to "MOD OUTPUT".
  - Connect a coax cable from Tee to "AM/PULSE INPUT"
4. When "DIAG DONE HIT MSSGS .VI" appears:
  - Use **MSSG** to scroll through messages.
  - Record **A19** error codes.

**COMMENT**

*If any error codes are displayed for modules A01-A17, you need to isolate those failure(s) before performing the A19 MODULE SUBSTITUTION. (Refer to INSTRUMENT LEVEL DIAGNOSTICS to determine correct order for troubleshooting modules.)*

5. Return to foldout.
-

---

**A19 MODULE DIAGNOSTICS**

---

**Condition 2****NOTE**

*If an external power measuring instrument is available, use it to make power measurements.*

1. **INSTR PRESET** **SHIFT**  
(Hold shift key until "100.000000MZ -140.0DM" appears, to override 20 second reset test.)
2. Connect Power Meter (PM):
  - Connect Yellow PM cable and adapters to instrument's RF Output port CPI.
3. To use Internal Power Meter:
  - **SHIFT** **SPCL** **2** **4** **HZ**
  - **4** **HZ** to repeat measurement.
  - Key sequence must be repeated for each amplitude or frequency setting change.

**NOTE**

*Internal Power Meter should read within  $\pm 3$  dB of amplitude setting. The internal power meter cannot measure power levels less than -10 dBm.*

4. Measure power level:
  - Set instrument's frequency to 2 GHz.
  - Measure power at amplitude settings of +10, +5, 0 and -5 dBm.
  - Repeat measurement for same amplitude settings at 990 and 4 MHz.
  - Supplement these measurements with additional readings at other instrument settings if desired.
5. Record test results.
6. Return to foldout.

**Condition 3**

1. Set instrument to operating condition which causes A19 failure.
  2. Record instrument set-up and error message(s).
  3. Return to foldout.
-

**A19 MODULE DIAGNOSTICS**

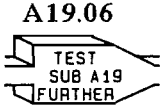
Type:	Additional Substitute	
Run time:	A19 Tests	
Set-up time:	Conditional	

Test operation of substitute A19 Module by repeating test(s) performed on A19 Module before substitution.

- Condition 1: Instrument Level Self Test indicated A19 failure.
- Condition 2: Instrument has a power level failure and A14 Module RF Power Level Test indicated power level good out of A14.
- Condition 3: Instrument must be set to a specific operating condition to detect A19 failure.

**Condition 1**

1. **INSTR PRESET** **SHIFT**  
 (Hold shift key until "100.000000MZ -140.0DM" appears, to override 20 second reset test.)
2. **SHIFT** **SPCL** **3** **3** **0** **HZ**.
3. When "WAITING FOR SET-UP 1 .V24" appears:
  - Connect BNC Tee connector, from On-Site Service Kit, to "FM/ΦM INPUT" (see INSTRUMENT LEVEL DIAGNOSTICS foldout for set-up diagram).
  - Connect a coax cable from Tee connector to "MOD OUTPUT".
  - Connect a coax cable from Tee to "AM/PULSE INPUT"
4. When "DIAG DONE HIT MSSGS .VI" appears:
  - Use **MSSG** to scroll through messages.
  - Record **A19** error codes.

**COMMENT**

*If any error codes are displayed for modules A01-A17, you need to isolate those failure(s) now.*

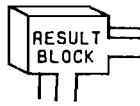
5. Return to foldout.
  - Determine next task by comparing test results to conditions shown in each  for **TEST SUB A19 FURTHER**.



**A19 MODULE DIAGNOSTICS**

---

**Condition 2**

1. **INSTR PRESET** **SHIFT**  
 (Hold shift key until "100.000000MZ -140.0DM" appears, to override 20 second reset test.)
2. Connect Power Meter:
  - Connect Yellow **PM** cable and adapters to instrument's **RF Output** port **CP1**.
3. To use Internal Power Meter:
  - **SHIFT** **SPCL** **2** **4** **HZ**
  - **4** **HZ** to repeat measurement.
  - Key sequence must be repeated for each amplitude or frequency setting change.

**NOTE**

*Internal Power Meter should read within **+/-3 dB** of amplitude setting. The internal power meter cannot measure power levels less than **-10 dBm**.*

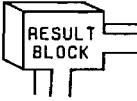
4. Measure power level:
  - Set instrument's frequency to **2 GHz**.
  - Measure power at amplitude settings of **+10, +5, 0** and **-5 dBm**.
  - Repeat measurements for same amplitude settings at **990** and **4 MHz**.
  - Supplement these measurements with additional readings at other instrument settings if desired.
5. Record test results.
6. Return to foldout.
  - Determine next task by comparing test results to conditions shown in each  for **TEST SUB A19 FURTHER**.

**Condition 3**

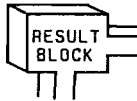
1. Set instrument to operating condition which causes **A19** failure.
  2. Record instrument set-up and error message(s).
  3. Return to foldout:
    - Determine next task by comparing test results to conditions shown in each  for **TEST SUB A19 FURTHER**.
-

---

**A19 MODULE DIAGNOSTICS**

---

Type:	Module Substitution	A19.07
Run time:	0	
Set-up time:	7 min.	

**Connect Module**

1. Switch instrument to Standby.
2. Remove substitute **A19 Module** and replace instrument's **A19 Module**.
3. Return substitute A19 Module to On-Site Service Kit.
4. Return to foldout.

---

**A19 MODULE DIAGNOSTICS**

---

<b>Type:</b>	4, Voltage Measurements	<b>A19.08</b>
<b>Run time:</b>	2 min.	
<b>Set-up time:</b>	2 min.	

Internal Voltmeter (VM) is used to check power supply levels at inputs to **A19** Module.

**Run Test**

1. Switch instrument to Standby:
  - Disconnect **W11** from **A19** at **A19A1 J2**.
  - Plug end of **W11** into **34** pin test connector, from On-Site Service Kit.

**NOTE**

*Find arrowhead on test connector and align with arrowhead on cable plug **W11P2**.*

2. Connect VM probe:
  - Connect red alligator clip and retractable hook probe to red test lead provided in On-Site Service Kit.
  - Connect alligator clip to **VM IN (A4TP1)**. (See **A19 MODULE CABLE CONNECTION LOCATOR** on fold-out for **VM IN** location.)
3. Turn instrument on and enter:
 

SHIFT	SPCL	3	2	5	HZ
-------	------	---	---	---	----

 (To enable Internal Voltmeter.)

**A19 MODULE DIAGNOSTICS**

4. Measure voltage levels:
  - Connect VM probe to test connector pin for each power supply line including +20V ATN/SW lines. (See Figure 3N-1. Cable Plug W11P2 Signal Locator).
  - 5 HZ (To make each voltage measurement.)

Figure 3N-1. Cable Plug W11P2 Signal Locator

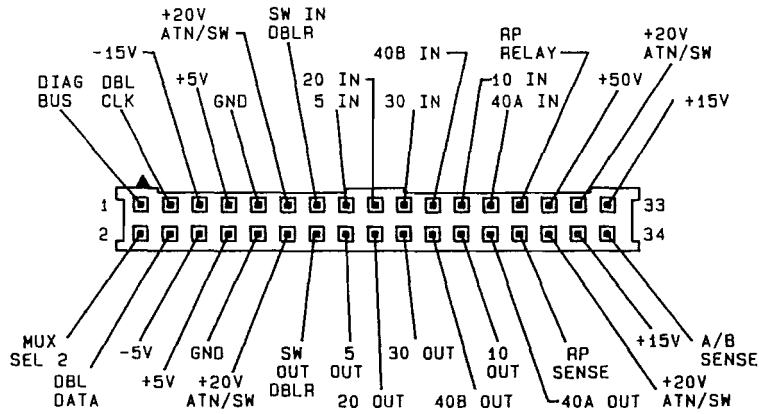

5. Record test results.
6. Return to foldout:
  - Determine next task by comparing test results to conditions shown in each RESULT BLOCK for TEST Vdc.

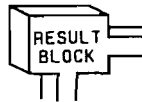

---

**A19 MODULE DIAGNOSTICS**

---

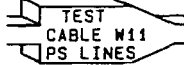
Type:	4, Voltage Measurements	<b>A19.09</b>
Run time:	2 min.	
Set-up time:	3 min.	

Internal Voltmeter (VM) is used to check power supply levels at A5J2.

### Run Test

1. Switch instrument to Standby.
2. Extend **A19 Module** on extender posts, from On-Site Service Kit, and disconnect cable **W11** from **A5 Assembly** at **A5J8**. (Refer to table on foldout in **MECHANICAL PROCEDURES** to locate **A19 Module** extension and **A5** cable disconnection information.)
3. Connect **VM** probe:
  - Connect red alligator clip and pointed tip probe to red test lead provided in On-Site Service Kit.
  - Connect alligator clip to **VM IN (A4TP1)**. (See **A19 MODULE CABLE CONNECTION LOCATOR** on foldout for **VM IN** location.)
4. Turn instrument on and enter:
 

SHIFT	SPCL	3	2	5	HZ
-------	------	---	---	---	----

 (To enable Internal Voltmeter.)

**A19 MODULE DIAGNOSTICS**

5. Measure voltage levels at A5J8:
  - Access signals from solder-side of A5J8. (See Figure 3N-2, A5J8 Signal Locator.)
  - **5** **HZ** (To make each voltage measurement.)

**Figure 3N-2. A5J8 Signal Locator (Solder-Side View)**

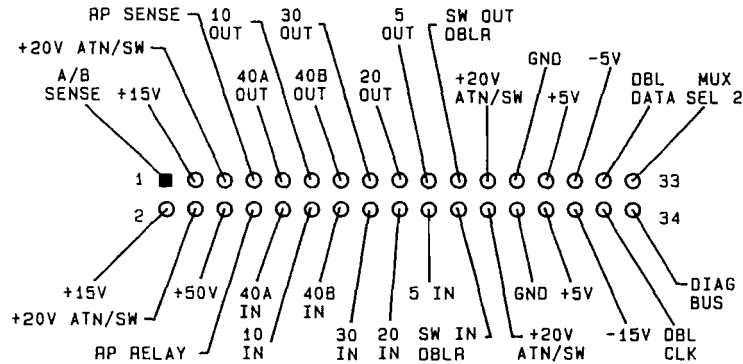

6. Record test results.
7. Return to foldout:
  - Determine next task by comparing test results to conditions shown in each PS LINES.

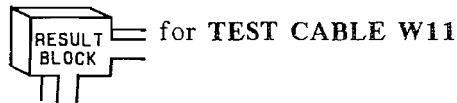

**A19 MODULE DIAGNOSTICS**

<b>Type:</b>	3; Driver Transmission	<b>A19.10</b>
<b>Run time:</b>	1 min.	
<b>Set-up time:</b>	0	

Attenuator drive lines are checked by separately selecting relays and listening for attenuator pads to click in and out.

**NOTE**

*Instrument's Top Cover should be removed to perform this test.*

**Run Test**

1.    
 (Hold shift key until "100.000000MZ -140.0DM" appears, to override 20 second reset test.)
2. Set instrument to zero attenuation:
  -
3. Check relay drivers:
  - Select **Amplitude Setting for Attenuator Relay** to be tested (from **Table 3N-1. A19 Attenuator Relay Selection**) and listen for pad to click in.
  - Select    and listen for attenuator pad to click out.
  - Repeat process for each relay listed in **Table 3N-1.**

**Table 3N-1. Attenuator Relay Selection**

Test Order	Amplitude Setting	Attenuator Relay
1	<input type="button" value="0"/> <input type="button" value="DBM"/>	5 dB pad
2	<input type="button" value="-"/> <input type="button" value="5"/> <input type="button" value="DBM"/>	10 dB pad
3	<input type="button" value="-"/> <input type="button" value="1"/> <input type="button" value="5"/> <input type="button" value="DBM"/>	20 dB pad
4	<input type="button" value="-"/> <input type="button" value="2"/> <input type="button" value="5"/> <input type="button" value="DBM"/>	30 dB pad

---

**A19 MODULE DIAGNOSTICS**

---

**NOTE**

*This procedure does not check the two 40 dB relay drivers. They can be checked using an external power measuring device connected at the output of A19. Check power out at settings of -60.1 dBm to -100 dBm (40 dB pad A) and -100.1 to -140 dBm (40 dB pad B).*

4. Record test results.
5. Return to foldout:
  - Determine next task by comparing test results to condi-

tions shown in each  
LINES.

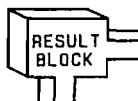

for **TEST ATN DRIVE**



---

**A19 MODULE DIAGNOSTICS**

---

Type:	3; Bit Transmission	<b>A19.11</b>
Run time:	3 min.	
Set-up time:	2 min.	

Internal Voltmeter (VM) is used to measure TTL level changes transmitted to **A19 Module** on Clock and Data control Lines.

**Run Test**

- Switch instrument to Standby:
  - Disconnect cable **W11** from module at **A19A1 J2**.
  - Plug end of **W11** into **34** pin test connector, from On-Site Service Kit.

**NOTE**

*Find arrowhead on test connector and align with arrowhead on cable plug **W11P2**.*

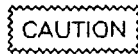

*To prevent damage to the Power Supply and Control sections, do not permit the exposed pins on the test connector to short circuit.*

- Connect VM probe:
  - Connect red alligator clip and retractable hook probe to red test lead provided in On-Site Service Kit.
  - Connect alligator clip to **VM IN (A4TP1)**. (See **A19 MODULE CABLE CONNECTION LOCATOR** on fold-out for **VM IN** location.)
- Turn instrument on.  
(Hold shift key until "**100.000000MZ -140.0DM**" appears, to override 20 second reset test.)

**Clock Line****Check High State**

- SHIFT** **SPCL** **3** **6** **0** **2**  
(To specify high state.)

**NOTE**

*A "0" will appear in display indicating that the data bit will be set low. However, the bit is inverted in the Control Section before it is sent to **A19**.*

---

**A19 MODULE DIAGNOSTICS**

5.     
(To select bit.)
6. Connect VM probe to test connector line **DBL CLK** (pin 32). (See Figure 3N-1. Cable Plug W11P2 Signal Locator.)

**Figure 3N-3. Cable Plug W11P2 Signal Locator**

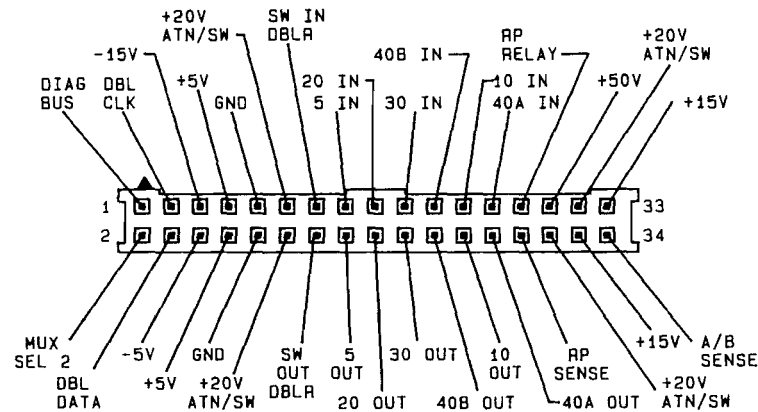

7.     
(To enable voltmeter.)
8. Voltage should read approximately +2.5 to +5.5 Vdc.  
  to repeat measurement.)

**Check Low State**

9.        
(To specify low state.)

**NOTE**

*A "1" will appear in display indicating that the data bit will be set high. However, the bit is inverted in the Control Section before it is sent to A19.*

10.     
(To select bit.)
11.     
(To enable voltmeter.)
12. Voltage should read approximately -0.5 to +1.5 Vdc.  
  to repeat measurement.)

---

**A19 MODULE DIAGNOSTICS**

---

**Data Line****Check High State**

13.  SHIFT  SPCL  3  6  0  2  
(To specify high state.)
14.  2  5  HZ  
(To select bit.)
15. Connect VM probe to test connector line **DBL DATA** (pin 31). (See Figure 3N-3. Cable Plug W11P2 Signal Locator.)
16.  2  5  HZ  
(To enable voltmeter.)
17. Voltage should read approximately **+2.5 to +5.5 Vdc**.  
 5  HZ to repeat measurement.)

**Check Low State**

18.  SHIFT  SPCL  3  6  0  1  
(To specify low state.)
19.  2  5  HZ  
(To select bit.)
20.  2  5  HZ  
(To enable voltmeter.)
21. Voltage should read approximately **-0.5 to +1.5 Vdc**.  
 5  HZ to repeat measurement.)

**Multiplexer Select Line****Check High State**

22.  SHIFT  SPCL  3  6  0  1  
(To specify high state.)
23.  8  HZ  
(To select bit.)
-

---

**A19 MODULE DIAGNOSTICS**

---

24. Connect VM probe to test connector line MUX SEL 2 (pin 33). (See Figure 3N-3. Cable Plug W11P2 Signal Locator.)
25.    (To enable voltmeter.)
26. Voltage should read approximately +2.5 to +5.5 Vdc. (  to repeat measurement.)

**Check Low State**

27.       (To specify low state.)
28.   (To select bit.)
29.    (To enable voltmeter.)
30. Voltage should read approximately -0.5 to +1.5 Vdc. (  to repeat measurement.)
31. Record test results.
32. Return to foldout:
  - ⊙ Determine next task by comparing test results to conditions shown in each **RESULTS** for **TEST CONTROL BITS**.

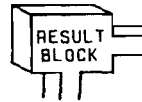

---

**A19 MODULE DIAGNOSTICS**

---

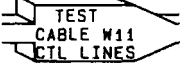
<b>Type:</b>	3; Bit Transmission	<b>A19.12</b>
<b>Run time:</b>	3 min.	
<b>Set-up time:</b>	3 min.	

Internal Voltmeter (VM) is used to measure TTL level changes transmitted to **A19 Module** on SAWR oscillator select lines **A** and **B**.

**Run Test**

1. Switch instrument to **Standby**.
2. Extend **A19 Module** on extender posts, from On-Site Service Kit, and disconnect cable **W11** from **A5 Assembly** at **A5J8**. (Refer to table on foldout in **MECHANICAL PROCEDURES** to locate **A19 Module** extension and **A5** cable disconnection information.)
3. Connect **VM** probe:
  - Connect red alligator clip and pointed tip probe to red test lead provided in On-Site Service Kit.
  - Connect alligator clip to **VM IN (A4TP1)**. (See **A19 MODULE CABLE CONNECTION LOCATOR** on fold-out for **VM IN** location.)
4. Turn instrument on.

**Clock Line****Check High State**

5.  SHIFT  SPCL  3  6  0  2  
(To specify high state.)
  6.  2  4  HZ  
(To select bit.)
-

**A19 MODULE DIAGNOSTICS**

7. Connect VM probe to solder-side of A5J8 line DBL CLK (pin 32). (See Figure 3N-4. A5J8 Signal Locator.)

**Figure 3N-4. A5J8 Signal Locator  
(Solder-Side View)**

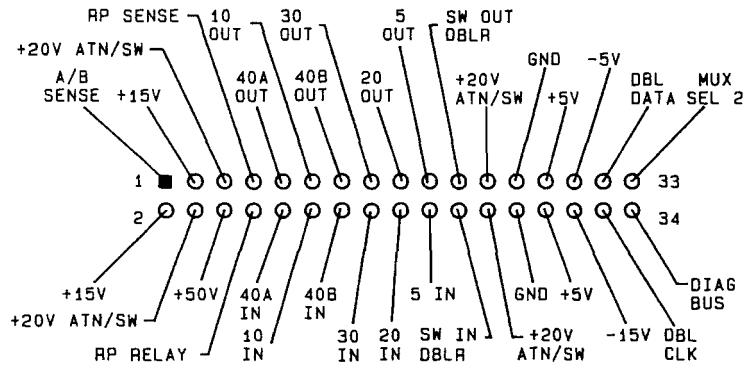

8.    (To enable voltmeter.)
9. Voltage should read approximately +2.5 to +5.5 Vdc.   to repeat measurement.)

**Check Low State**

10.       (To specify low state.)
11.    (To select bit.)
12.    (To enable voltmeter.)
13. Voltage should read approximately -0.5 to +1.5 Vdc.   to repeat measurement.)

**Data Line**

**Check High State**

14.       (To specify high state.)
15.    (To select bit.)

---

**A19 MODULE DIAGNOSTICS**

---

16. Connect VM probe to solder-side of A5J8 line **DBL DATA** (pin 31). (See Figure 3N-4, A5J8 Signal Locator.)
17.     
(To enable voltmeter.)
18. Voltage should read approximately **+2.5 to +5.5 Vdc**.  
(  to repeat measurement.)

**Check Low State**

19.        
(To specify low state.)
20.     
(To select bit.)
21.     
(To enable voltmeter.)
22. Voltage should read approximately **-0.5 to +1.5 Vdc**.  
(  to repeat measurement.)

**Multiplexer Select Line****Check High State**

23.        
(To specify high state.)
  24.    
(To select bit.)
-

**A19 MODULE DIAGNOSTICS**

---

25. Connect **VM** probe to solder-side of **A5J8** line **MUX SEL 2** (pin **33**). (See **Figure 3N-4. A5J8 Signal Locator**.)
26. **2 5 HZ**  
(To enable voltmeter.)
27. Voltage should read approximately **+2.5 to +5.5 Vdc**.  
(**5 HZ** to repeat measurement.)

**Check Low State**

28. **SHIFT SPCL 3 6 0 2**  
(To specify low state.)
29. **8 HZ**  
(To select bit.)
30. **2 5 HZ**  
(To enable voltmeter.)
31. Voltage should read approximately **-0.5 to +1.5 Vdc**.  
(**5 HZ** to repeat measurement.)
32. Record test results.
33. Return to foldout:
  - Determine next task by comparing test results to conditions shown in each

CTL LINES.

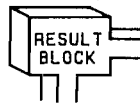

for **TEST CABLE W11**



---

**A19 MODULE DIAGNOSTICS**

---

Type:	RF Power	A19.13
Run Time:	4 min.	
Set-up Time:	3 min.	

Internal Power Meter (PM) is used to test output power levels.

**NOTE**

*If an external power measuring instrument is available, use it to make power measurements.*

**Run Test**

1. **INSTR PRESET** **SHIFT**  
(Hold shift key until "100.000000MZ -140.0DM" appears, to override 20 second reset test.)
2. Connect Power Meter:
  - Connect Yellow **PM** cable and adapters to instrument's **RF Output port CP1**.
3. To use Internal Power Meter:
  - **SHIFT** **SPCL** **2** **4** **HZ**
  - **4** **HZ** to repeat measurement.
  - Key sequence must be repeated for each amplitude or frequency setting change.

**NOTE**

*Internal Power Meter should read within  $\pm 3$  dB of amplitude setting. The internal power meter cannot measure power levels less than  $-10$  dBm.*

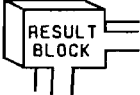
4. Measure power level:
  - Set instrument's frequency to **2 GHz**.
  - Measure power at amplitude settings of **+10, +5, 0** and **-5 dBm**.
  - Repeat measurements for same amplitude settings at **990** and **4 MHz**.
  - Supplement these measurements with additional readings at other instrument settings if desired.
5. Record test results.
6. Return to foldout.
  - Determine next task by comparing test results to conditions shown in each  for **TEST POWER OUTPUT**.

---

**A19 MODULE DIAGNOSTICS**

---

Type:	RF Power	A19.14
Run Time:	4 min.	
Set-up Time:	3 min.	

Internal Power Meter (PM) is used to test output power levels.

**Run Test**

1. **INSTR PRESET** **SHIFT**  
(Hold shift key until "100.000000MZ -140.0DM" appears, to override 20 second reset test.)
2. Connect Power Meter:
  - Disconnect cable **W38** from **A19 Module** at **A19A2 J2**.
  - Connect power meter to module at **A19A2 J2**.
3. To use Internal Power Meter:
  - **SHIFT** **SPCL** **2** **4** **HZ**
  - **4** **HZ** to repeat measurement.
  - Key sequence must be repeated for each amplitude or frequency setting change.

**NOTE**

*Internal Power Meter should read within  $\pm 3$  dB of amplitude setting. The internal power meter cannot measure power levels less than  $-10$  dBm.*

4. Measure power level:
  - Set instrument's frequency to **2 GHz**.
  - Measure power at amplitude settings of **+10, +5, 0** and **-5 dBm**.
  - Repeat measurements for same amplitude settings at **990** and **4 MHz**.
  - Supplement these measurements with additional readings at other instrument settings if desired.
5. Record test results.
6. Return to foldout.
  - Determine next task by comparing test results to conditions shown in each **RESULT BLOCK** for **TEST A19 OUTPUT**.

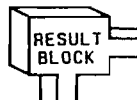

---

**A19 MODULE DIAGNOSTICS**

---

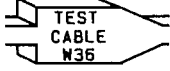
Type:	RF Power	<b>A19.15</b>
Run Time:	4 min.	
Set-up Time:	4 min.	

Internal Power Meter (PM) is used to test output power levels.

**Run Test**

1. **INSTR PRESET** **SHIFT**  
(Hold shift key until "100.000000MZ -140.0DM" appears, to override 20 second reset test.)
2. Connect Power Meter:
  - Disconnect cable **W38** from **A19** Module at **A19A2 J2**.
  - Connect power meter to module at **A19A2 J2**.
3. To use Internal Power Meter:
  - **SHIFT** **SPCL** **2** **4** **HZ**
  - **4** **HZ** to repeat measurement.

**NOTE**

*Internal Power Meter should read within +-3 dB of amplitude setting. The internal power meter cannot measure power levels less than -10 dBm.*

4. Measure power level:
    - Set instrument's frequency to **2 GHz**.
    - Measure power at amplitude settings of **+10, +5, 0** and **-5 dBm**.
    - Repeat measurements for same amplitude settings at **990** and **4 MHz**.
  5. Substitute cable **W36**:
    - Disconnect cable **W36** from **A14** and **A19** modules at **A14U1 J3** and **A19K1 J2**.
    - Connect flexible coax cable from On-Site Service Kit to modules at **A14U1 J3** and **A19K1 J2**.
-

---

**A19 MODULE DIAGNOSTICS**

---

6. Measure power level:
  - Repeat measurements made in step 4.
7. Record test results.
8. If power level still fails, reconnect semi-rigid cable **W36** to **A14** and **A19** modules.
9. Return to foldout.
  - Determine next task by comparing test results to conditions shown in each

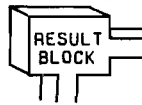

for TEST CABLE **W36**.

---

**A19 MODULE DIAGNOSTICS**

---

Type:	RF Power	<b>A19.16</b>
Run Time:	5 min.	
Set-up Time:	5 min.	

Internal Power Meter (PM) is used to test output power levels.

Run Test

1. **INSTR PRESET** **SHIFT**  
(Hold shift key until "100.000000MZ -140.0DM" appears, to override 20 second reset test.)
2. Connect Power Meter:
  - Connect Yellow PM cable and adapters to instrument's RF Output port CP1.
3. Substitute cable W38:
  - Disconnect cable W38 from A19 Module at A19A2 J2 and from cable W16 at W16P2 (W200 on Option 002, rear panel, instruments).
  - Connect flexible coax cable from On-Site Service Kit to A19 Module and cable W16.
4. To use Internal Power Meter:
  - **SHIFT** **SPCL** **2** **4** **HZ**
  - **4** **HZ** to repeat measurement.
  - Key sequence must be repeated for each amplitude or frequency setting change.

**NOTE**

*Internal Power Meter should read within +-3 dB of amplitude setting. The internal power meter cannot measure power levels less than -10 dBm.*

5. Measure power level:
  - Set instrument's frequency to 2 GHz.
  - Measure power at amplitude settings of +10, +5, 0 and -5 dBm.
  - Repeat measurements for same amplitude settings at 990 and 4 MHz.
6. Record test results.
7. If power level still fails, reconnect semi-rigid cable W38 to A19 Module and cable W16 (W200 Option 002 instruments).
8. Return to foldout.
  - Determine next task by comparing test results to conditions shown in each  for TEST CABLE W38.

---

**A19 MODULE DIAGNOSTICS**

---

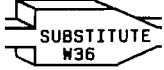
Type:	Cable Substitution	A19.17
Run Time:	5 min.	
Set-up Time:	1 min.	

1. Testing has shown cable **W36** or **W38** to be suspect, replace with a semi-rigid. Rerun **INSTRUMENT LEVEL DIAGNOSTICS (ILD)** to confirm repair.
2. Refer to **REPLACEABLE PARTS**, in HP 8642A/B Operating and Service Manual, for information to order a replacement cable.
3. Return to foldout.

---

**A19 MODULE DIAGNOSTICS**

---

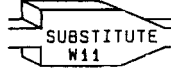
<b>Type:</b>	Cable Substitution	<b>A19.18</b>
<b>Run time:</b>	0 min.	
<b>Set-up time:</b>	3 min.	

Testing has shown cable **W11** to be suspect, temporarily replace with a spare ribbon cable if available. Rerun **INSTRUMENT LEVEL DIAGNOSTICS (ILD)** to confirm repair.

Refer to **REPLACEABLE PARTS** in HP 8642A/B Operating and Service Manual for information to order a permanent replacement cable.

**CAUTION**

*When connecting ribbon cable to A19 Module, find arrowhead on the cable plug and align with arrowhead on the board connector.*

**Reconnect W11**

1. Switch instrument to **Standby** to connect cable **W11** to **A5** Assembly and **A19** Module. (Refer to table on foldout in **MECHANICAL PROCEDURES** for information on connecting cable **W11** to **A5J8**.)
2. Return to foldout.

---

**A19 MODULE DIAGNOSTICS**

---

<b>Type:</b>	Cable Connection	<b>A19.19</b>
<b>Run time:</b>	0 min.	
<b>Set-up time:</b>	3 min.	

**CAUTION**

*When connecting ribbon cable to A19 Module, find arrowhead on the cable plug and align with arrowhead on the board connector.*

**Reconnect W11**

1. Switch instrument to **Standby** to reconnect cable **W11** to **A5** Assembly or **A19** Module. (Refer to table on foldout in **MECHANICAL PROCEDURES** for information on reconnecting cable **W11** to **A5J8**.)
2. Return to foldout.



---

**A19 THEORY OF OPERATION**

---

**3N-4. A19 DOUBLER MODULE****COMMENT**

*It is not to essential to understand the internal operation of a module to make an on-site repair.*

The **A19 Doubler Module** is included in the **HP 8642B** only. This module provides both frequency doubling and level attenuation for the RF output signal. Two attenuator assemblies connected in series provide level attenuation to **-140 dBm**. The second attenuator assembly includes reverse power protection circuitry for the **RF Output** port. The RF switch, attenuator and reverse power control signals are sent to the **A19 Module** from the **A17 Module** in the **Power Supply Section**.

The RF Signal from the **A14 Module** is switched between a through path (for output frequencies from **100 kHz** to **1057 MHz**) and a frequency doubler path. In the doubler frequency band (**1058** to **2115 MHz**) the RF signal is amplitude modulated by the **A19 Module** using the audio signal sent from the **A2 Modulation Module**.

The RF output signal from the **A19 Module** is routed directly to the **HP 8642B's RF Output** port.

See the **A19 MODULE SIMPLIFIED BLOCK DIAGRAM** for further understanding of the **A19 Module's** internal operation.

---

## REPLACING A MODULE

---

### 4-1. INTRODUCTION

This section contains information for performing a module replacement on-site. Module replacement is the last step in the on-site repair process and should only be performed after the replacement module has been tested using the module substitution techniques described in **Module Level Diagnostics** (refer to the section tabbed for the module you are replacing to find the module substitution procedure). For further information on using the on-site diagnostics, refer to the **INTRODUCTION** section of the manual.

#### Replacement Instructions

1. **The last page in this section is a foldout and should be pulled out now.**
2. Find **MODULE REPLACEMENT** on the foldout.
3. Use the Task Sequence Diagram, shown under **MODULE REPLACEMENT** to direct you through the testing process. Each Task Arrow shown in the diagram indicates a task title and task number. The tasks are numbered according to the order in which they are arranged in this section. Turn to the task indicated and complete the procedure.
4. After completing the procedure, return to the Task Sequence Diagram on the foldout and determine the next task to be performed.
5. Begin now by performing the first task shown on the diagram.

---

**REPLACING A MODULE**

---

Type:	Mechanical Procedure	<b>RM.01</b>
Run Time:	N/A	
Set-up Time:	Refer to Section V	

**NOTE**

*If you are replacing module A3, A4, A14, A16, or A19, and have performed the module substitution test, the module should already be installed in instrument. Check that cable connections and module retaining clips are secure and return to foldout.*

1. Replace module:
  - **MECHANICAL PROCEDURES** section provides replacement procedures for all on-site replaceable modules. Refer to table on foldout in **MECHANICAL PROCEDURES** to locate module replacement information.
2. Reconnect Cables:
  - Connect cable to replacement module (see **INSTRUMENT WIRING DIAGRAM** on foldout for cable connection and routing information).
3. Return to foldout.

---

**REPLACING A MODULE**

---

Type:	Cal Data Transfer	
Run Time:	2 min.	
Set-up Time:	4 min.	

**NOTE**

*The following modules do not require Calibration Data: A1, A4, A7, A8, and A13. If you are replacing one of these modules, this procedure does not apply; return to foldout now.*

**Set-Up Cal Board**

1. Remove **A20 Calibration Module**, provided with replacement module, from On-Site Service Kit.
2. Switch **[POWER]** to Standby and connect Cal Board to **A3 Module** at **A3J3**. (See **INSTRUMENT WIRING DIAGRAM** on foldout for **A3J3** location.)

**NOTE**

*If you are replacing module **A3, A11, or A12** and performed a **Calibration Data Down-Load** as part of the substitution procedure, proceed directly to **Up-Load Cal Data, step 8**, of this procedure.*

3. Switch instrument **ON**.

**Down-Load Cal Data****COMMENT**

*This portion of the procedure down-loads the calibration data for the replacement module into the instrument. This data replaces the cal data for the defective module.*

**CAUTION**

*Sliding switch **A3S2** to its rear position unprotects the **HP 8642 EEPROMs**. To prevent any damage to the instrument's memory, carefully perform the steps in this procedure in the order which they are given.*

---

---

**REPLACING A MODULE**

---

**COMMENT**

*If you get off track, return A3S2 to its protect position, switch the instrument to Standby then back ON, and begin again at step 4.*

4. When "100.000000MZ -140.0DM appears:
  - Slide A3S2 back toward rear of instrument. (See **INSTRUMENT WIRING DIAGRAM** on foldout to locate A3S2.)
5. **SHIFT** **SPCL** **3** **7** **3** **HZ**
6. Enter Cal Data Select Keys, shown on foldout in **CAL DATA TRANSFER TABLE**, for module being replaced. **HZ**
7. When "TRANSFER VERIFIED U613" appears:
  - Slide A3S2 toward front of instrument to protect instrument's memory.

**Up-Load Cal Data**

This portion of the procedure creates a new backup A20 Calibration Module for the instrument by up-loading all of the instrument's current Cal Data onto the replacement A20 Module.

CAUTION

*Moving switch A20S1 on the A20 Module down to its **CHANGE** position unprotects the A20 EEPROMs. To prevent any damage to the A20 EEPROMs, carefully perform the steps in this procedure in the order which they are given.*

**COMMENT**

*If you get off track, return A20S1 to its **PROTECTED** position, switch the instrument to Standby then back ON, and begin again at step 8.*

8. Move A20S1 down to its **CHANGE** position.
  9. **SHIFT** **SPCL** **3** **7** **4** **HZ**  
(To up-load entire instrument's cal data)
-

---

**REPLACING A MODULE**

---

10. When **"08 SECTIONS STORED .U610"** (HP 8642A) or **"10 SECTIONS STORED .U610"** (HP 8642B) appears:
  - Move **A20S1** up to its **PROTECTED** position.
  - **[HZ]** to end routine.
11. Switch **[POWER]** to Standby.
12. Remove old back-up **CALIBRATION MODULE A20** from Rear Panel of instrument. (Refer to table on foldout in **MECHANICAL PROCEDURES** to locate removal instructions.)
13. Put **A20 Module** from rear of instrument in On-Site Service Kit with defective module. (Place red defective marker in slot with module.)
14. Remove new back-up **A20 Module** from **A3J3** and store in back of instrument. (Refer to table on foldout in **MECHANICAL PROCEDURES** for location of **A20** replacement instructions.)
15. Return to foldout.

---

**REPLACING A MODULE**

---

Type:	Instrument Level	
Run Time:	Self Test	
Set-up Time:	3 min 30 sec 1 min	

Over-all operation of module and instrument is tested by running the Instrument Level Self Test (ILST).

**NOTE**

*If the ILST did not detect a failure when run as part of Instrument Level Diagnostics, repeat test(s) which did indicate a failing condition.*

**Run ILST**

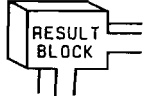
1. **INSTR PRESET** **SHIFT**  
(Hold shift key until "100.000000MZ -140.0DM" appears, to override 20 second reset test.
2. **SHIFT** **SPCL** **3** **3** **0** **HZ**.
3. When "WAITING FOR SET-UP 1 .V24" appears:
  - Connect BNC Tee connector, from On-Site Service Kit, to "FM/ΦM INPUT". (See foldout in INSTRUMENT LEVEL DIAGNOSTICS section for set-up diagram.)
  - Connect a coax cable from Tee connector to "MOD OUTPUT".
  - Connect a coax cable from Tee to "AM/PULSE INPUT"
  - **HZ** to continue.
4. When "DIAG DONE HIT MSSGS .VI" appears:
  - Use **MSSG** to scroll through messages.
  - Record any module numbers indicated.
5. Return to foldout:
  - Determine next task by comparing test results to conditions shown in each  for **CONFIRM REPAIR**.

---

**REPLACING A MODULE**

---

Type:	Module Exchange	<b>RM.04</b>
Run Time:	N/A	
Set-up Time:	N/A	

The on-site service process is not finished until all defective parts contained in the On-Site Service Kit have been replaced or repaired.

1. Flag defective module(s):
  - Red "defective" cards have been placed inside On-Site Service Kit. Place one in slot with defective module so that it is visible when kit is open.
2. Make immediate arrangements for defective part(s) to be repaired and/or replaced in On-Site Service Kit. (Refer to **REPLACEABLE PARTS** for ordering and module exchange information.)
3. Return to foldout.



---

**REPLACING A MODULE**

---

<b>Type:</b>	Mechanical Inspection	<b>RM.05</b>
<b>Run Time:</b>	3 min. 30 sec.	
<b>Set-up Time:</b>	Conditional	



1. Check each cable connection:
  - Make sure each cable connected to module is connected securely at the correct port. (See **HP 8642A/B Table of Cable Connections** on inside of Top Cover to quickly reference cable connections.)
  - Check cable connections for any other cables disconnected during testing. Check for bent pins on ribbon cable connectors.
2. Check Cal Data transfer:
  - If module required transfer of calibration data, refer to **CAL DATA TRANSFER TABLE** and verify that the correct Cal Data Select Keys were used to down-load the data.
3. Re-run confirmation test:
  - Try re-running same confirmation test(s).
4. Return to foldout:
  - Determine next task by comparing test results to conditions shown in each

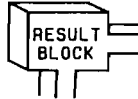

for **CHECK SET-UP**.

---

**REPLACING A MODULE**

---

<b>Type:</b>	Module Identification	<b>RM.06</b>
<b>Run Time:</b>	N/A	
<b>Set-up Time:</b>	N/A	

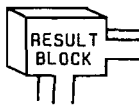
1. Specify Failure:
  - Do the failure conditions (messages, if internal diagnostics are being used) indicate the same module is still failing?
  - Are the failure conditions identical to those displayed by the original module?
2. Return to foldout:
  - Determine next task by comparing test results to conditions shown in each  for **SPECIFY FAILURE**.

---

**REPLACING A MODULE**

---

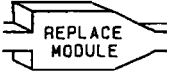
<b>Type:</b>	Module Replacement	<b>RM.07</b> 
<b>Run Time:</b>	Conditional	
<b>Set-up Time:</b>	Conditional	

This procedure replaces the **original** module in instrument for further testing.

1. Replace instrument's module in instrument:
  - Refer to table on foldout in **MECHANICAL PROCEDURES** for location of module replacement instructions.
  - Replace substitute module in On-Site Service Kit.
2. Transfer Cal data:
  - If cal data for the substitute module has been down-loaded to instrument, proceed with step 3; otherwise, return to foldout now.
3. Switch **POWER** to Standby.
4. Remove instrument's **A20 Calibration Module** from On-Site Service Kit and connect it to **A3 Module** at **A3J3**.
5. Switch instrument **ON**.

#### Down-Load Cal Data

#### COMMENT

*This portion of the procedure down-loads the calibration data for the entire instrument. This data replaces the cal data in the instrument for the substitute module.*

#### CAUTION

*Sliding switch **A3S2** to its rear position unprotects the HP 8642 EEPROMs. To prevent any damage to the HP 8642 memory, carefully perform the steps in this procedure in the order which they are given.*

#### COMMENT

*If you get off track, return **A3S2** to its protect position, switch the instrument to Standby then back **ON**, and begin again at step 6.*

---

---

**REPLACING A MODULE**

---

6. When "100.000000MZ -140.0DM" appears:
  - Slide A3S2 back toward rear of instrument. (See INSTRUMENT WIRING DIAGRAM on foldout to locate A3S2.)
7.
8. When "TRANSFER VERIFIED .U613" appears:
  - Slide A3S2 toward front of instrument to protect instrument's memory.
  - to end routine.
9. Switch  to Standby.
10. Remove A20 Module from Rear Panel of instrument and return it to On-Site Service Kit.
11. Remove instrument's A20 Module from A3J3 and return it to Rear Panel of instrument.
12. Return to foldout.



### INSTRUMENT LEVEL DIAGNOSTICS

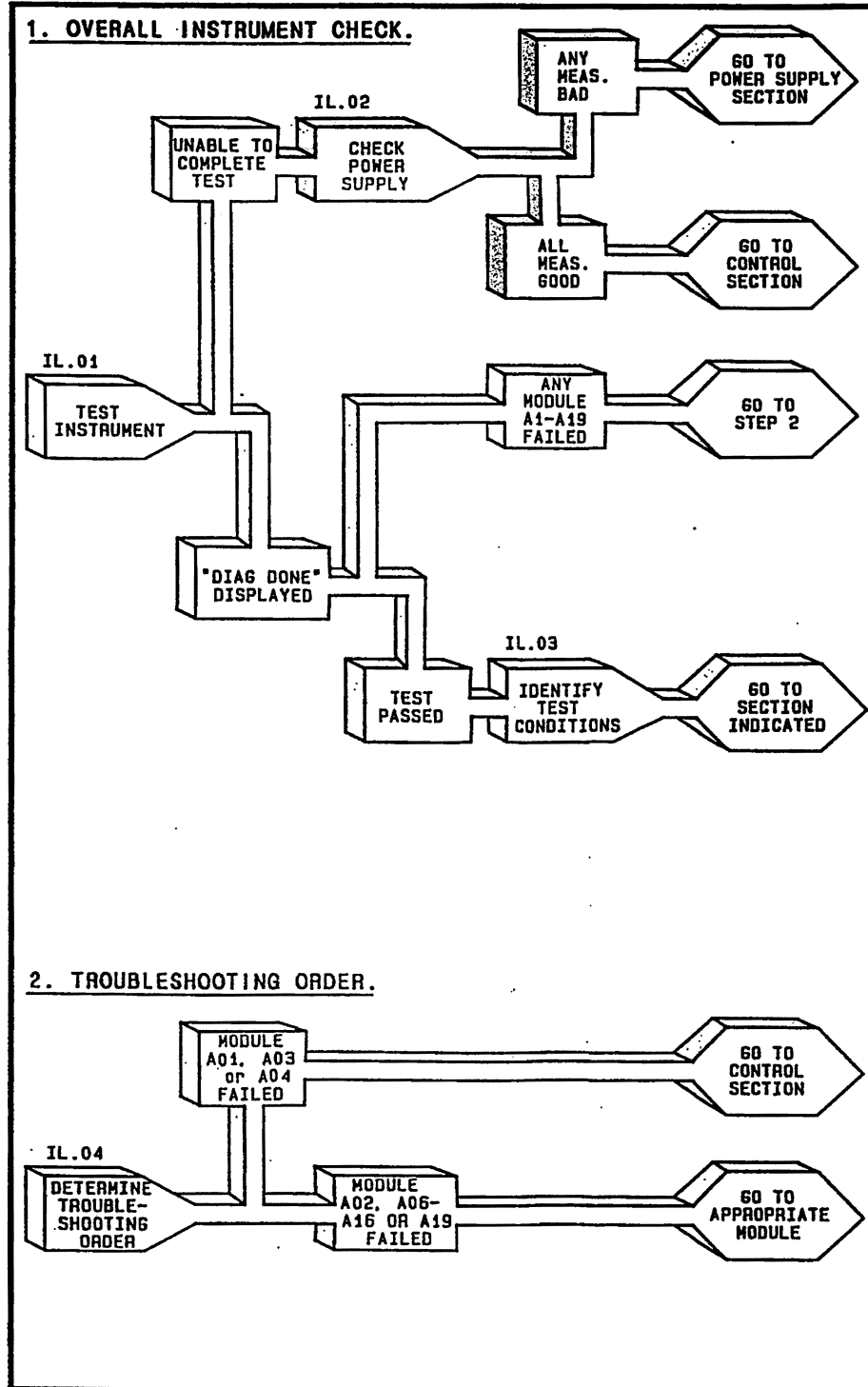

### MODULE TROUBLESHOOTING ORDER

Modules	Troubleshooting Order Number	Instrument Section
A17 Power Supply Regulators/ Attenuator Drivers Module	1	Power Supply Section
A18 Power Supply Rectifier/ Filters Module		
A01 Keyboard/LCD Display Module	2	Control Section
A03 Processor/Memory Module		
A04 Latch Module		
A06 FM Loop/Counter/ Timebase Module	3	RF Section
A02 Modulation Module	4	
A08 10 MHz High Stability Timebase Assembly (Opt. 001)	5	
A07 SAWR Loop Module	6	
A09 IF Loop Module	7	
A11 Reference Loop Module	8	
A12 Sum Loop/Divider Module	9	
A13 Output Filters/ALC Module	10	
A14 Heterodyne Module	11	
A16 Attenuator Module (8642A Only)	12	
A19 Doubler/Attenuator Module (8642B Only)		

8642 FRONT PANEL A

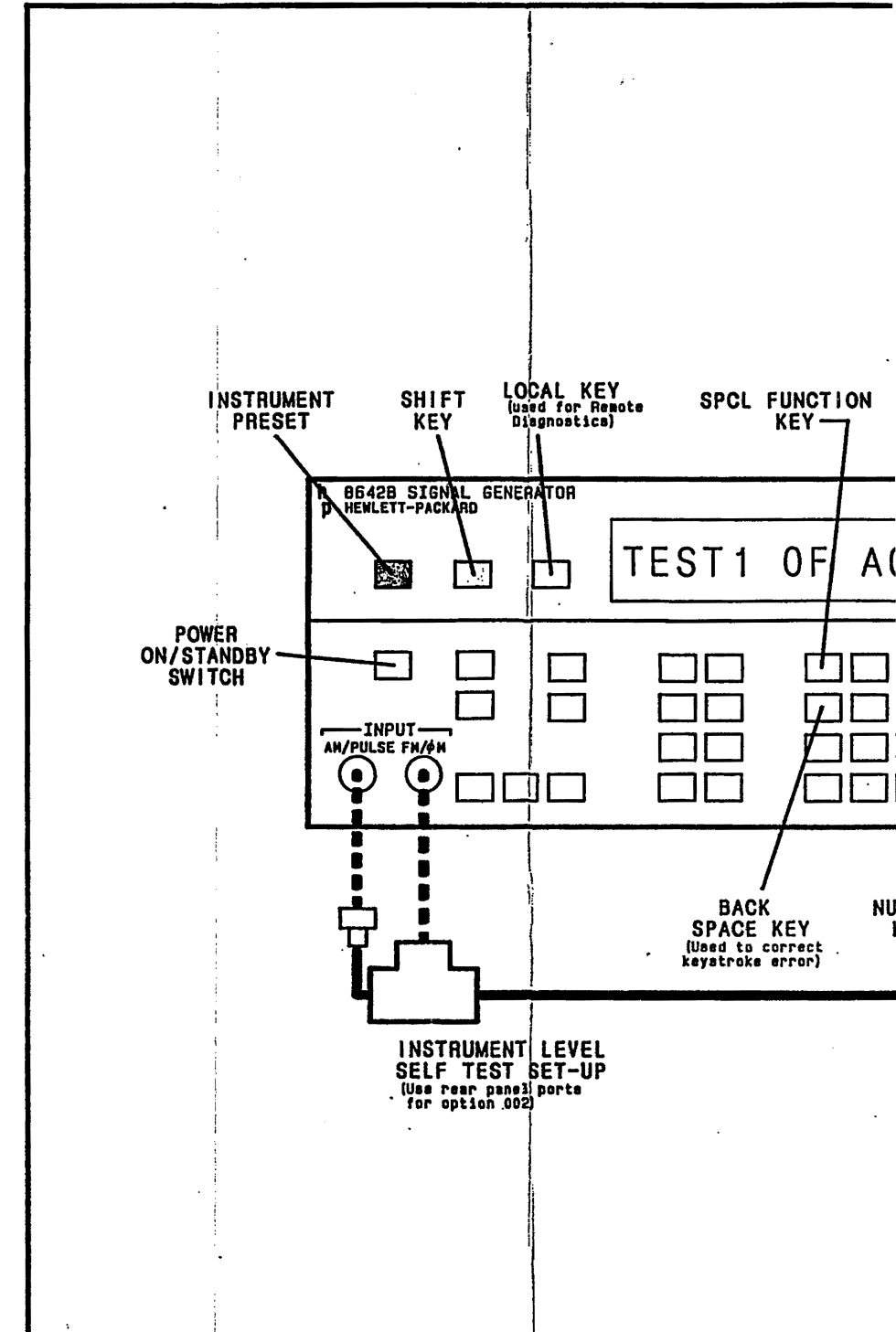

MODULE TROUBLESHOOTING ORDER

Modules	Troubleshooting Order Number	Instrument Section
A17 Power Supply Regulators/ Attenuator Drivers Module	1	Power Supply Section
A18 Power Supply Rectifier/ Filters Module		
A01 Keyboard/LCD Display Module	2	Control Section
A03 Processor/Memory Module		
A04 Latch Module		
A06 FM Loop/Counter/ Timebase Module	3	RF Section
A02 Modulation Module	4	
A08 10 MHz High Stability Timebase Assembly (Opt. 001)	5	
A07 SAWR Loop Module	6	
A09 IF Loop Module	7	
A11 Reference Loop Module	8	
A12 Sum Loop/Divider Module	9	
A13 Output Filters/ALC Module	10	
A14 Heterodyne Module	11	
A16 Attenuator Module (8642A Only)	12	
A19 Doubler/Attenuator Module (8642B Only)		

8642 FRONT PANEL AND DISPLAY

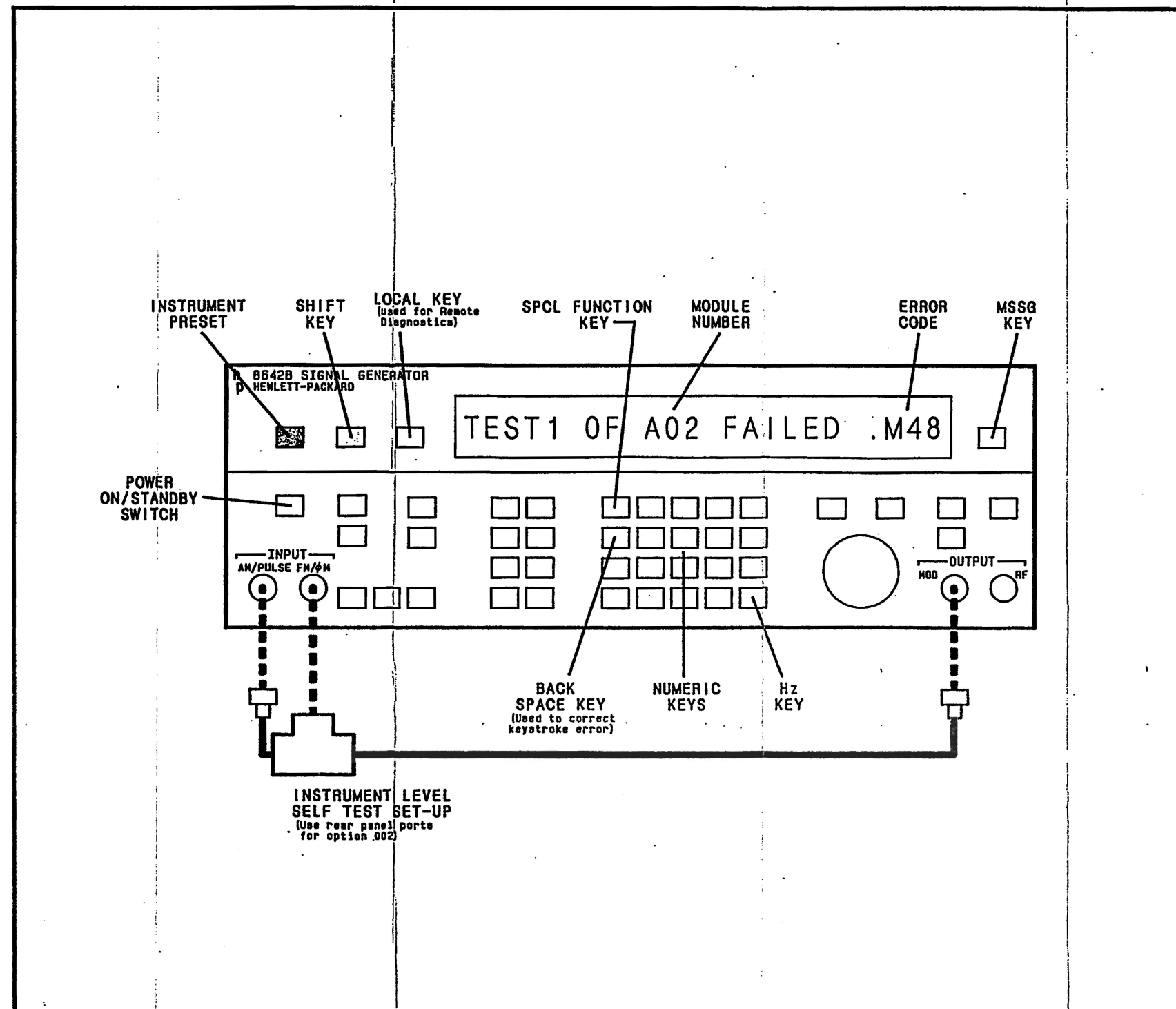
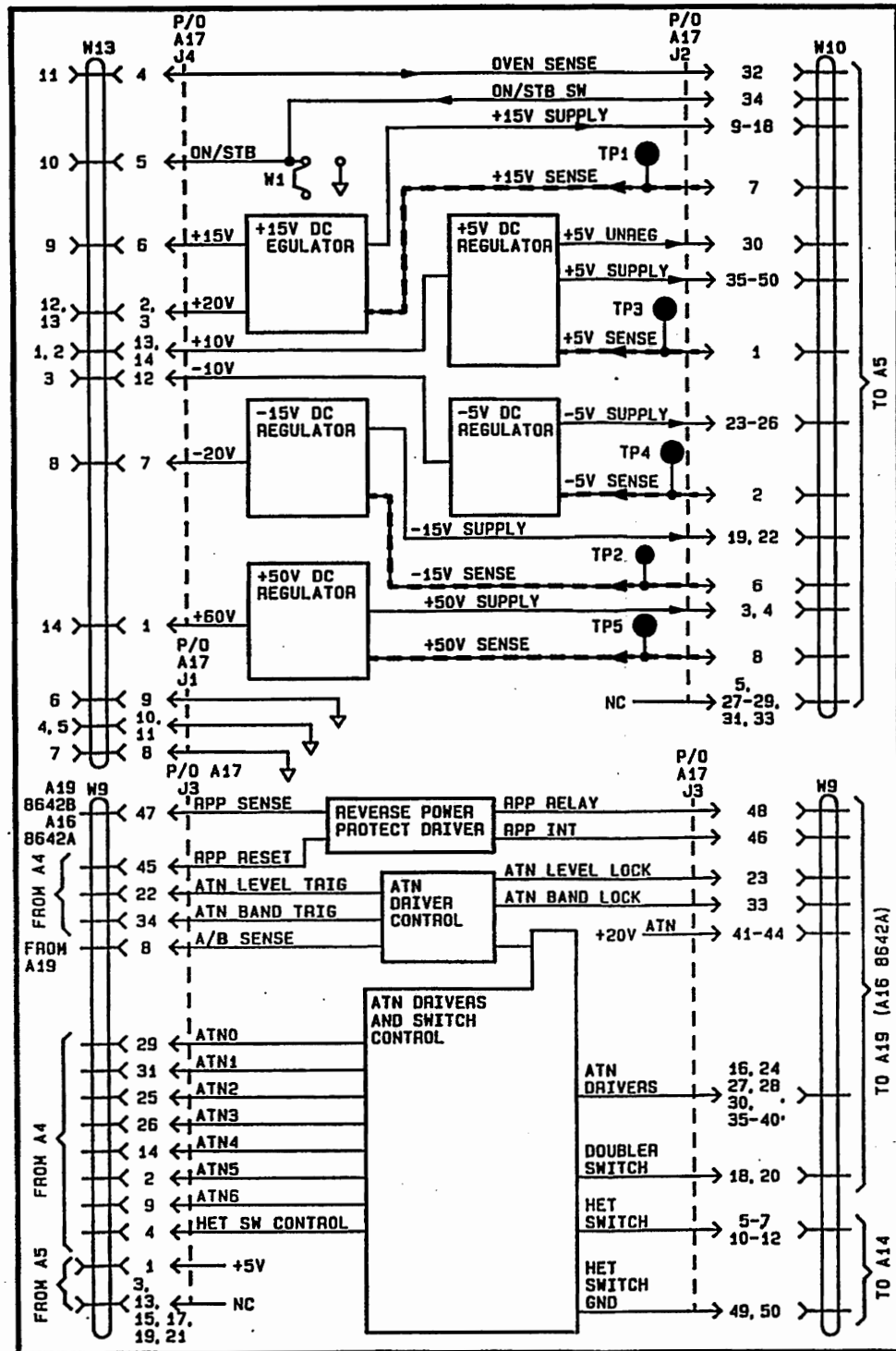

Figure 3A-100. Instrument Level Diagnostics

**A17 MODULE SIMPLIFIED BLOCK DIAGRAM**



**POWER SUPPLY DIAGNOSTICS**

**1. A18 RECTIFIERS/FILTERS CHECK.**

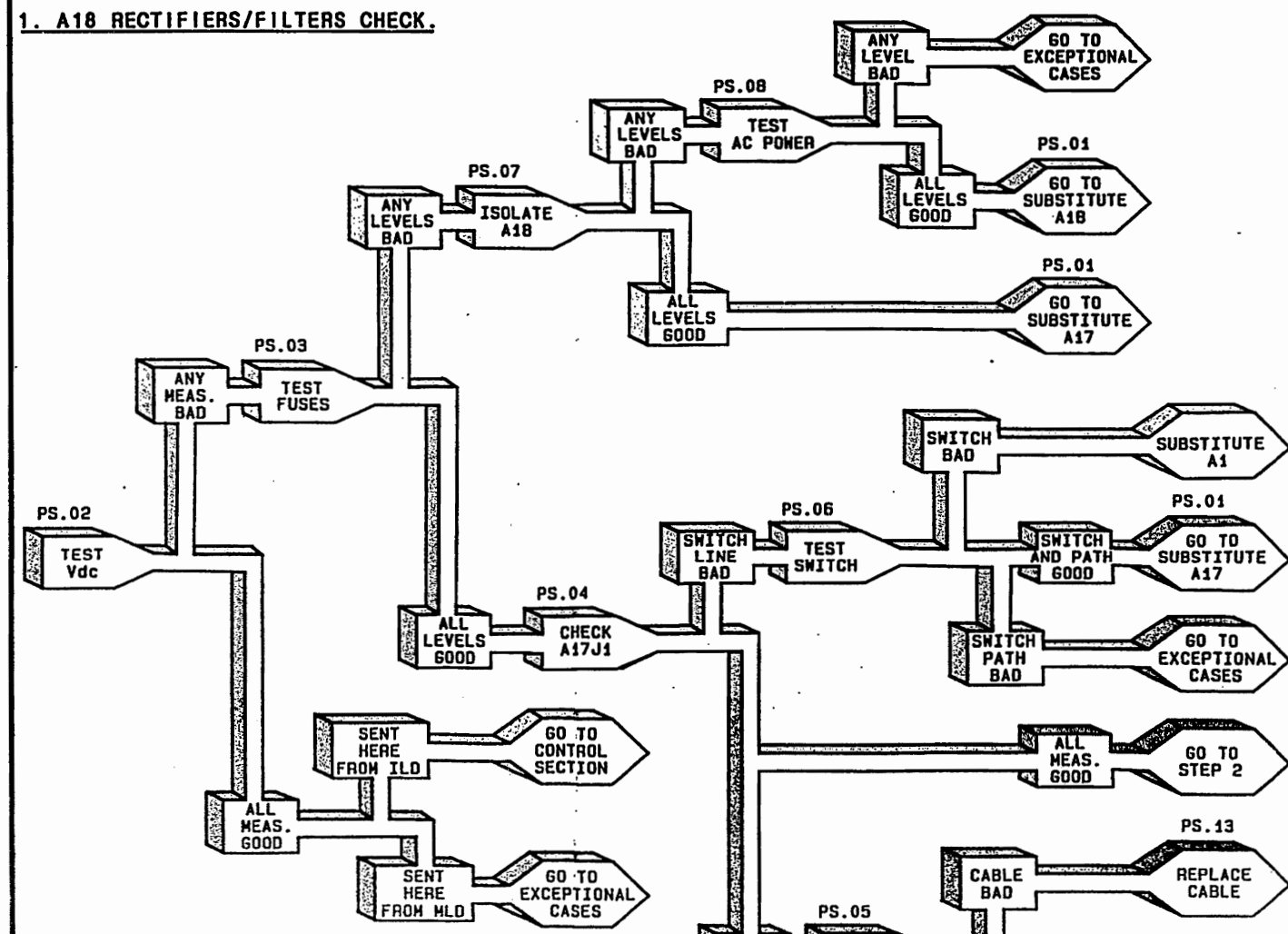

**2. A17 REGULATORS CHECK.**

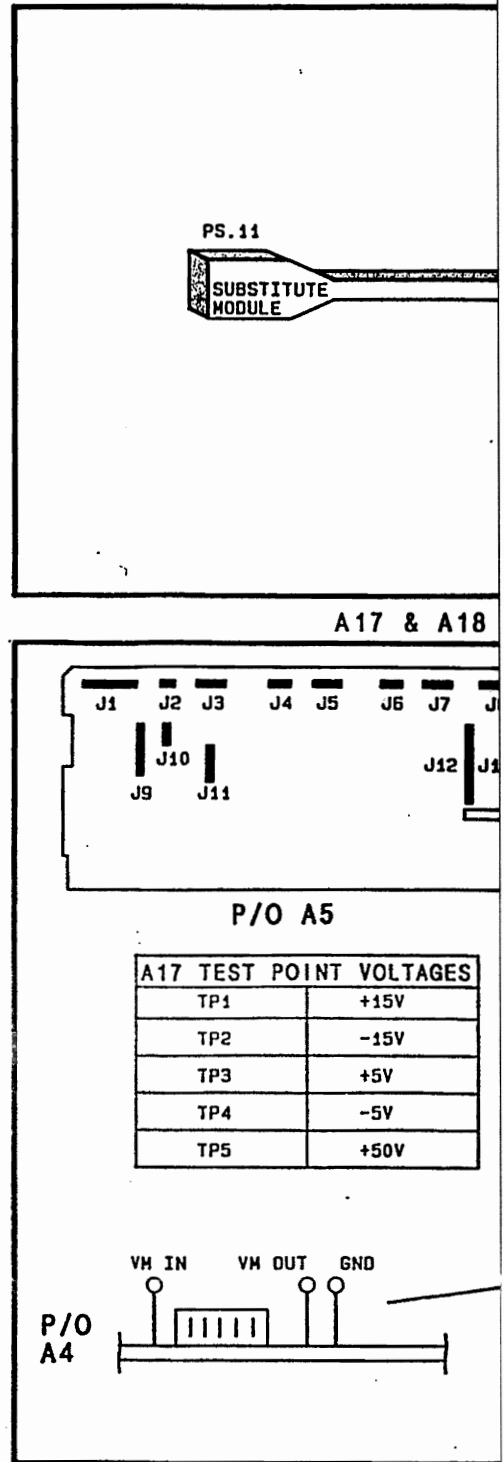
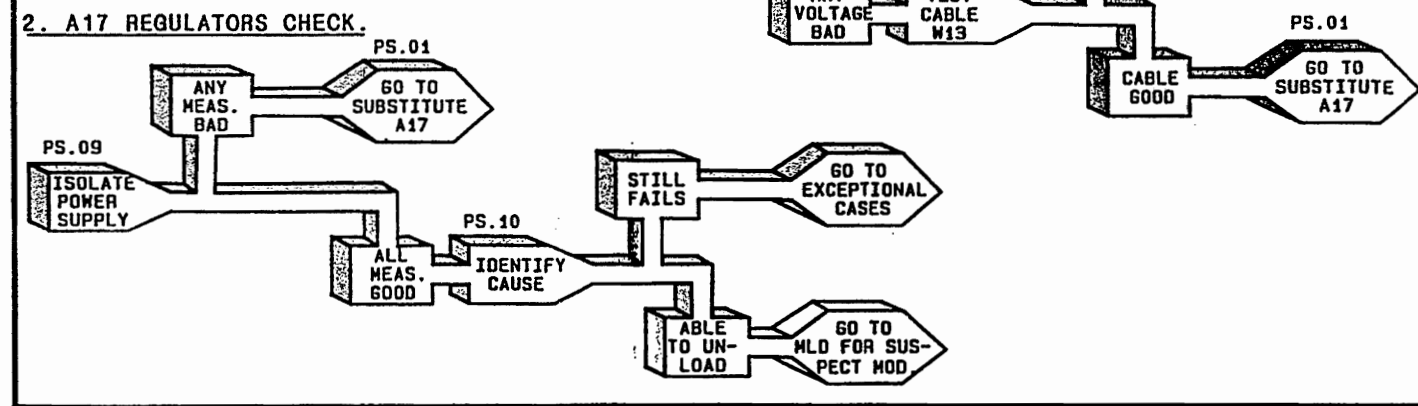
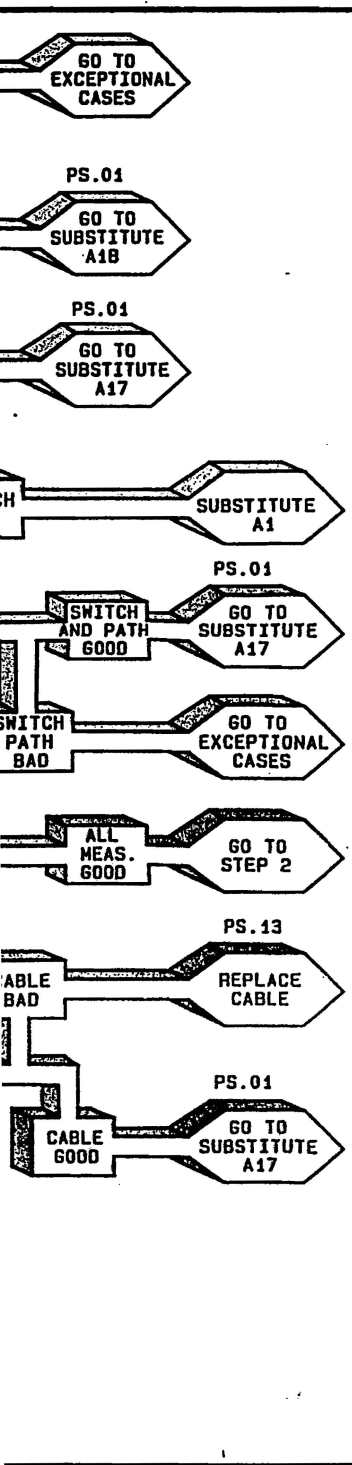
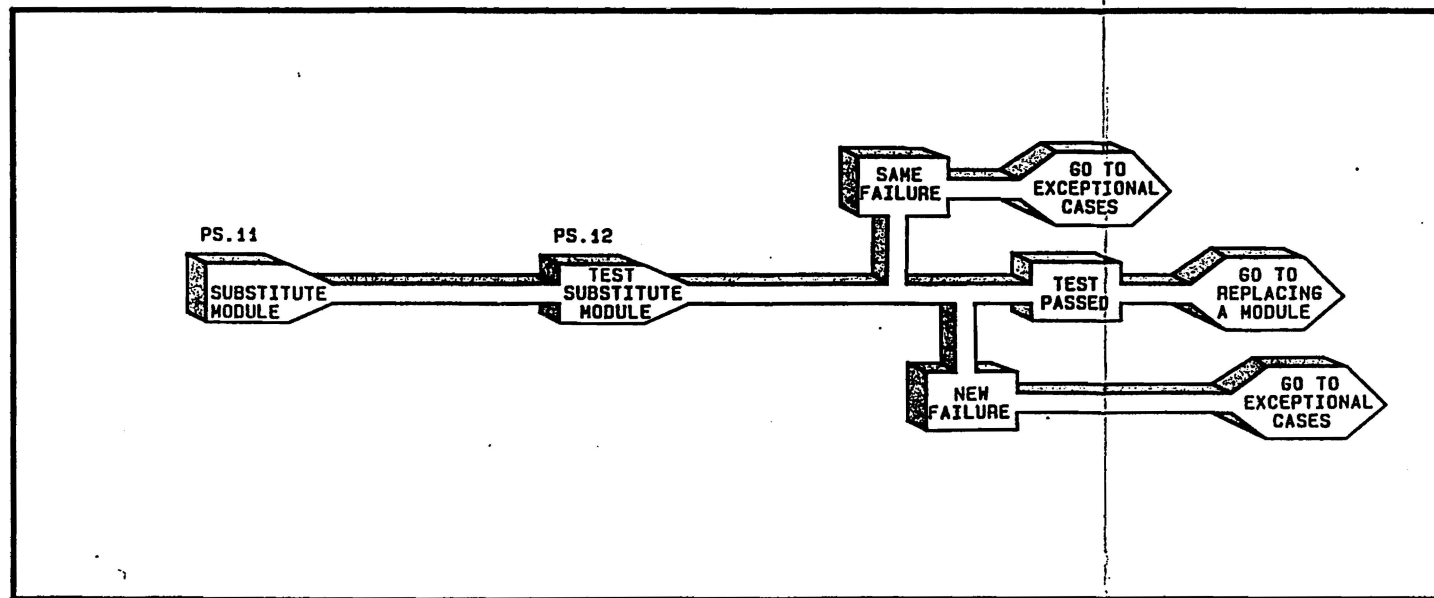

Figure 3B-100. A18





A17 & A18 MODULE SUBSTITUTION



A17 & A18 MODULES CABLE CONNECTION LOCATOR

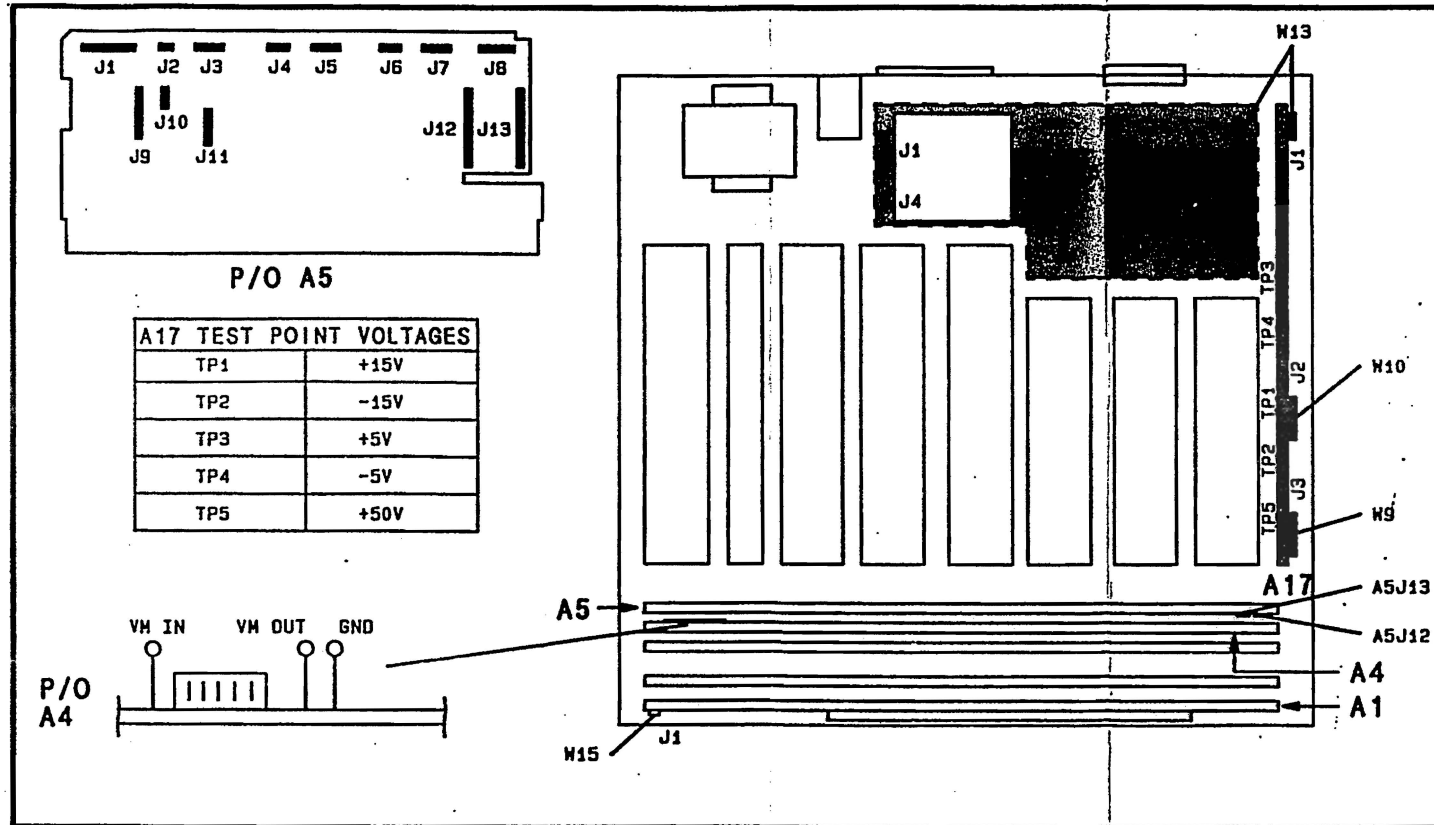

POWER SUPPLY I/O SIGNALS DIAGRAM

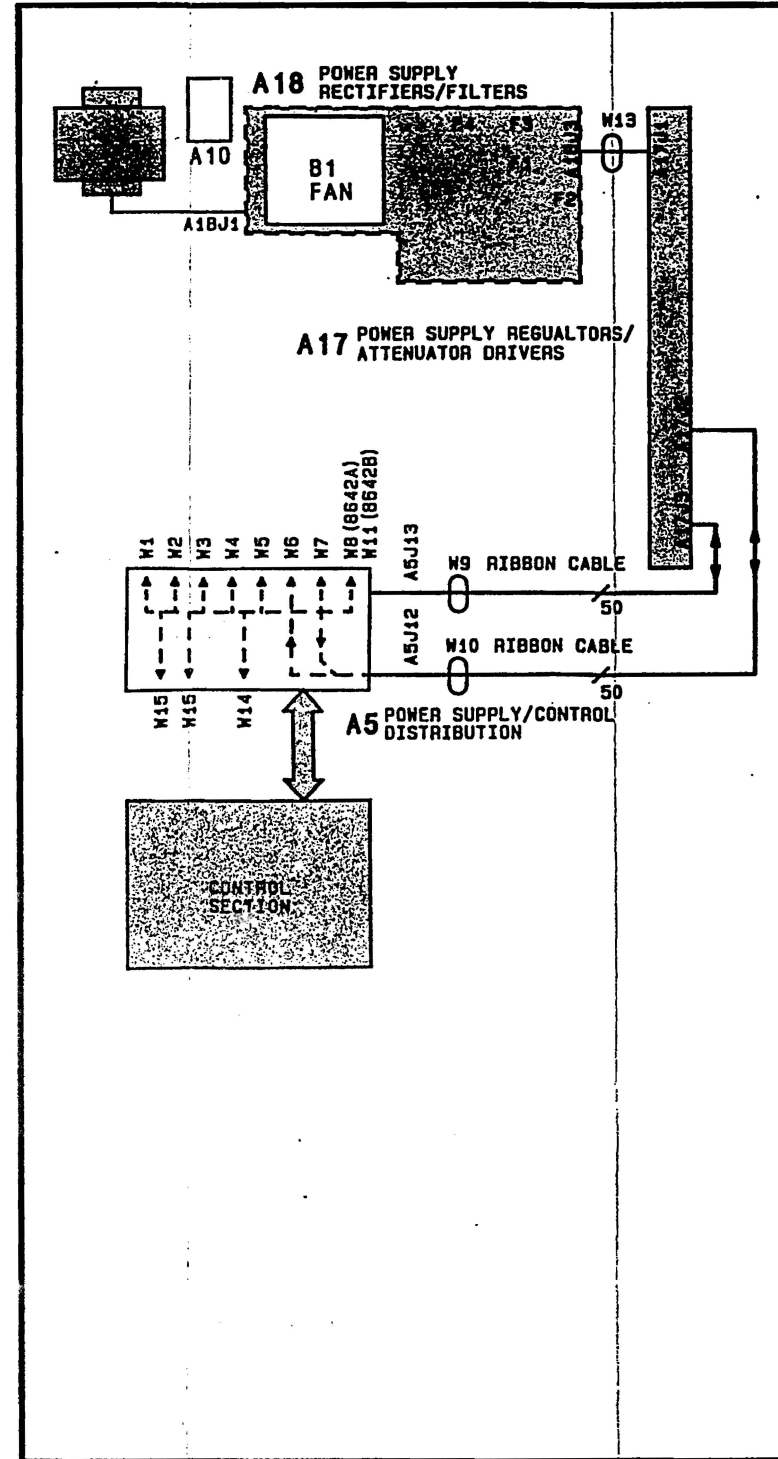
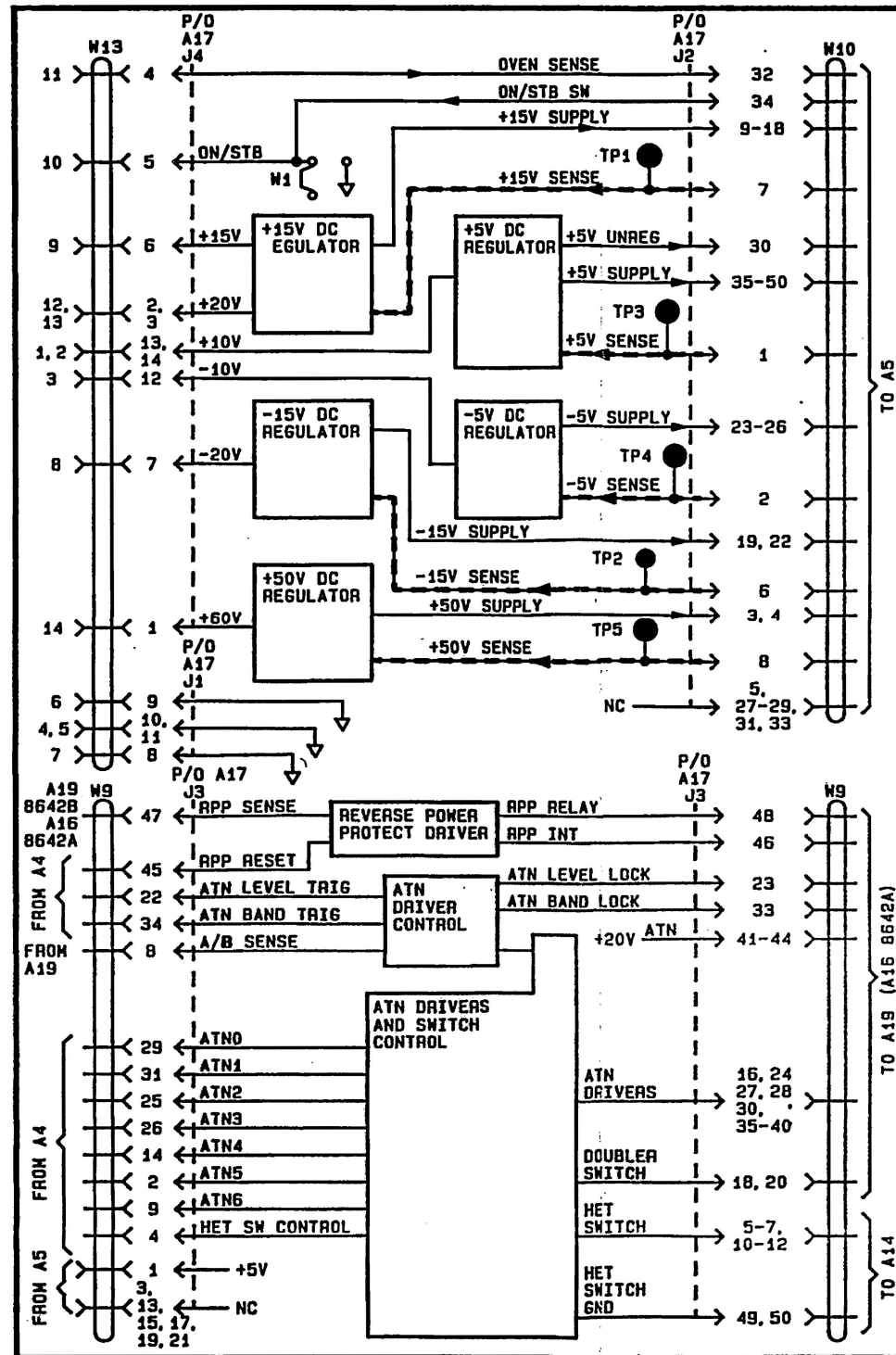
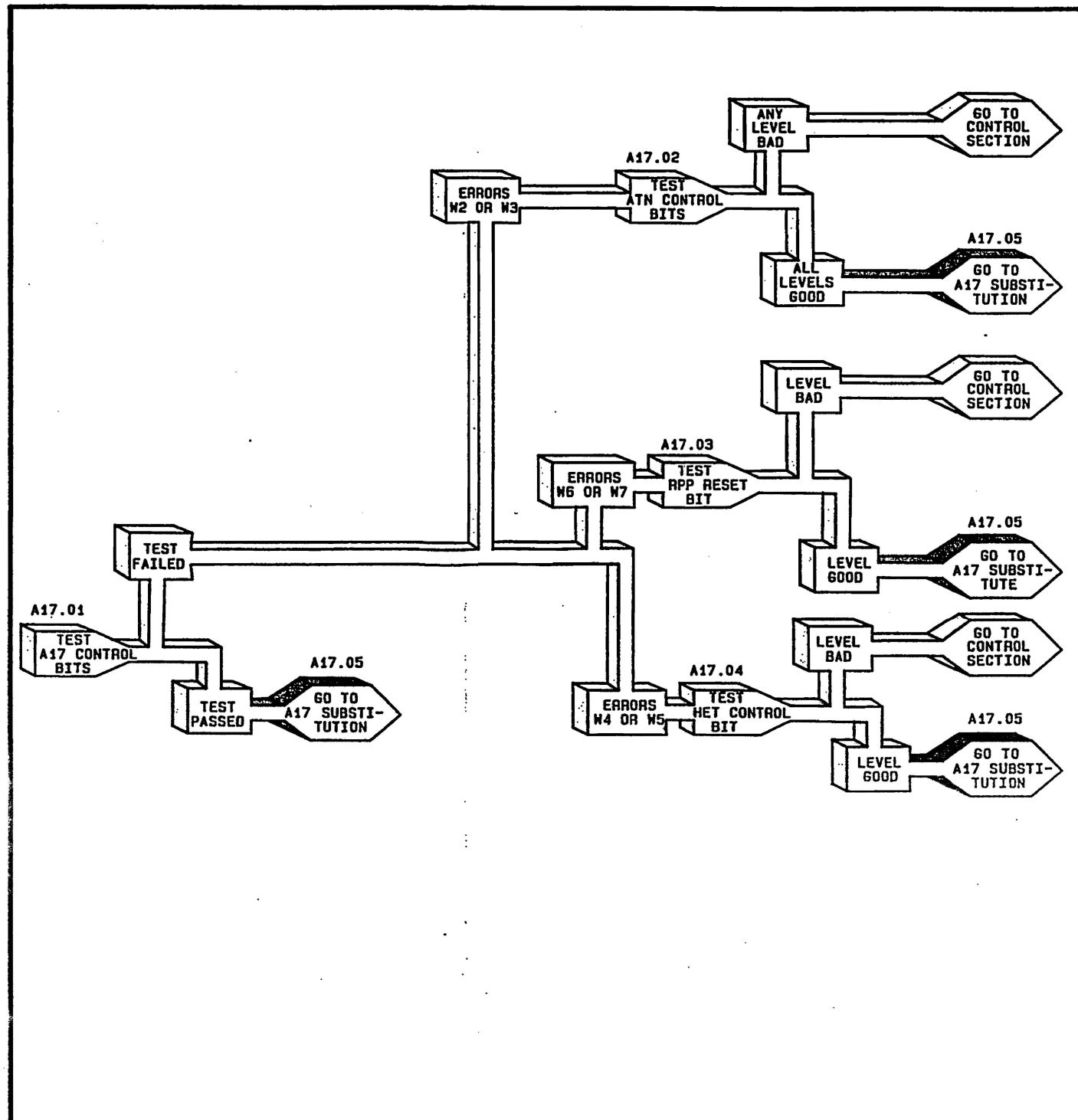

Figure 3B-100. A18 Rectifier/Filters Module and P/O A17 Power Supply Regulators/Attenuator Drivers Module Diagnostics.

A17 MODULE SIMPLIFIED BLOCK DIAGRAM



A17 INPUTS VERIFICATION



A17 TEST POINT VOLTAGES

TP	Voltage
TP1	+15V
TP2	-15V
TP3	+5V
TP4	-5V
TP5	+50V

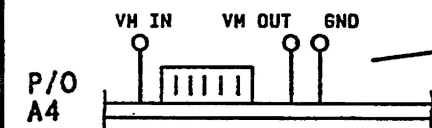

A17 MODULE SUBSTITUTION

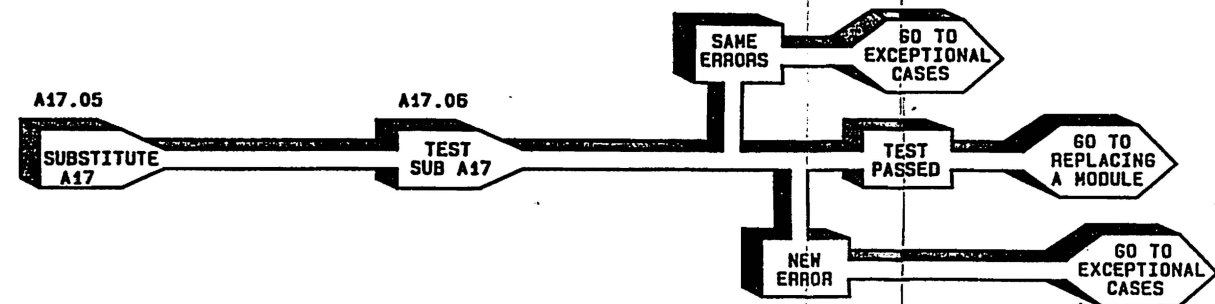

A17 MODULE CABLE CONNECTION LOCATOR

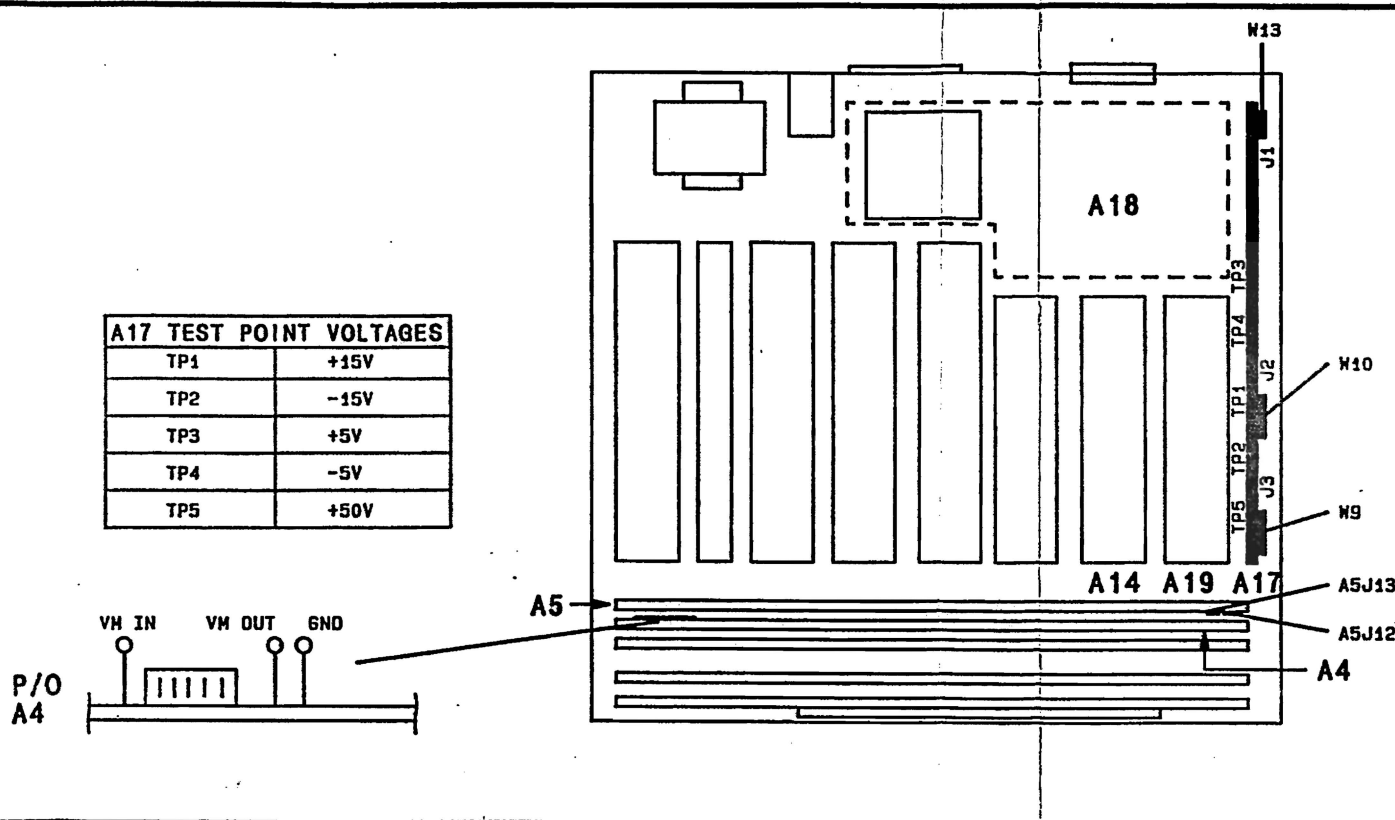

A17 MODULE I/O SIGNALS DIAGRAM

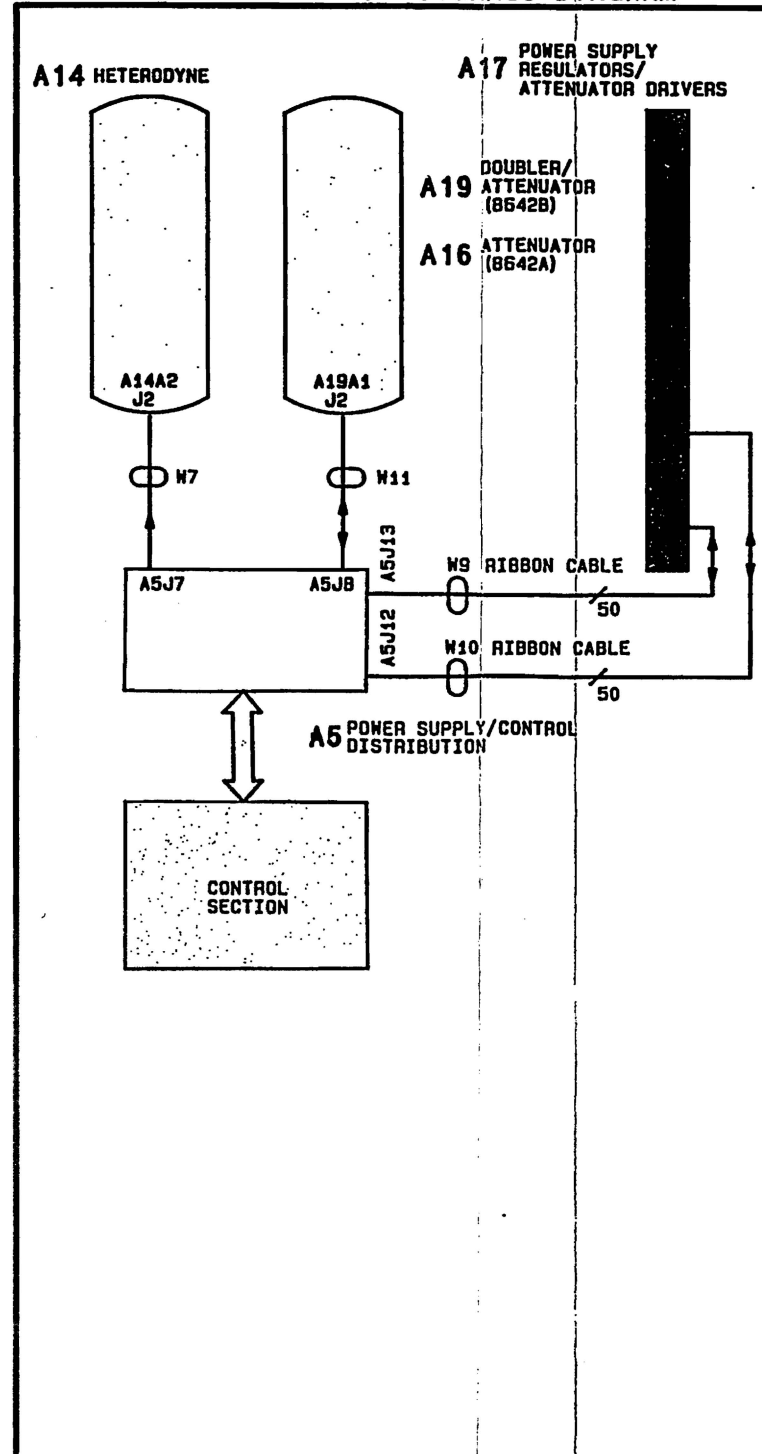
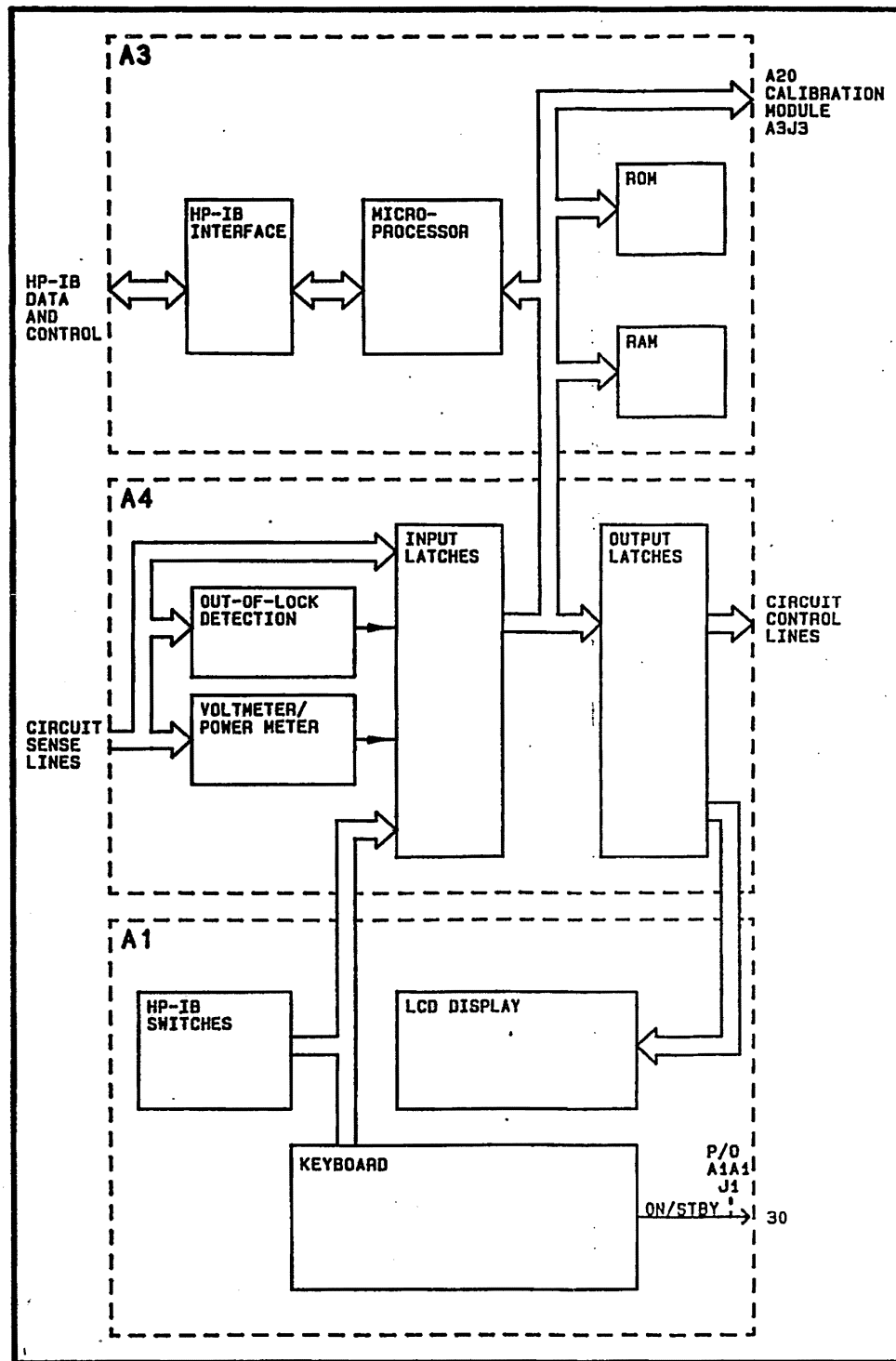
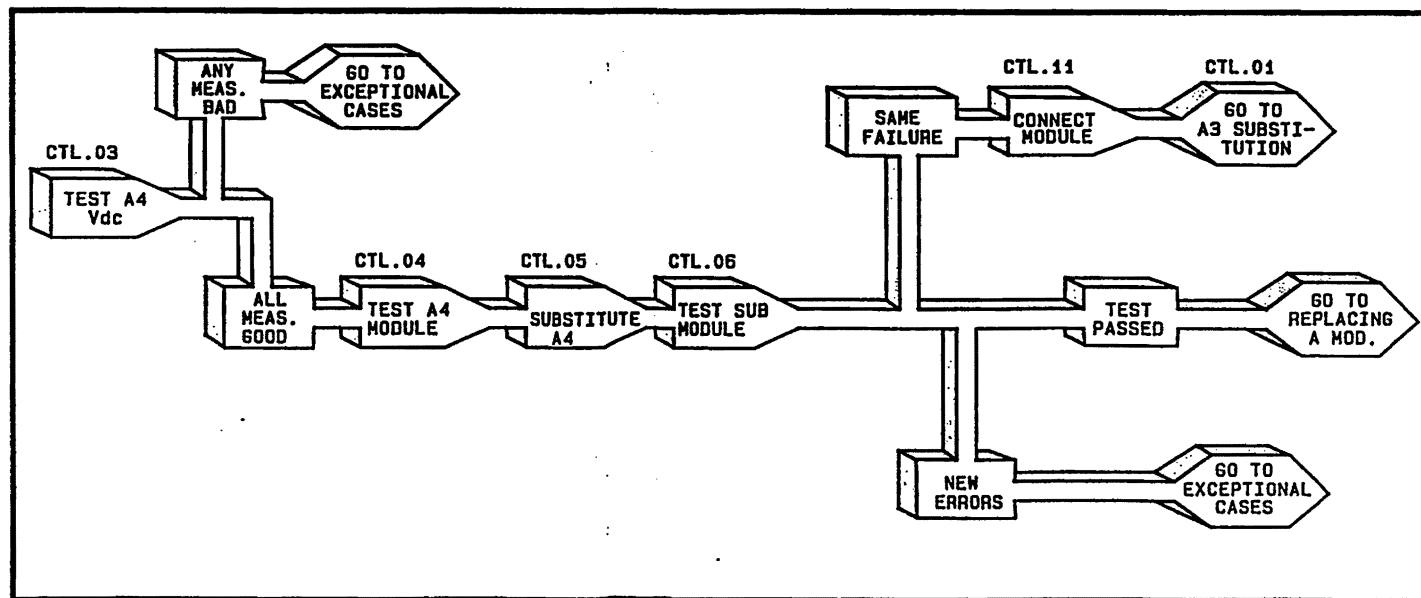

Figure 3B-200. P/O A17 Power Supply Regulators/Attenuator Drivers Module Diagnostics.

A1, A3, A4 MODULE SIMPLIFIED BLOCK DIAGRAM



A4 MODULE SUBSTITUTION



A3 MODULE SUBSTITUTION

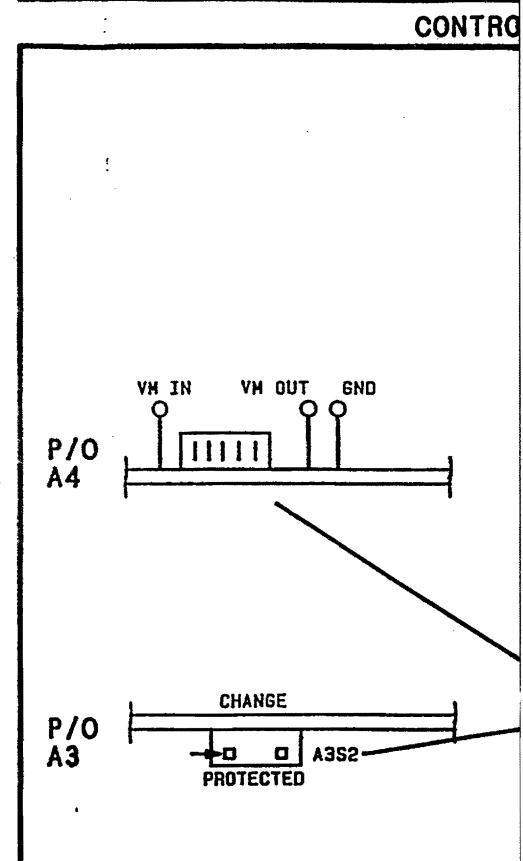
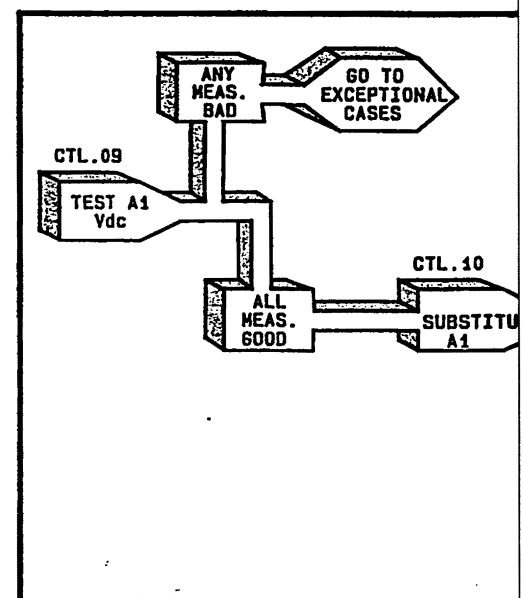
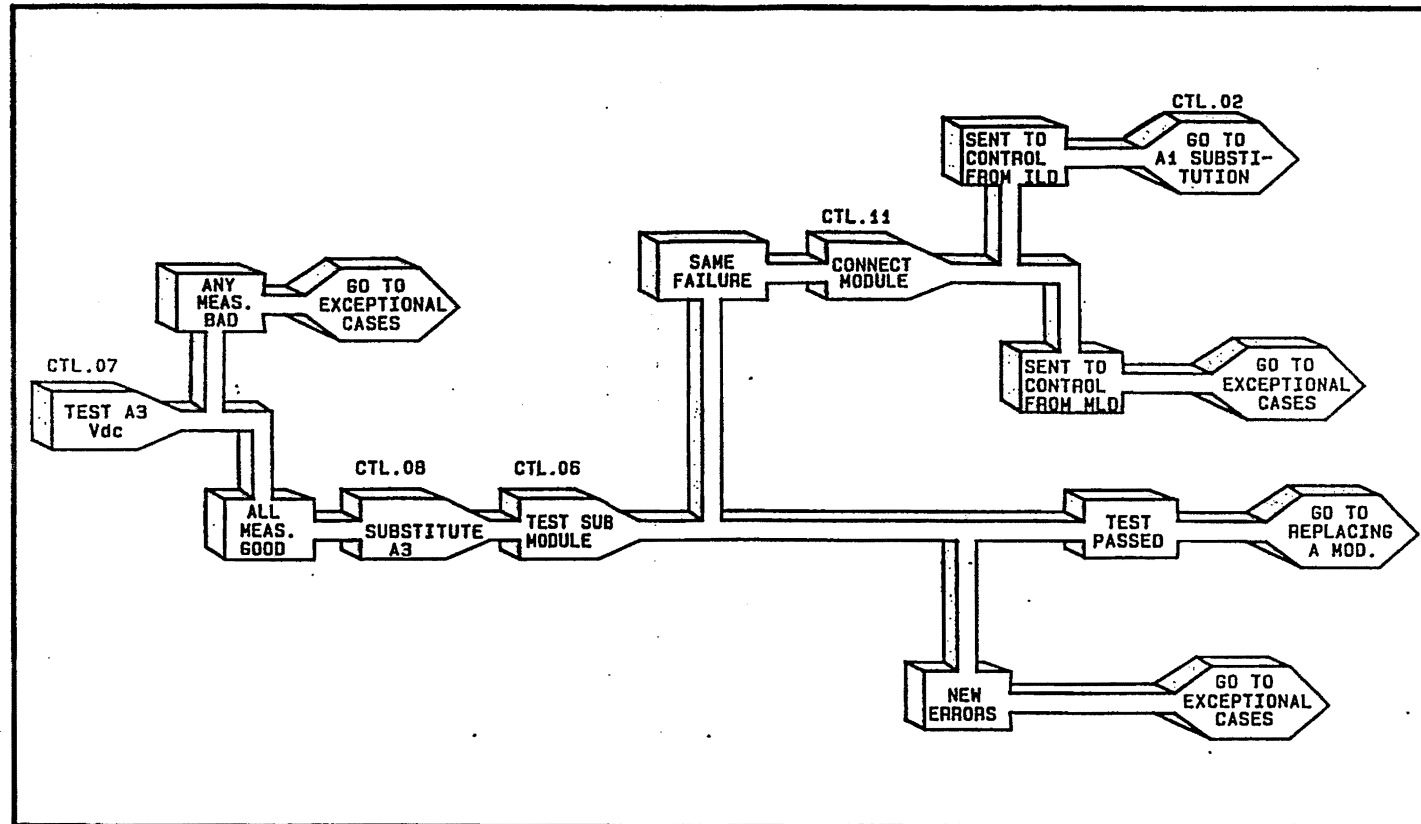

A1 MODULE SUBSTITUTION

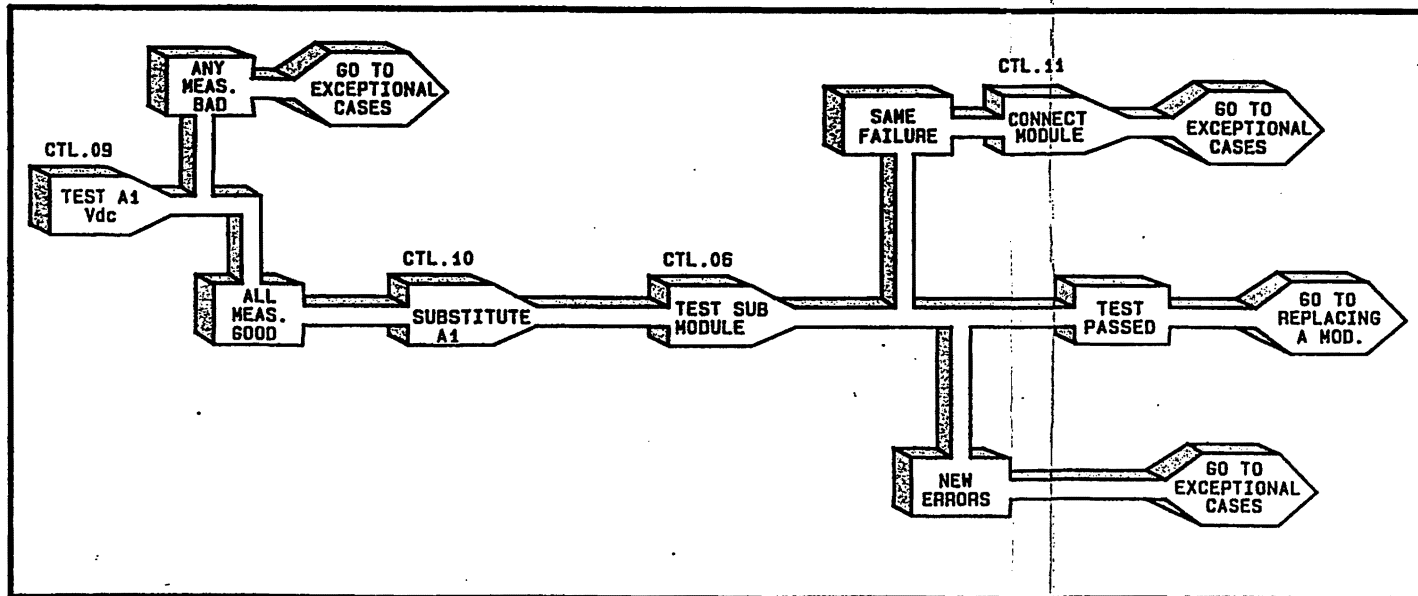

CONTROL SECTION CONNECTOR LOCATOR

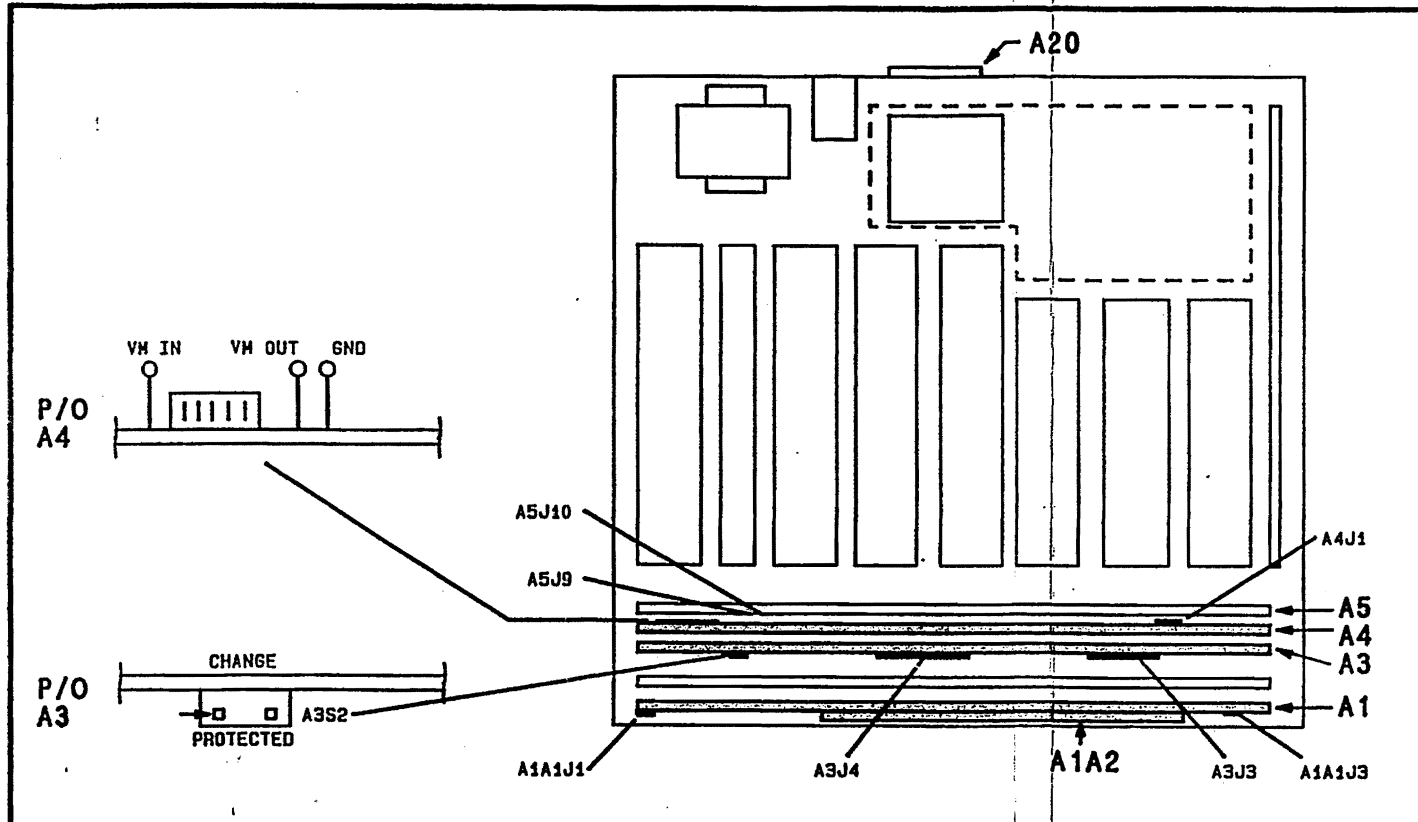

CONTROL SECTION I/O SIGNALS DIAGRAM

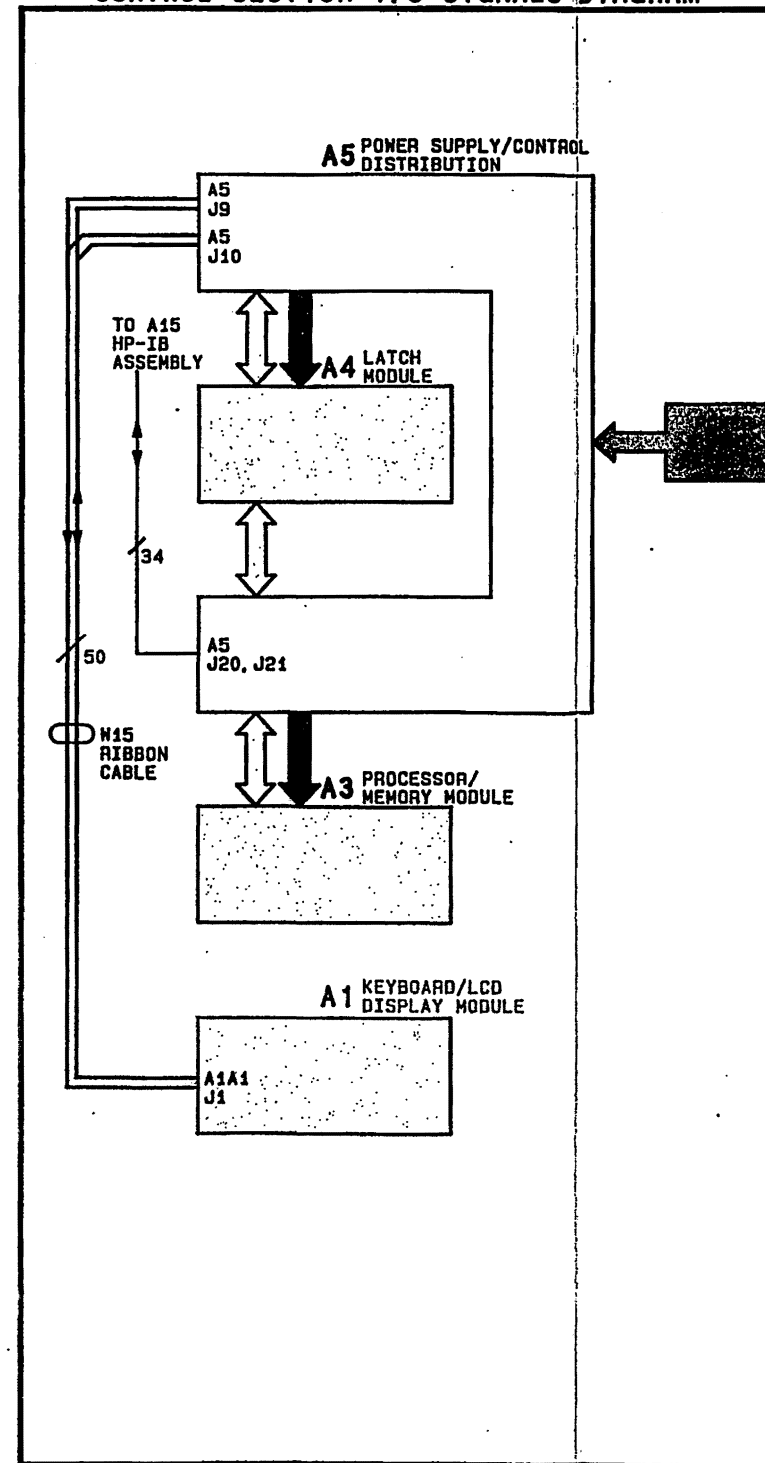
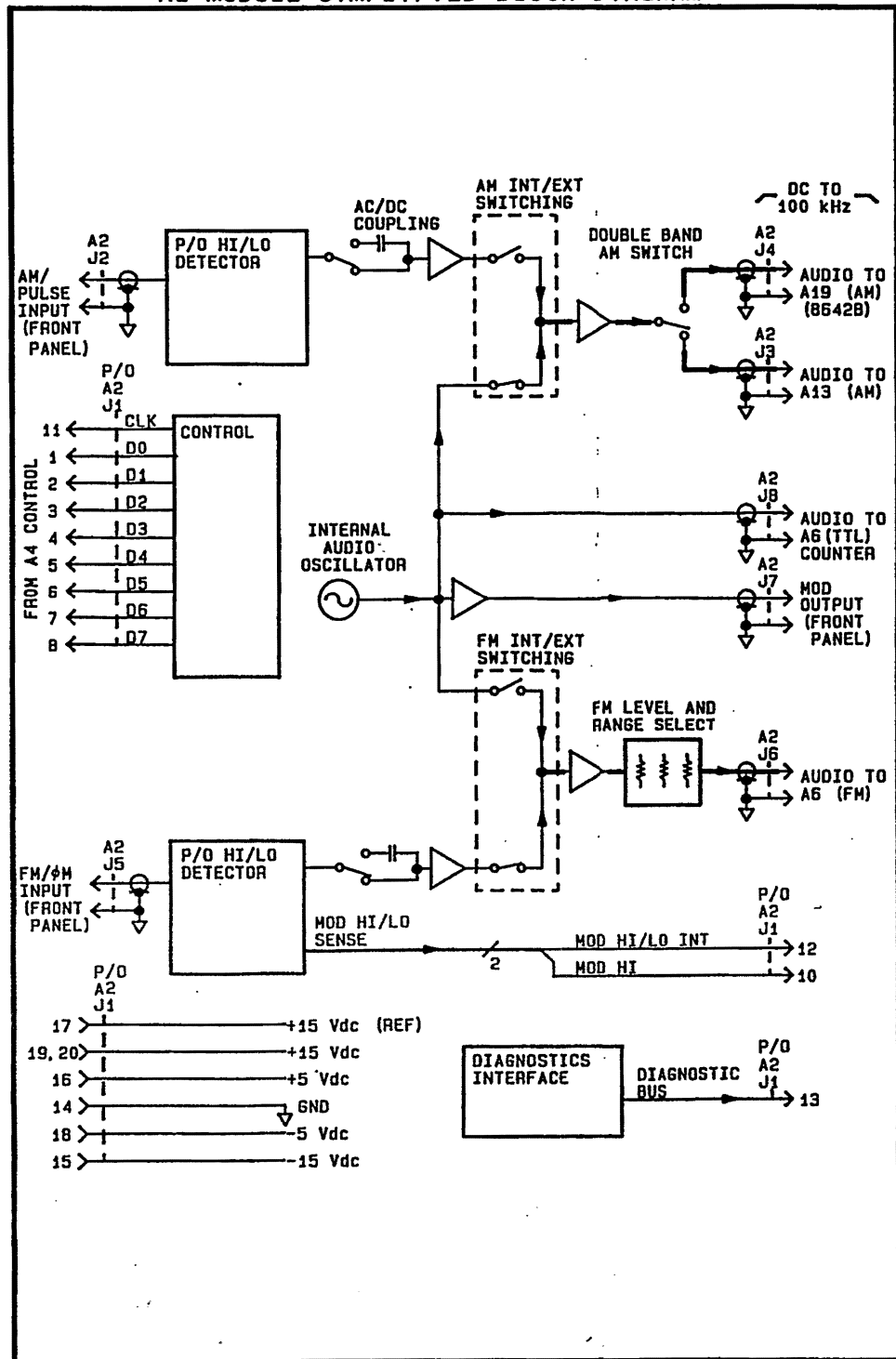
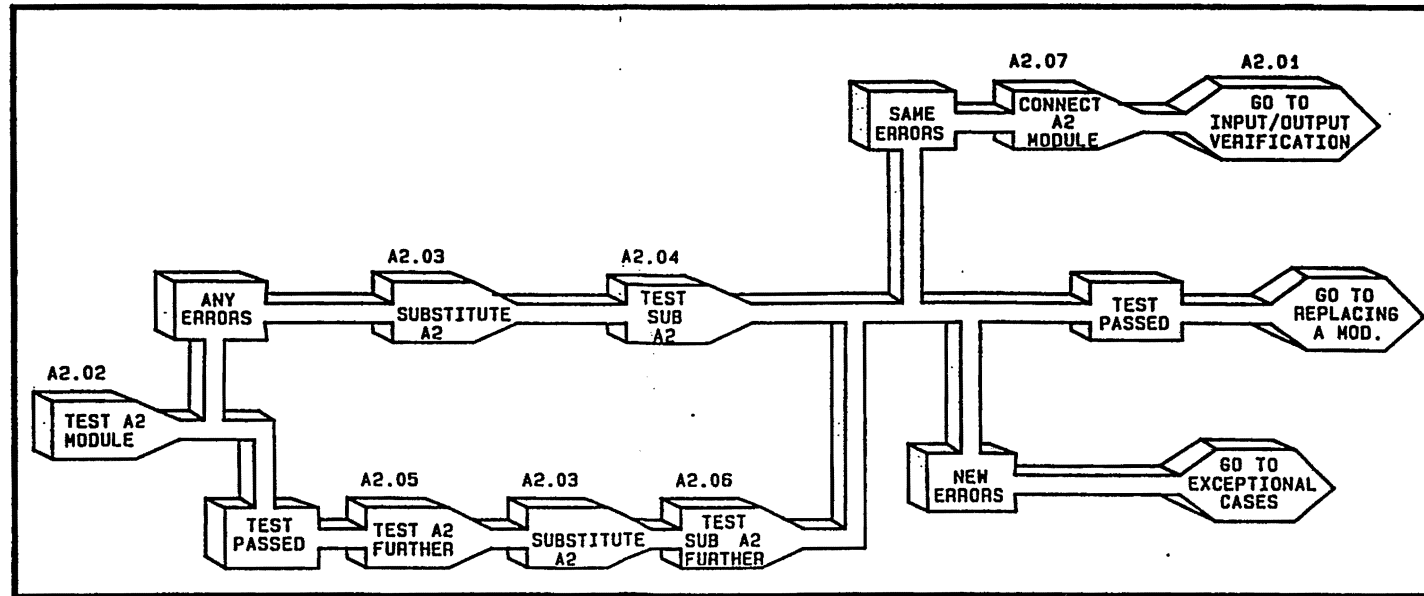

Figure 3C-100. A1,A3 AND A4 Control Section Diagnostics.

A2 MODULE SIMPLIFIED BLOCK DIAGRAM



A2 MODULE SUBSTITUTION



A2 MODULE CABLE CONNECTION LOCATOR

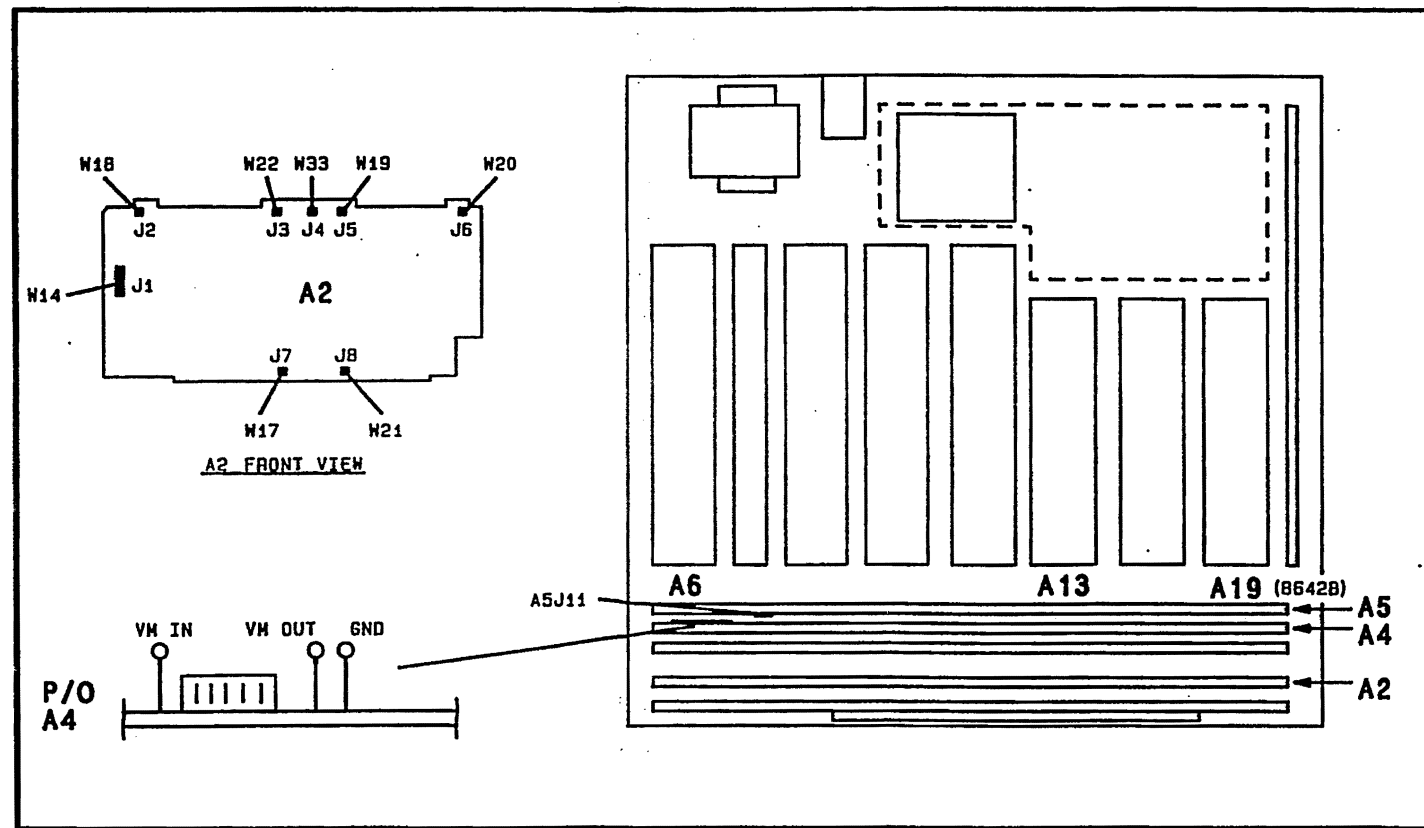

A2 INPUT

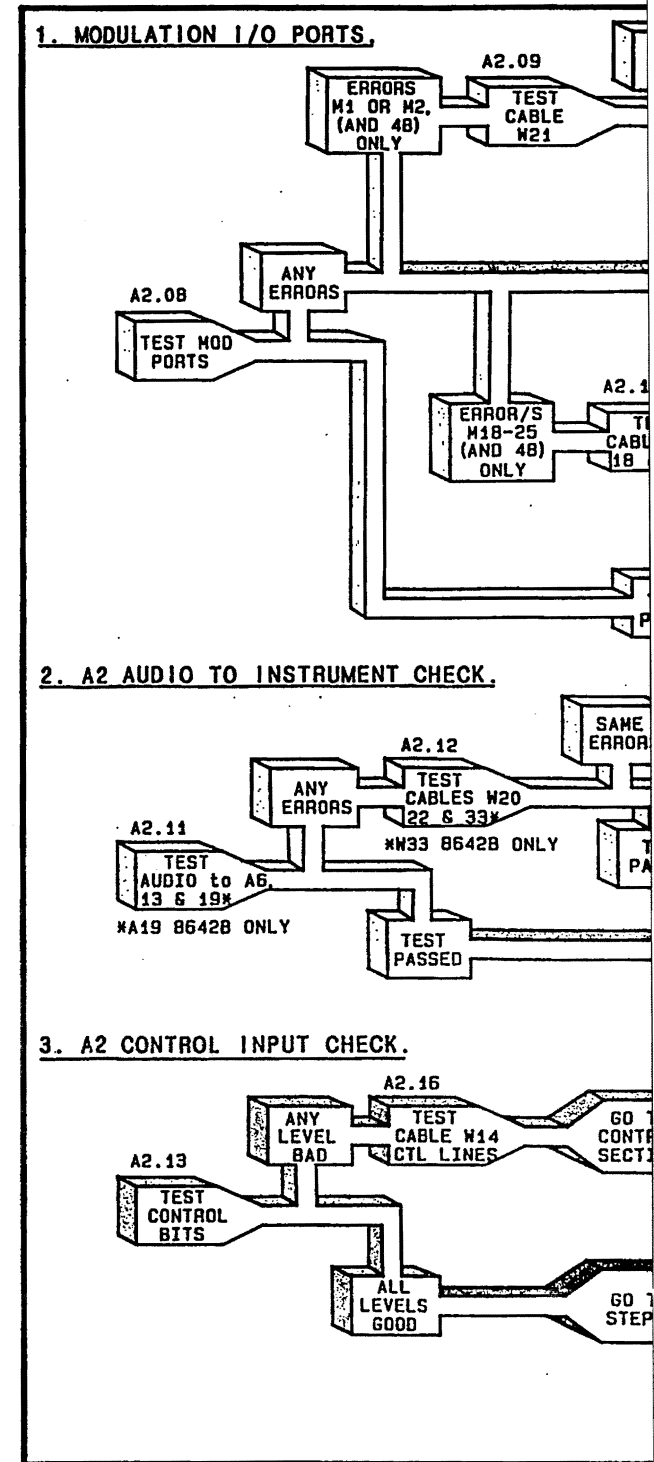

A2 INPUTS/OUTPUTS VERIFICATION

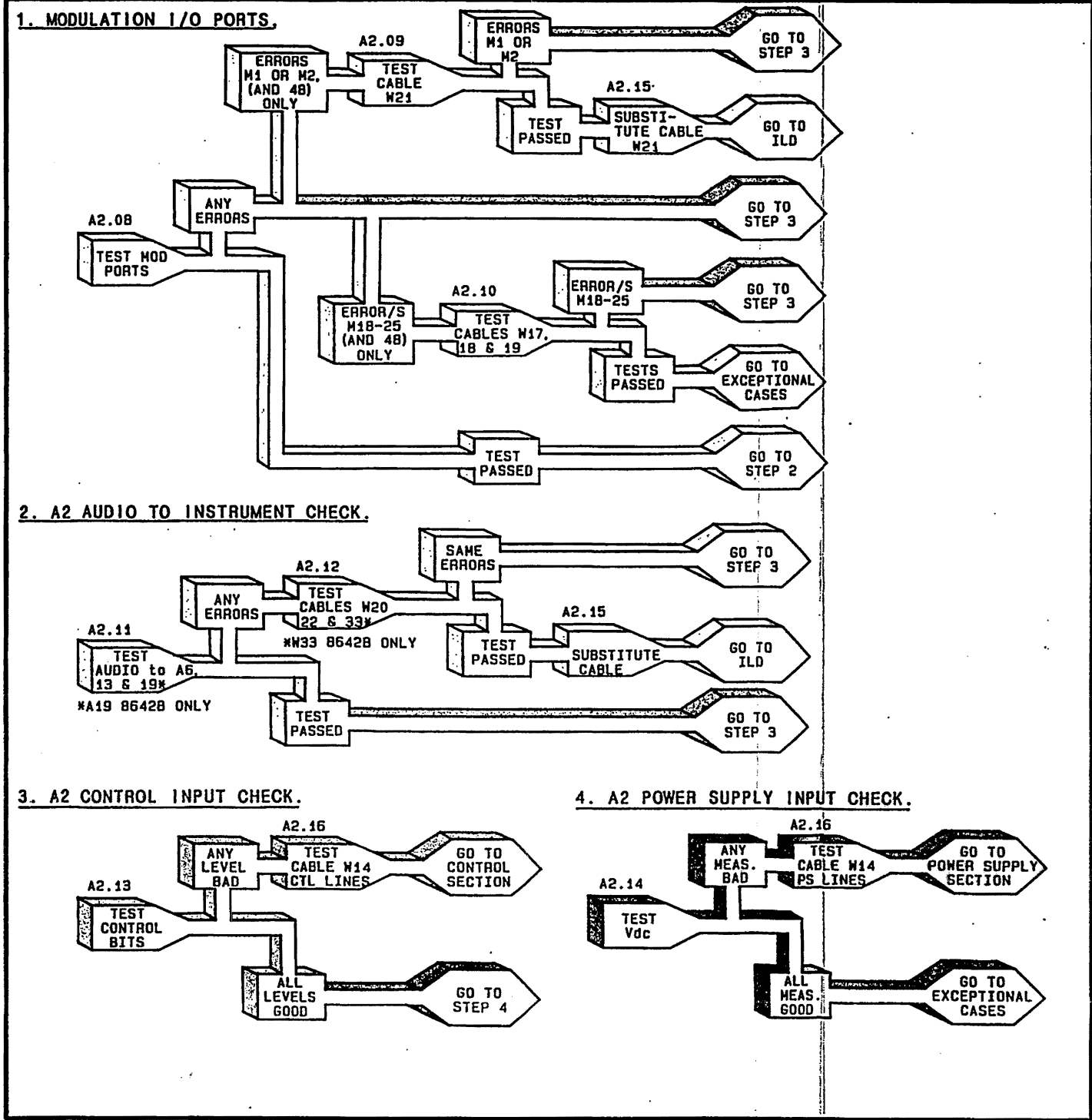

A2 MODULE I/O SIGNALS DIAGRAM

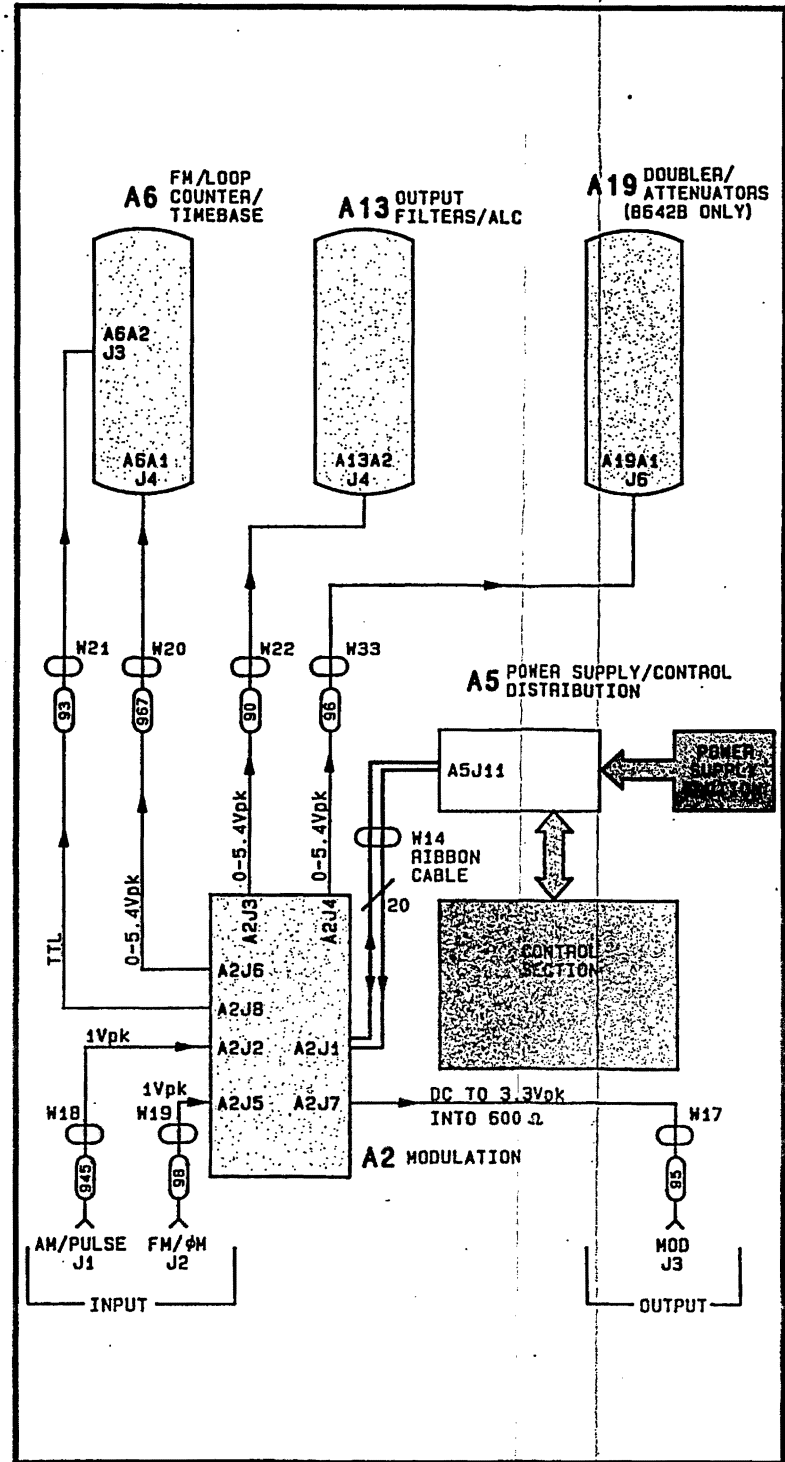
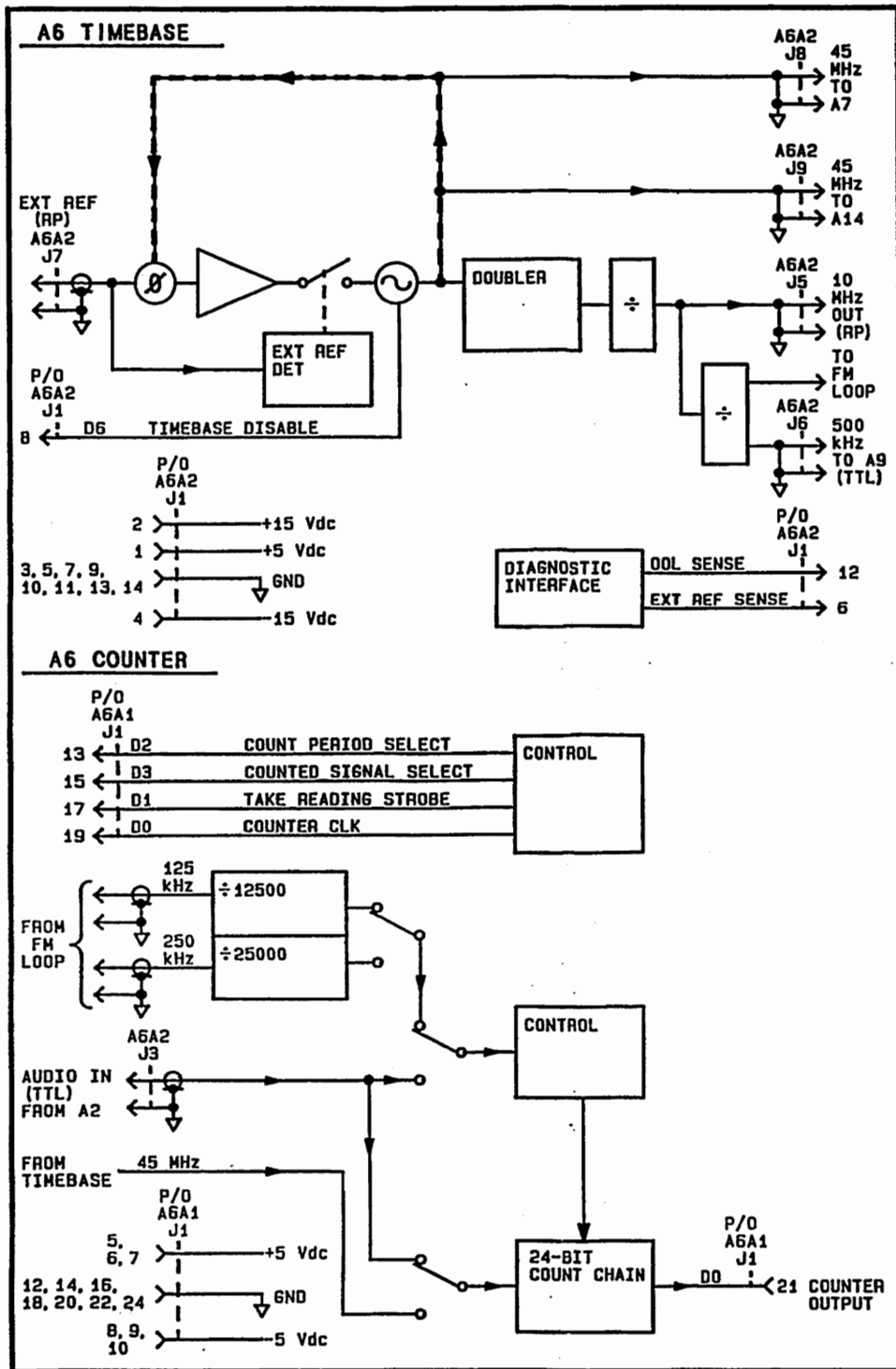
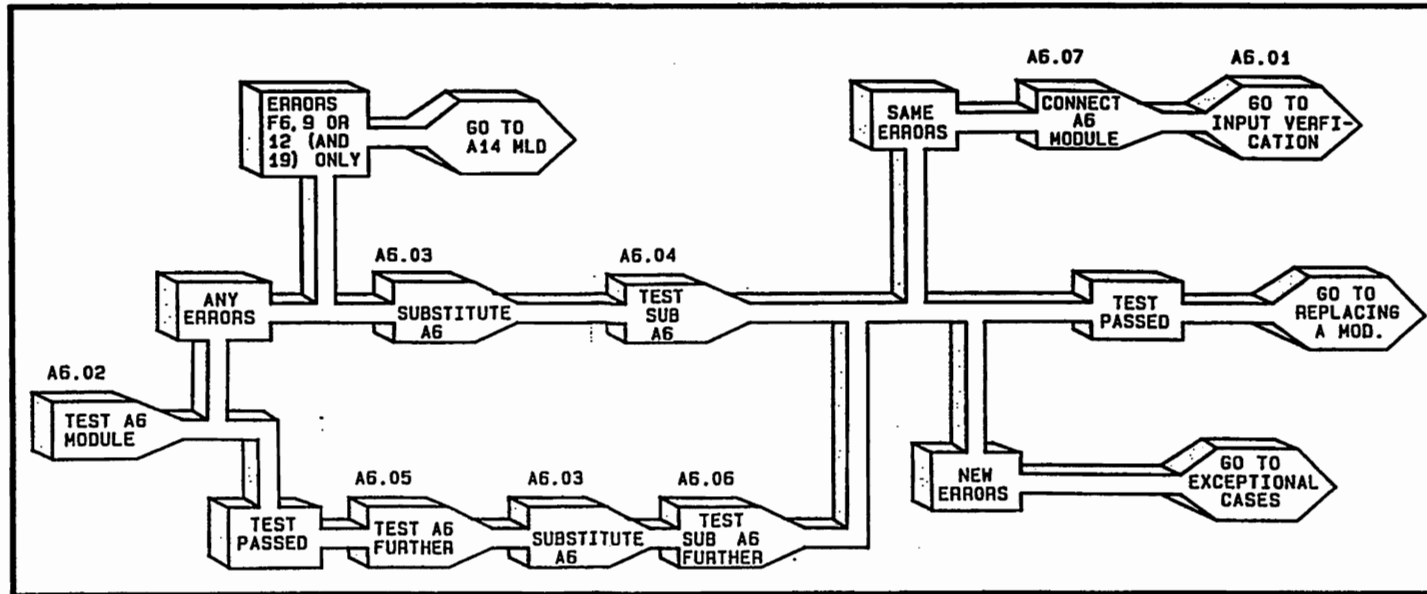

Figure 3E-100. A2 Modulation Module Diagnostics.

**A6 MODULE SIMPLIFIED BLOCK DIAGRAM**



**A6 MODULE SUBSTITUTION**



**A7 MODULE CABLE CONNECTION LOCATOR**

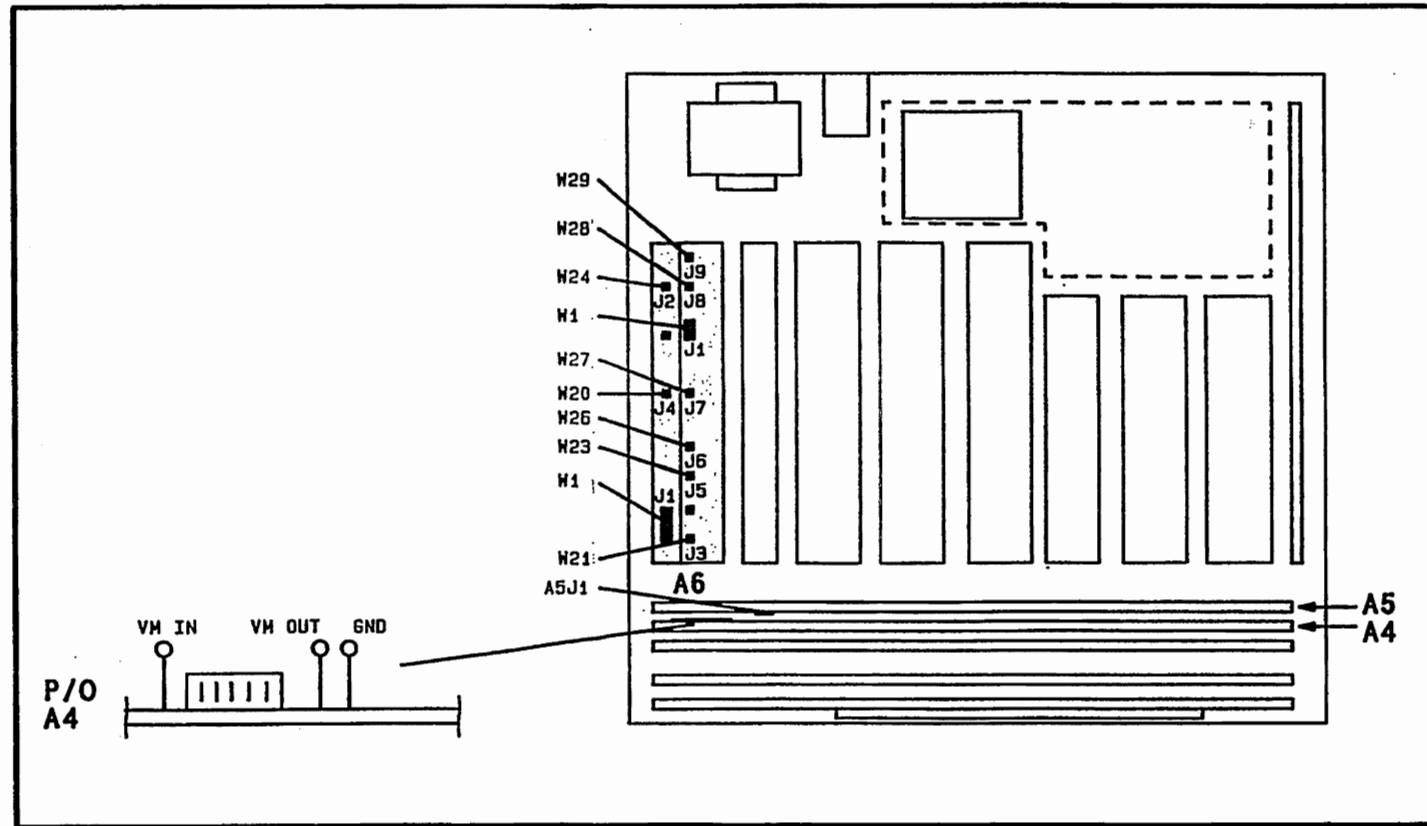

**A6 INPUT**

**1. A6 CONTROL INPUT CHECK.**

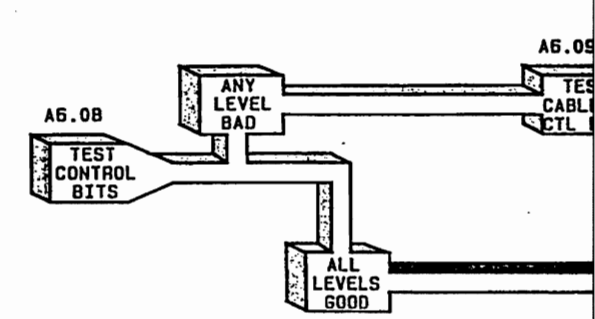

**2. A6 POWER SUPPLY INPUT CHECK.**

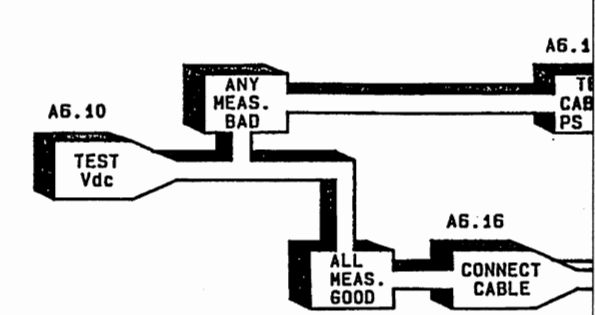

**3. A6 RF INPUT CHECK.**

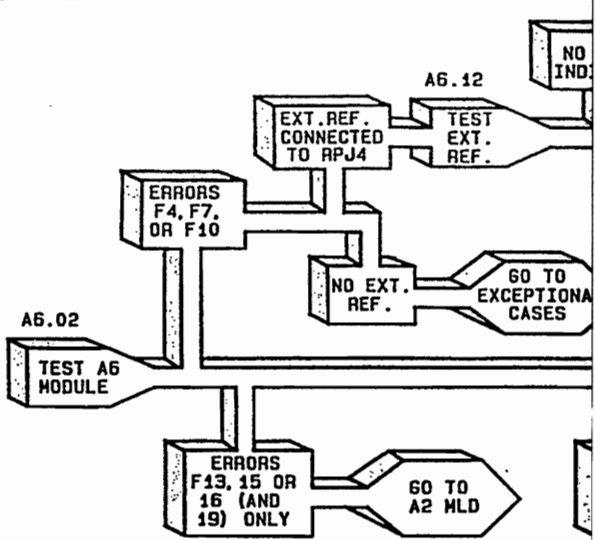



MODULE SUBSTITUTION

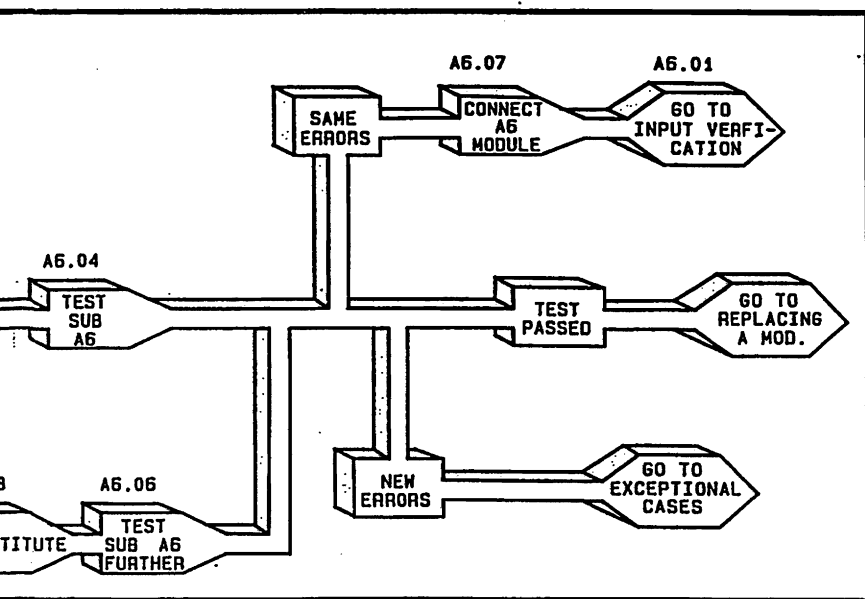

CABLE CONNECTION LOCATOR

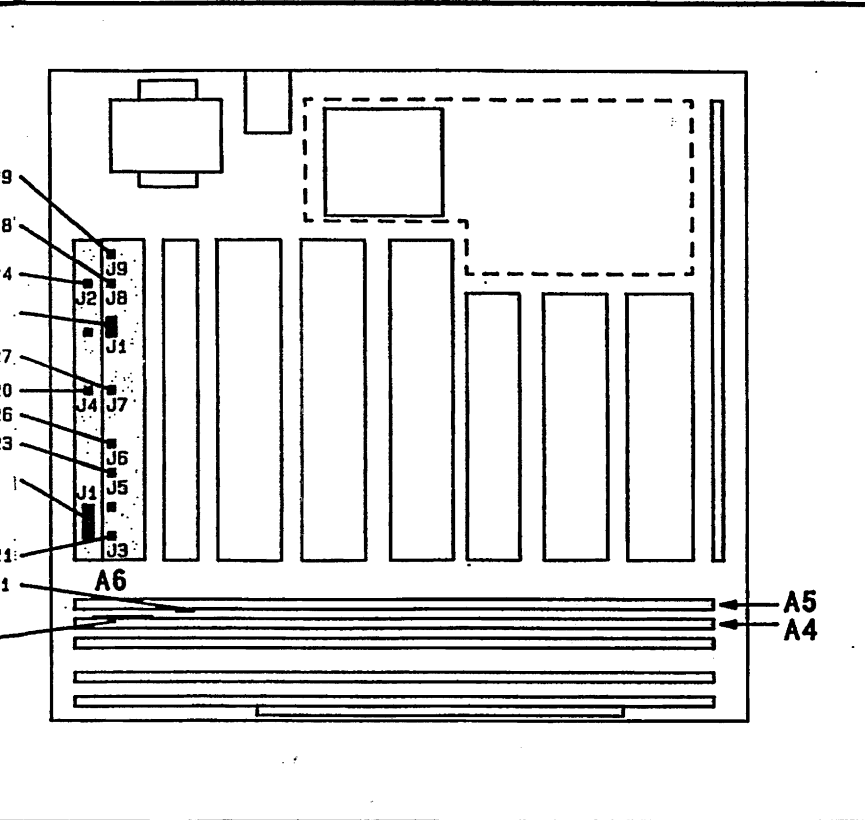

A6 INPUTS VERIFICATION

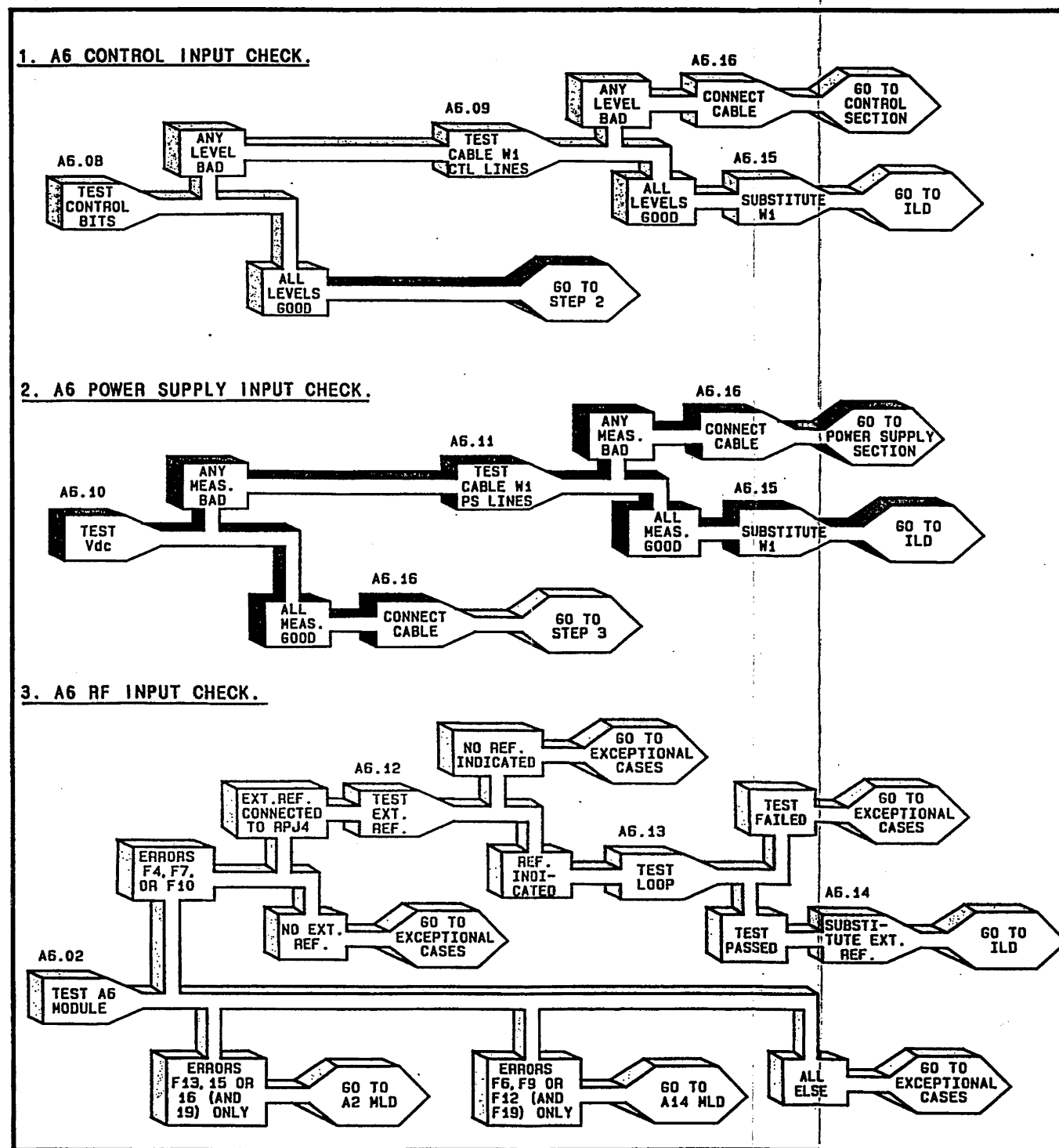

A6 MODULE I/O SIGNALS DIAGRAM

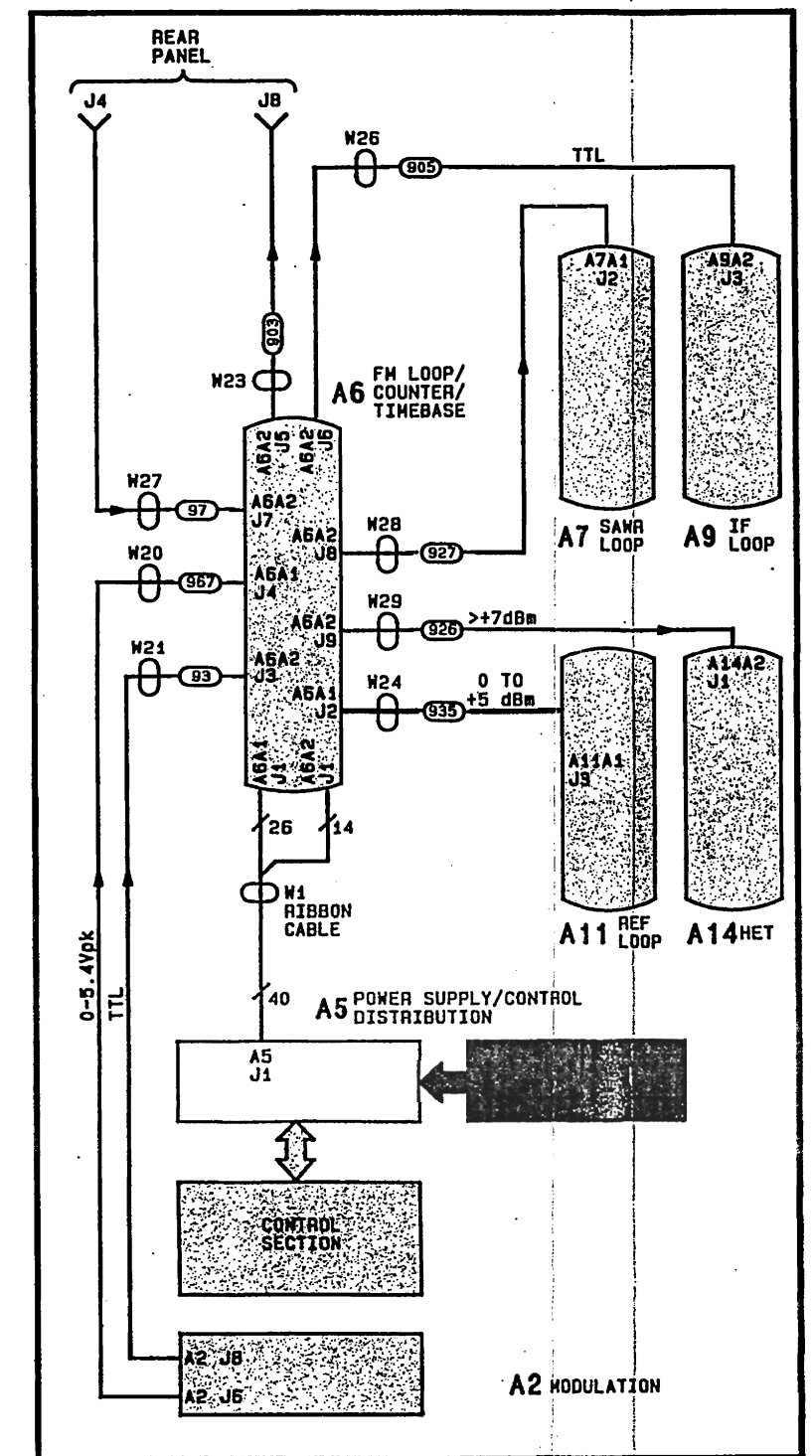
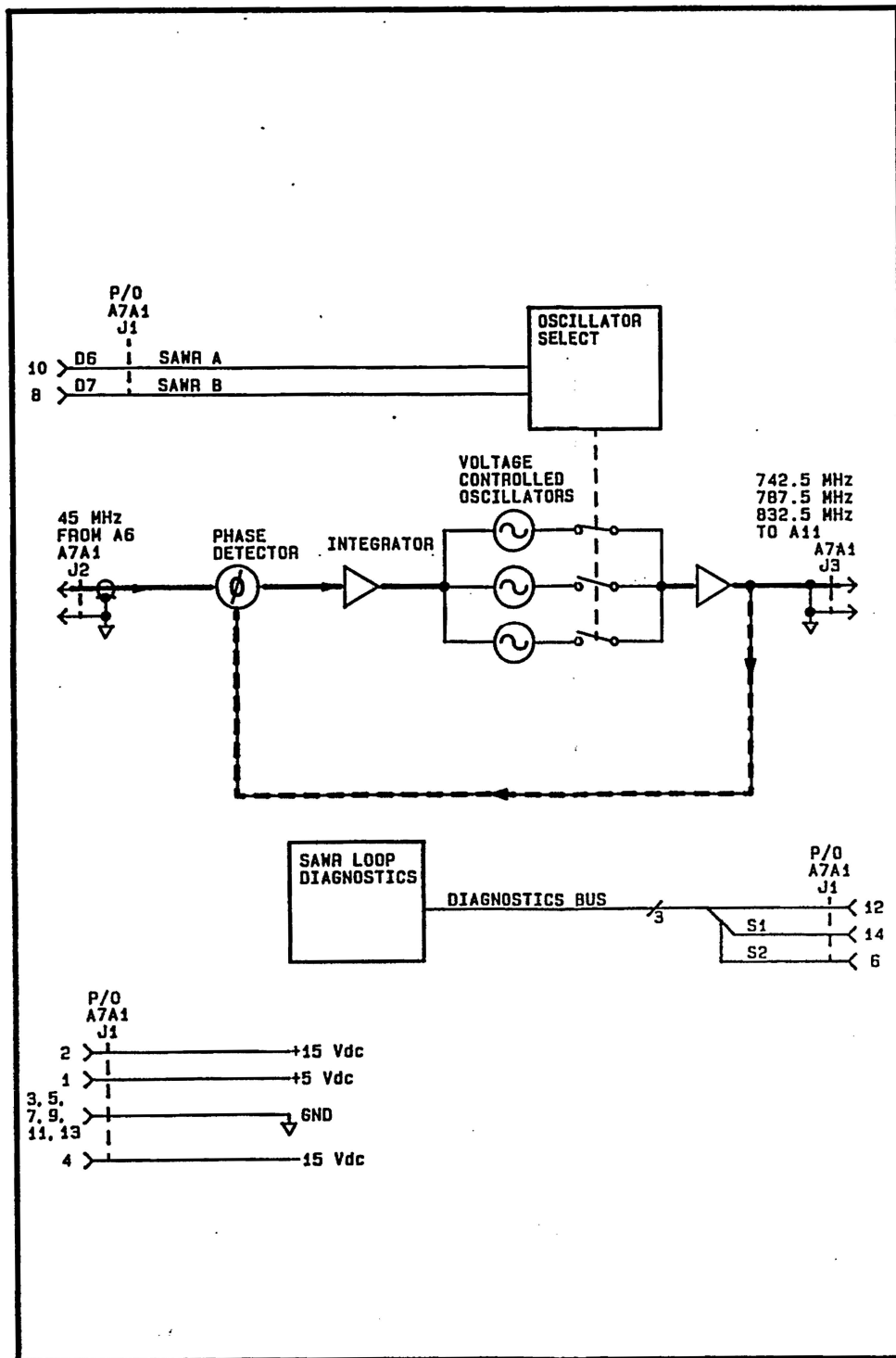
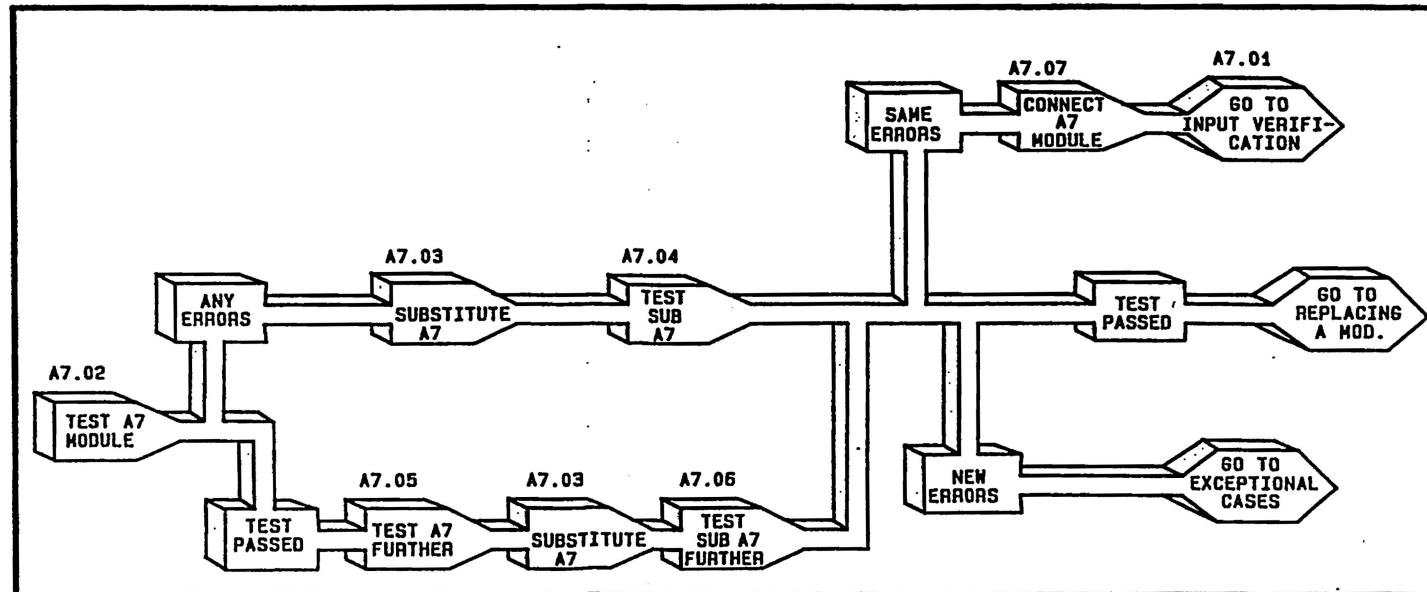

Figure 3F-100. A6 FM Loop/Counter/Timebase Module Diagnostics.

A7 MODULE SIMPLIFIED BLOCK DIAGRAM



A7 MODULE SUBSTITUTION



A7 MODULE CABLE CONNECTION LOCATOR

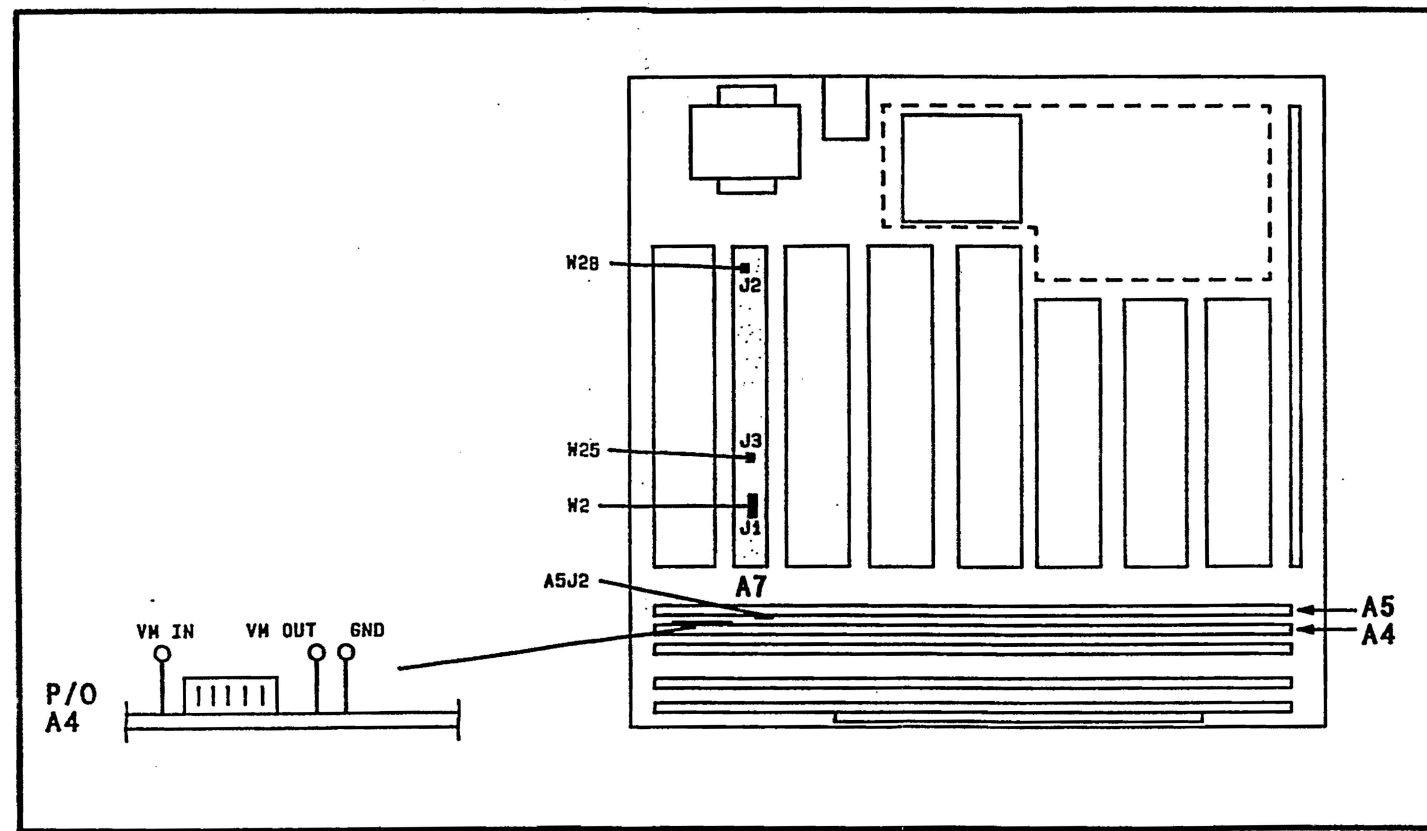

A7 INPUT

1. A7 RF INPUT CHECK.

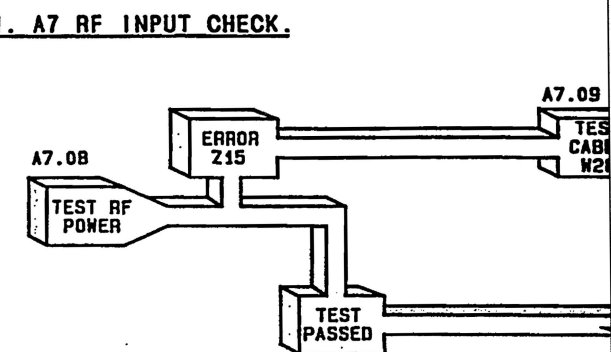

2. A7 CONTROL INPUT CHECK.

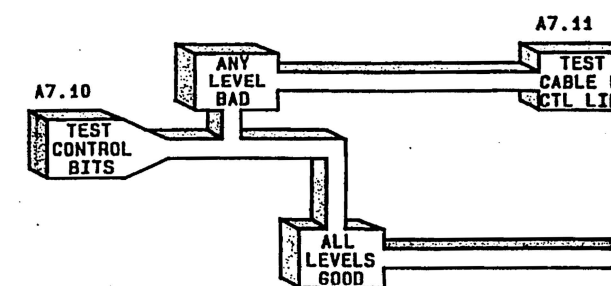

3. A7 POWER SUPPLY INPUT CHECK.

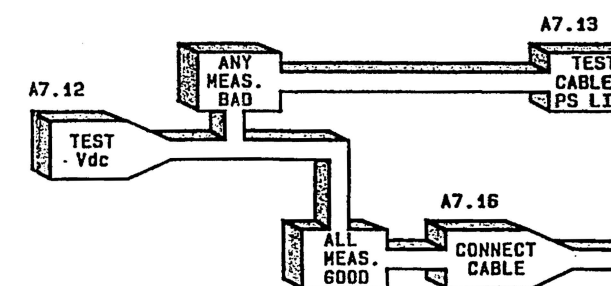

MODULE SUBSTITUTION

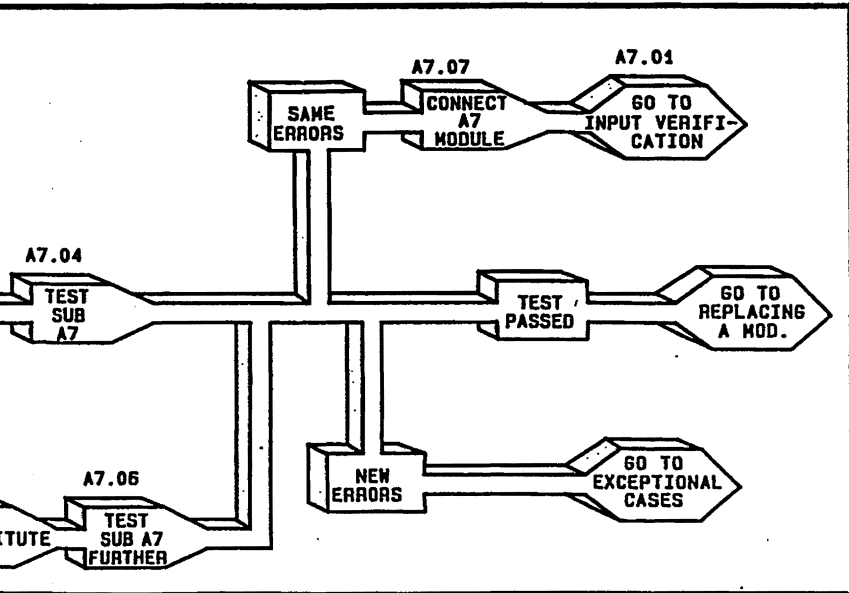

CABLE CONNECTION LOCATOR

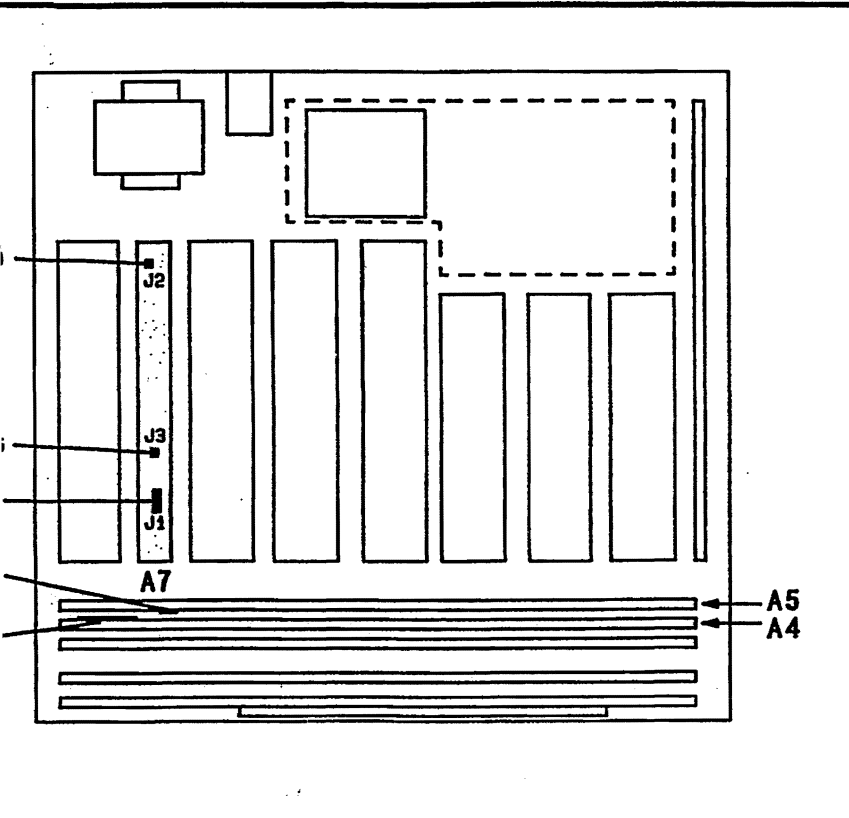

A7 INPUTS VERIFICATION

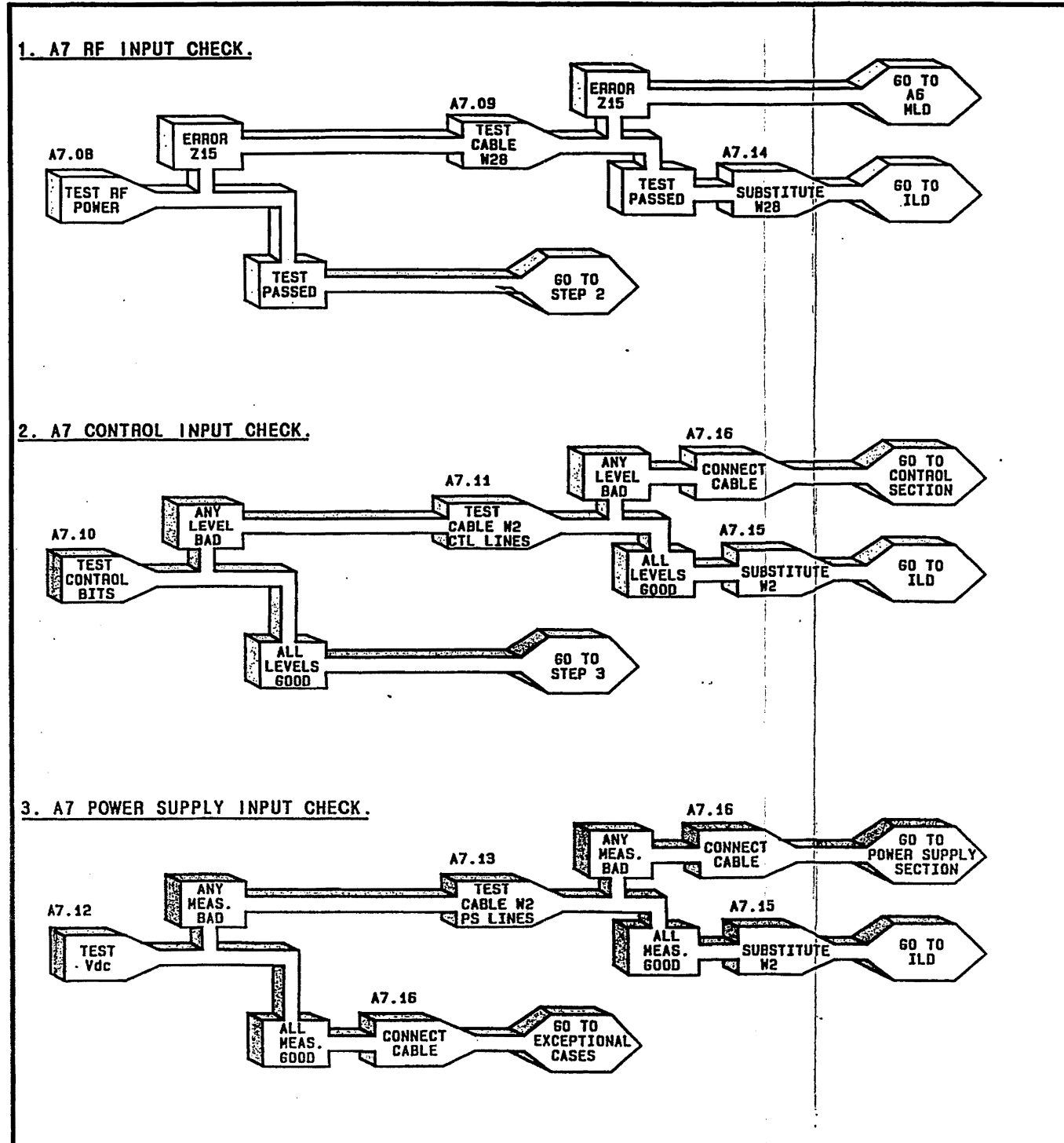

A7 MODULE I/O SIGNALS DIAGRAM

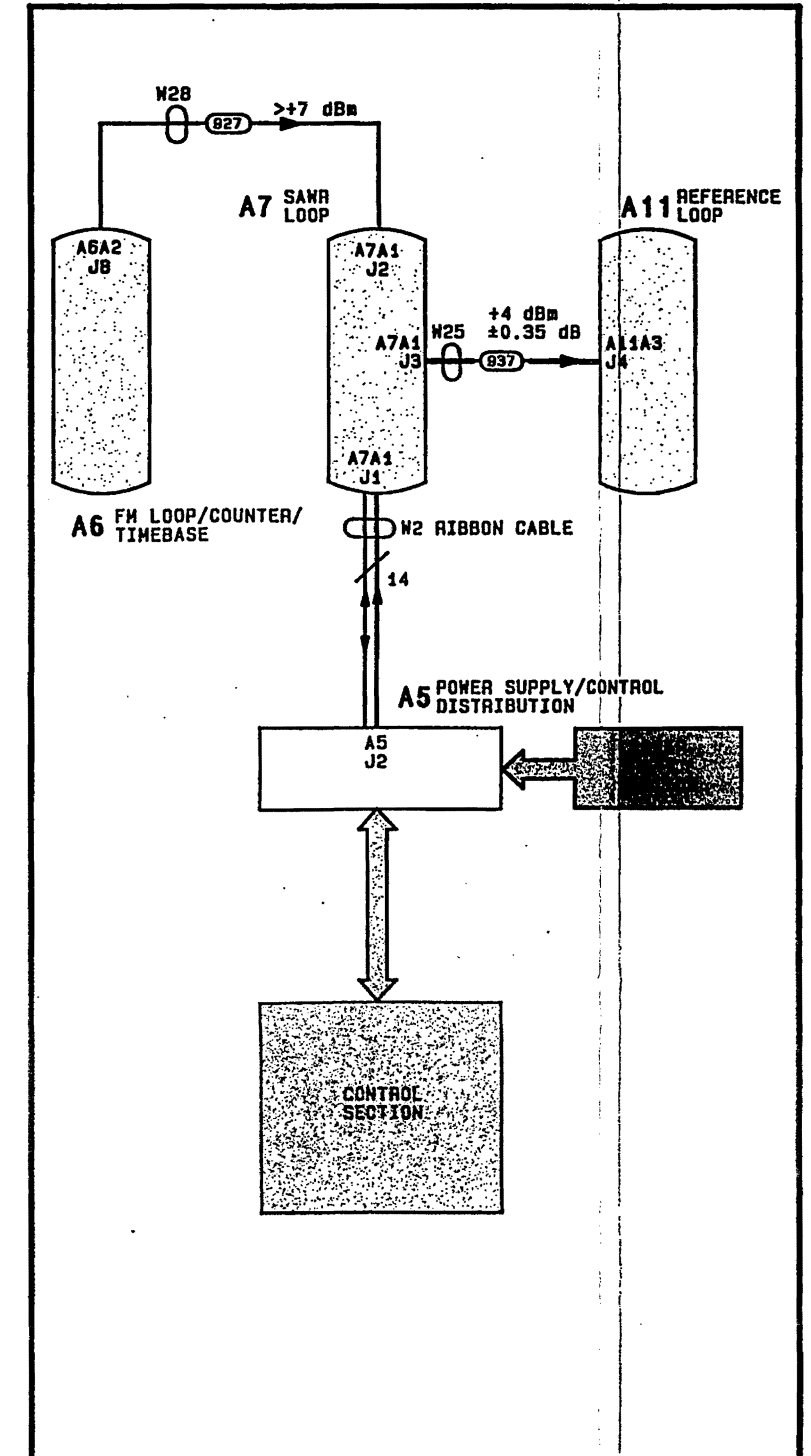
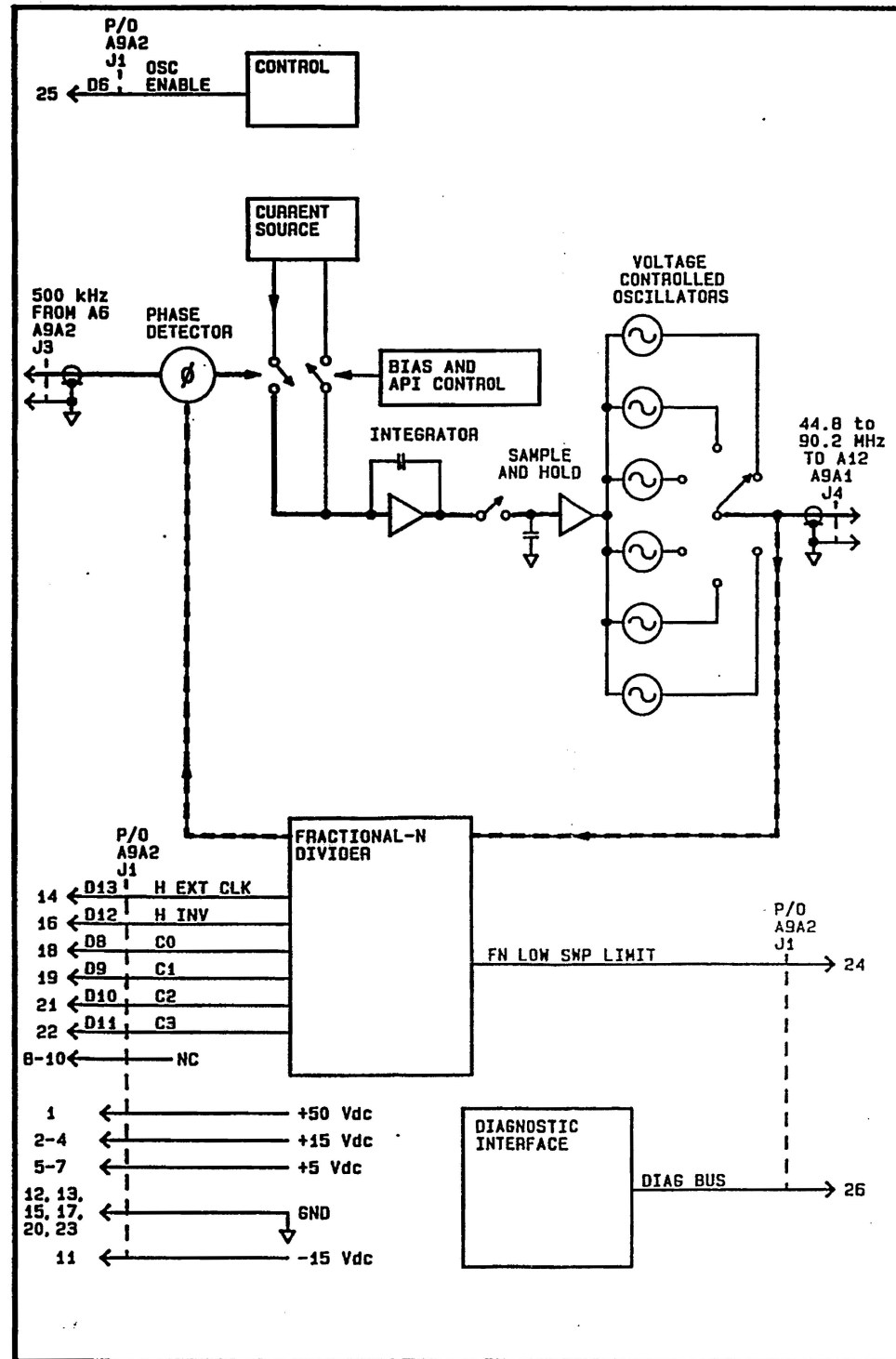
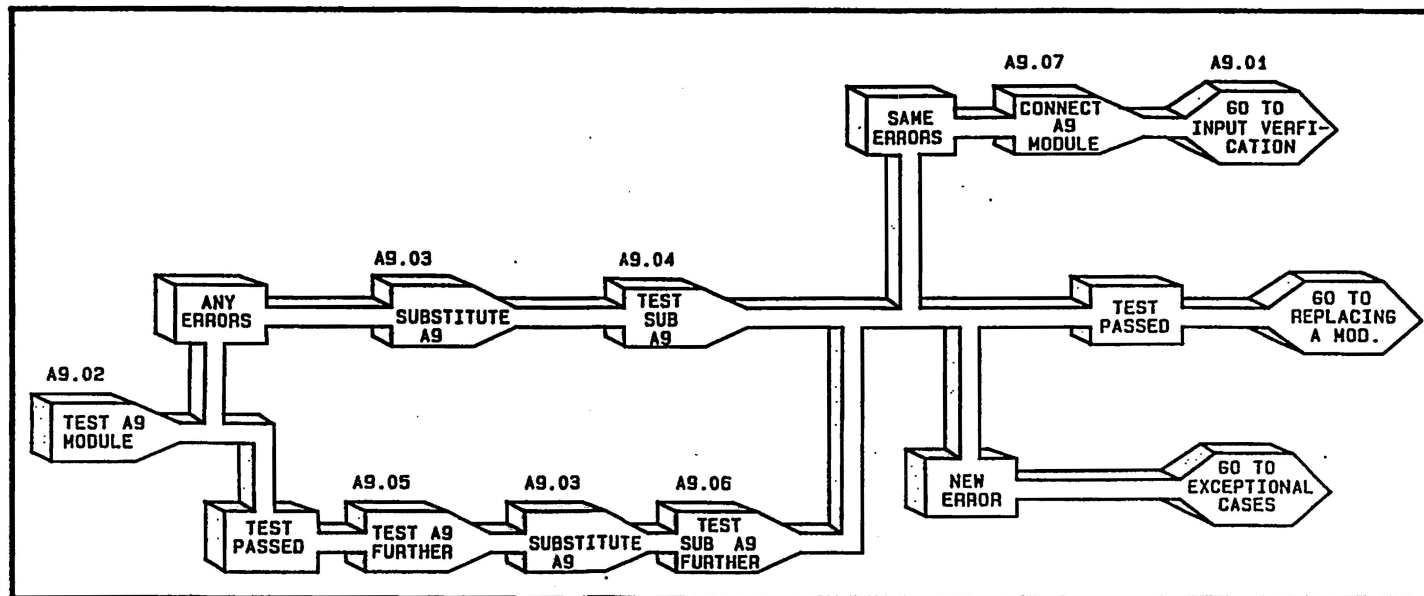

Figure 3G-100. A7 SAWR Loop Module Diagnostics.

A9 MODULE SIMPLIFIED BLOCK DIAGRAM



A9 MODULE SUBSTITUTION



A9 MODULE CABLE CONNECTION LOCATOR

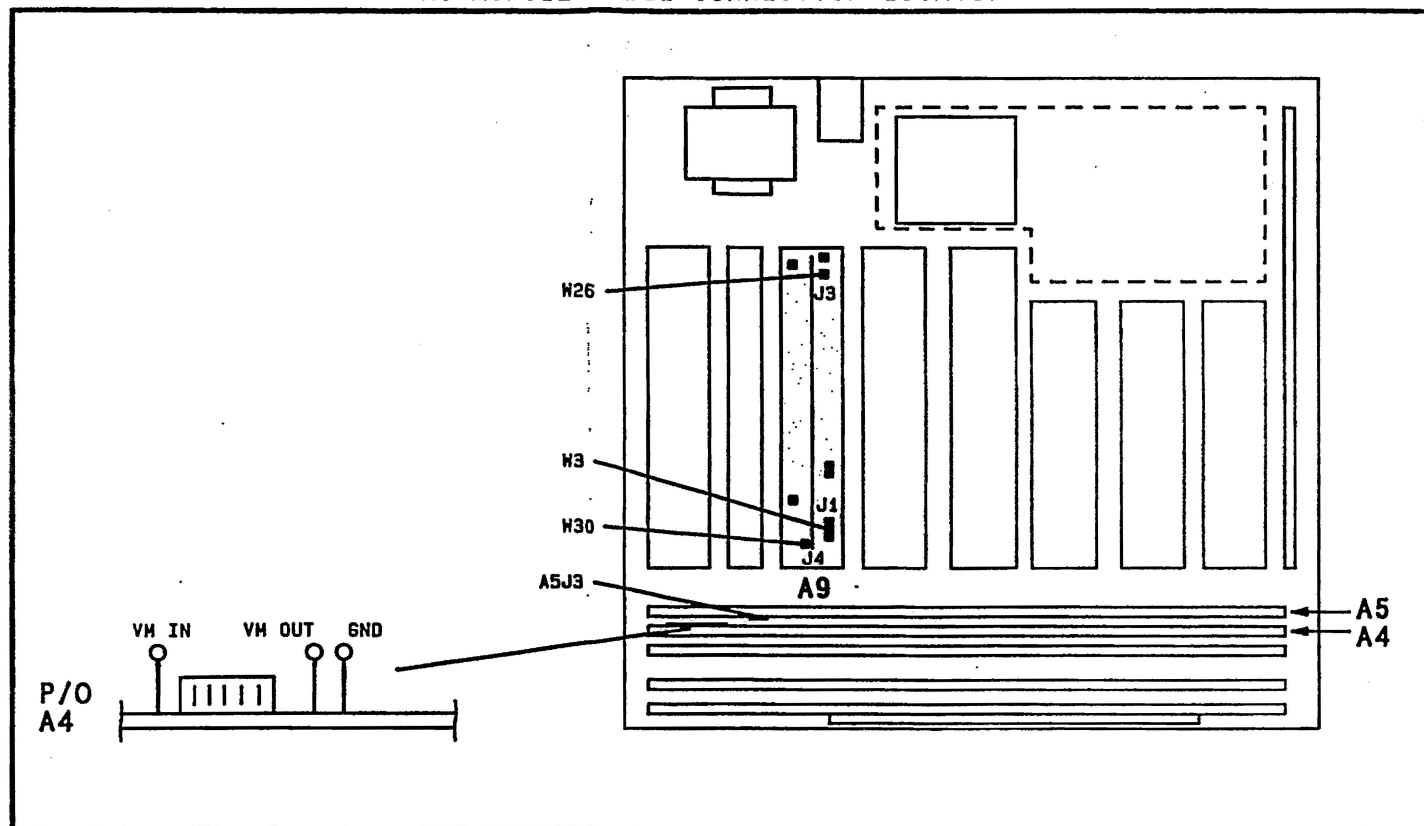

1. A9 RF INPUT CHECK.

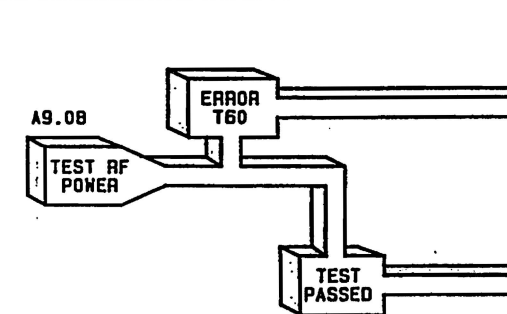

2. A9 CONTROL INPUT CHECK.

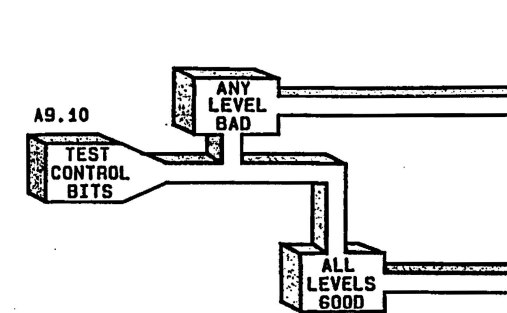

3. A9 POWER SUPPLY INPUT CHECK.

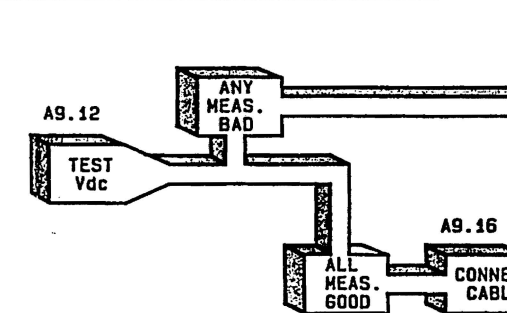

**A9 MODULE SUBSTITUTION**

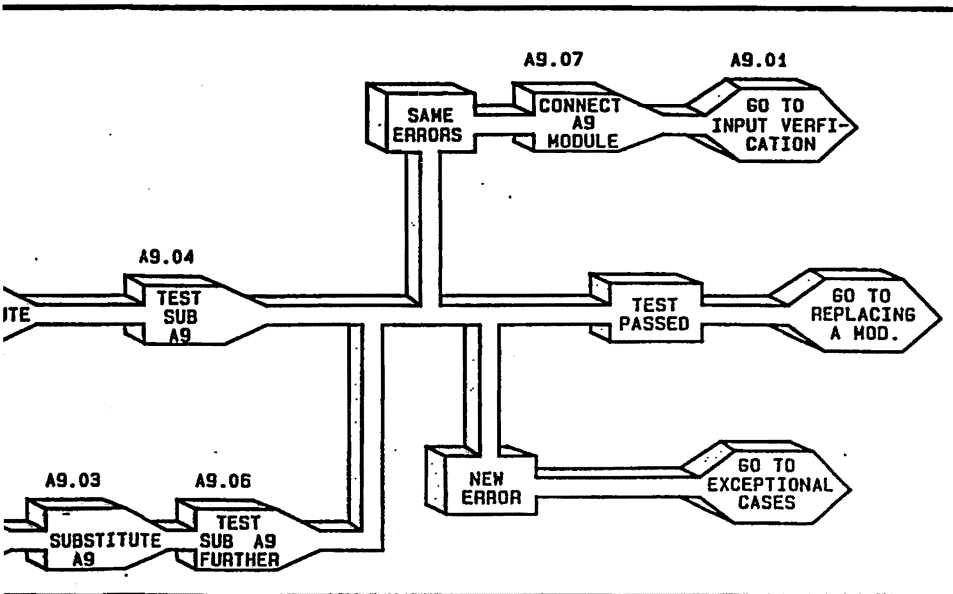

**MODULE CABLE CONNECTION LOCATOR**

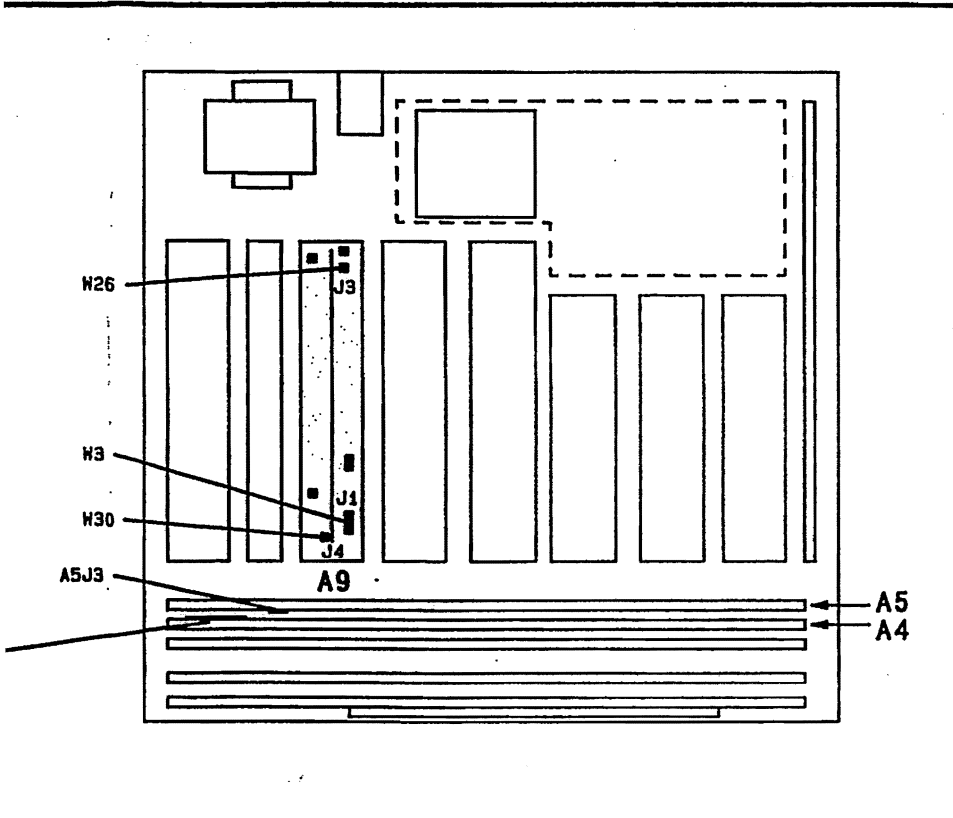

**A9 INPUTS VERIFICATION**

**1. A9 RF INPUT CHECK.**

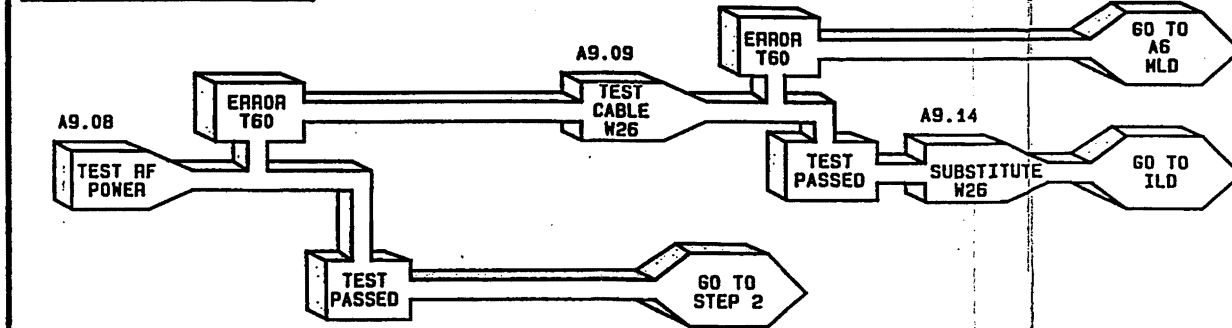

**2. A9 CONTROL INPUT CHECK.**

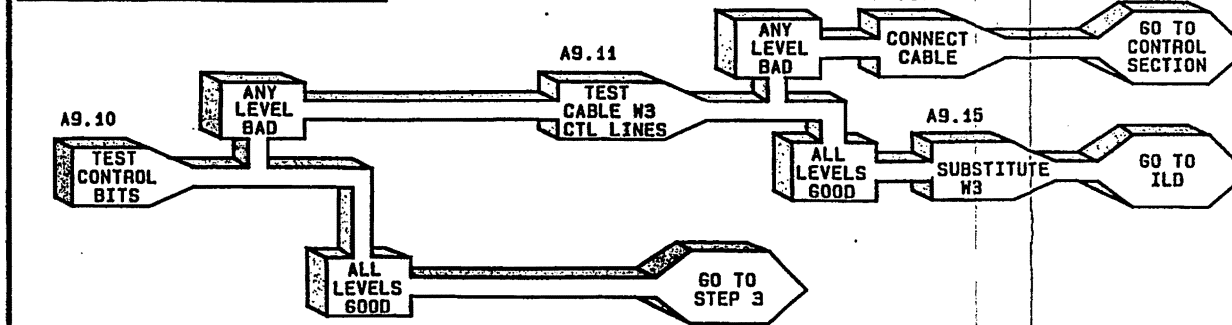

**3. A9 POWER SUPPLY INPUT CHECK.**

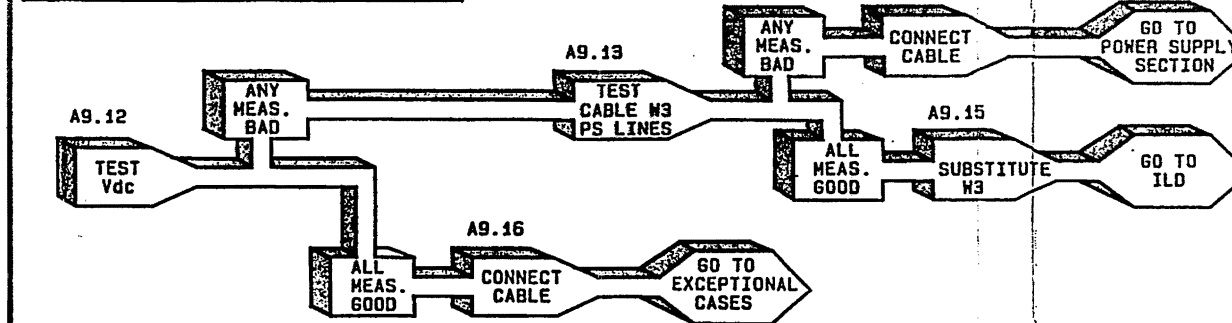

**A9 MODULE I/O SIGNALS DIAGRAM**

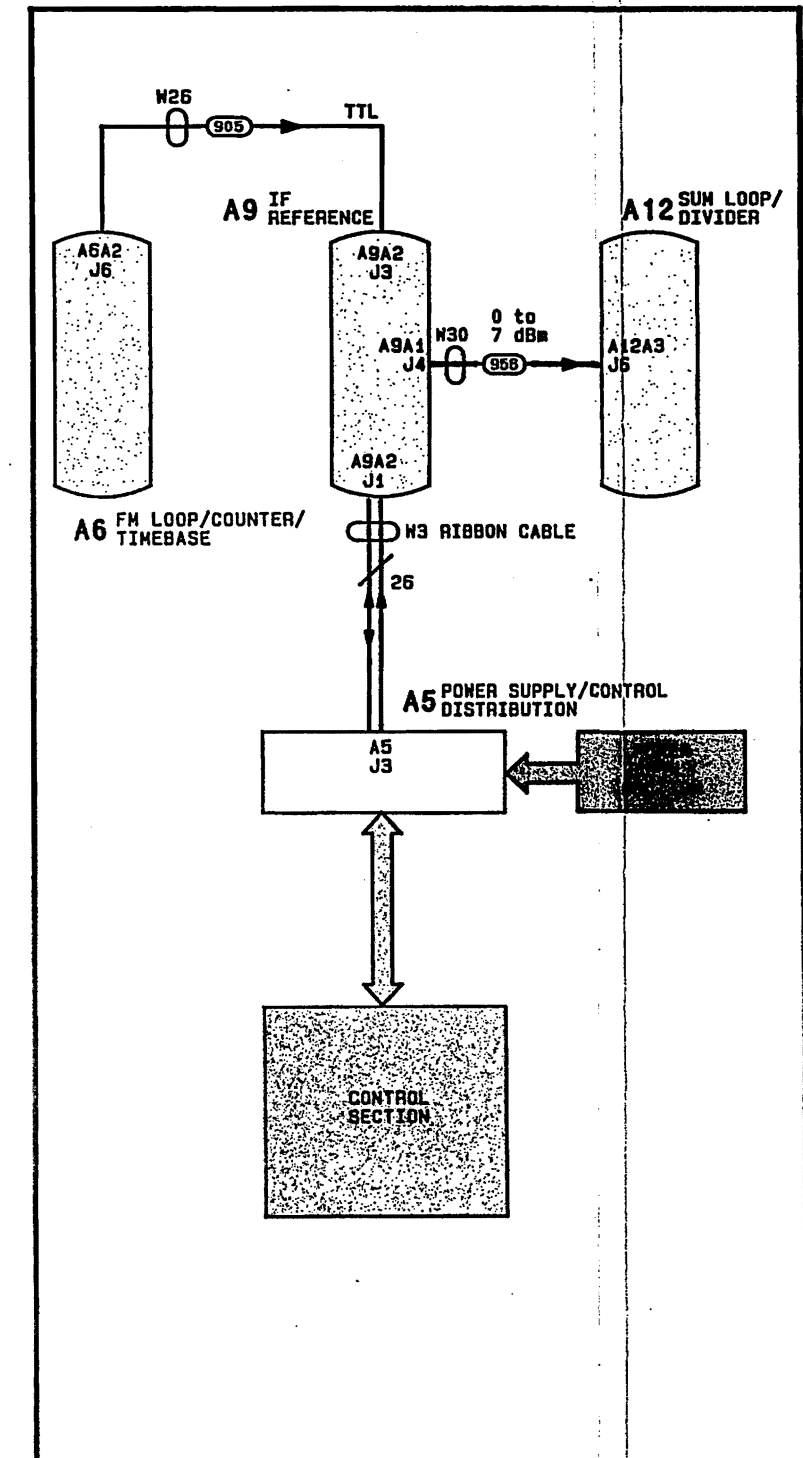
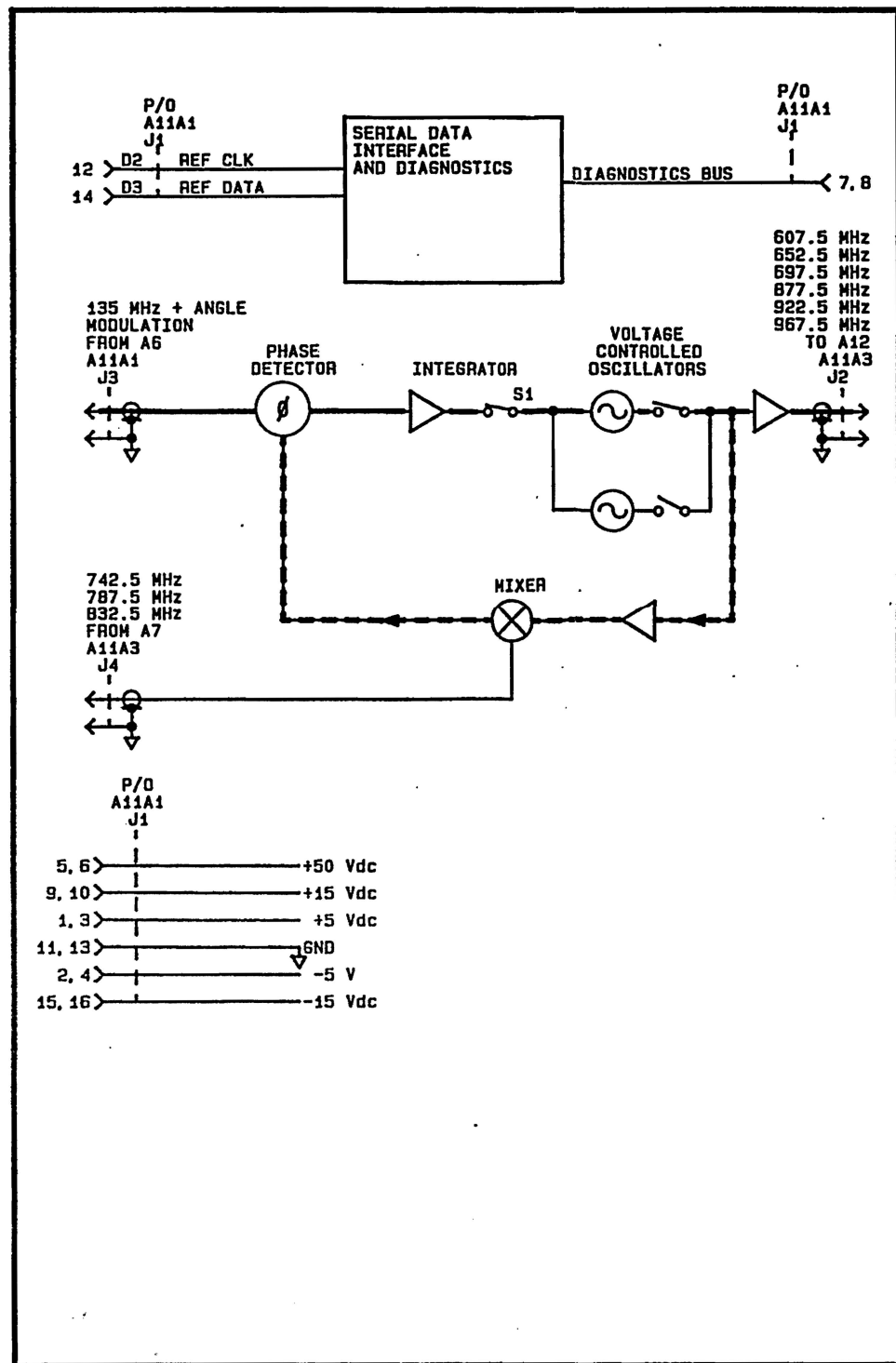

Figure 3H-100. A9 IF Reference Module Diagnostics.

A11 MODULE SIMPLIFIED BLOCK DIAGRAM



A11 INPUTS VERIFICATION

1. A11 RF INPUT CHECK.

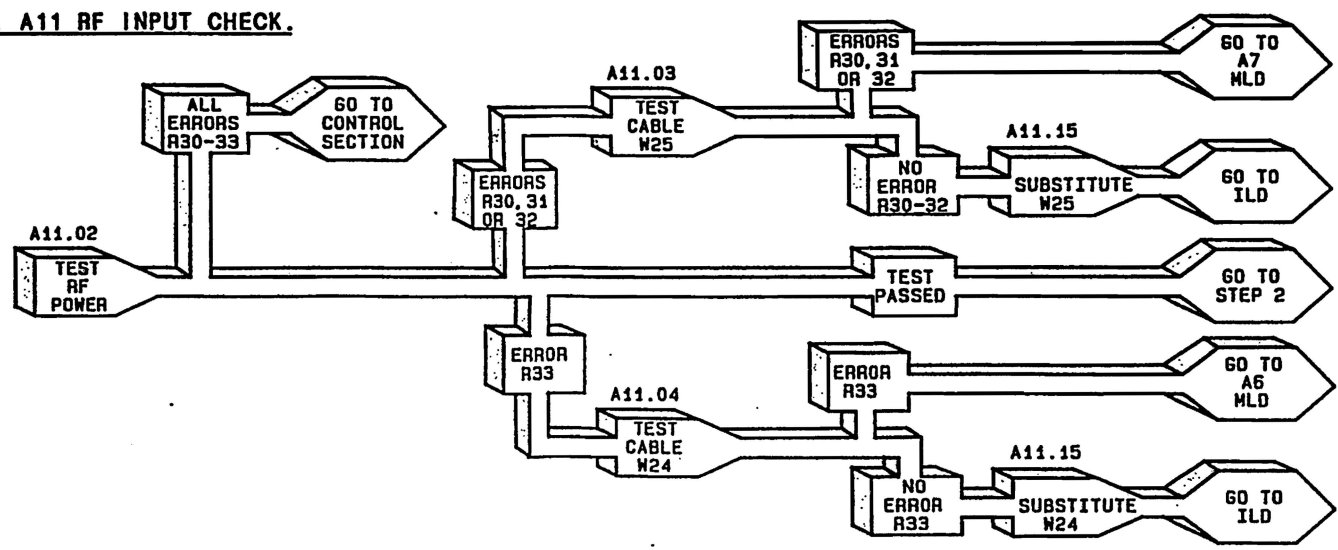

2. A11 CONTROL INPUT CHECK.

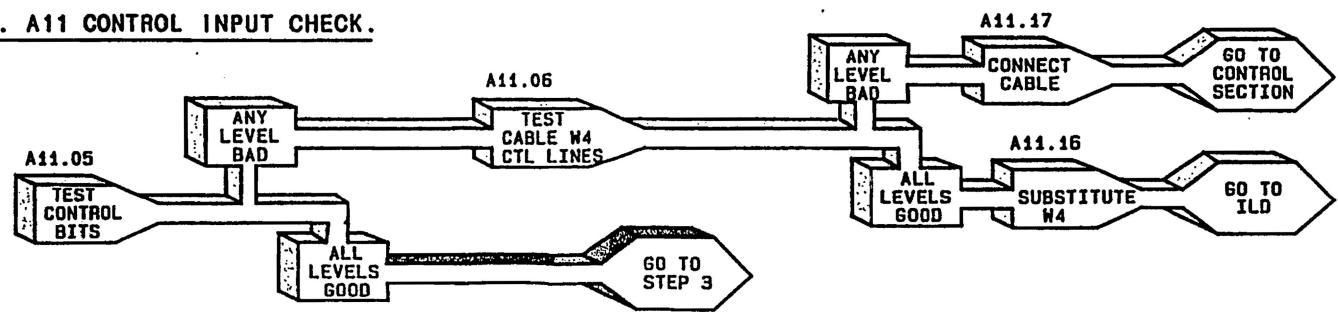

3. A11 POWER SUPPLY INPUT CHECK.

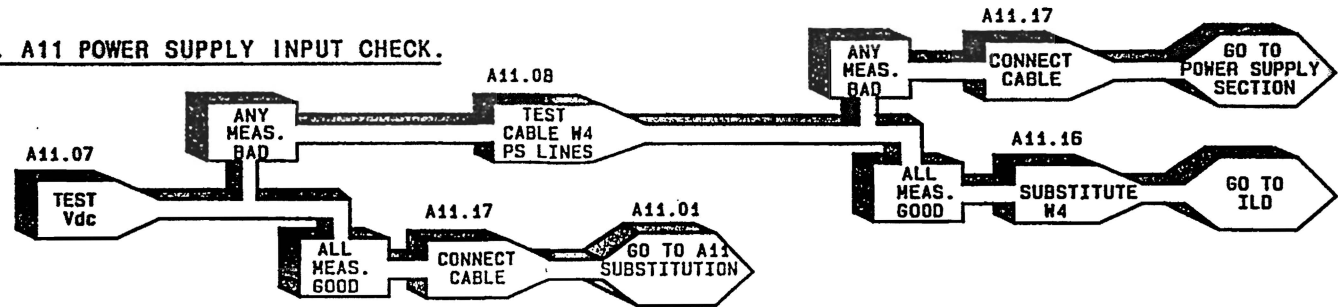

A11 MO

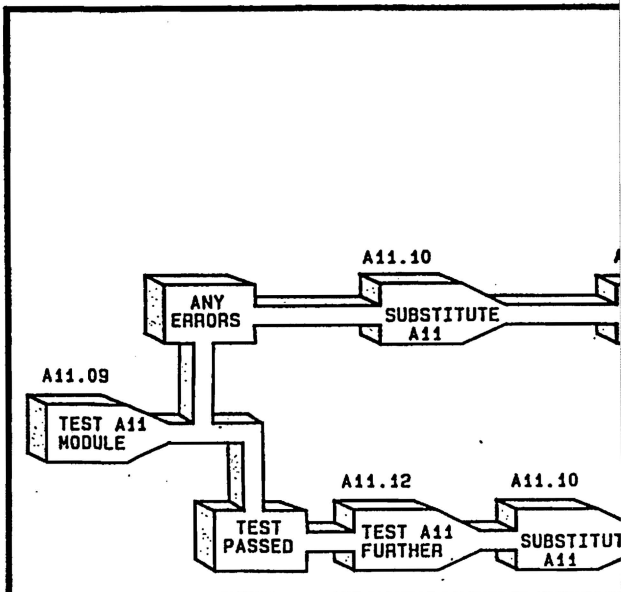

A11 MODULE CA

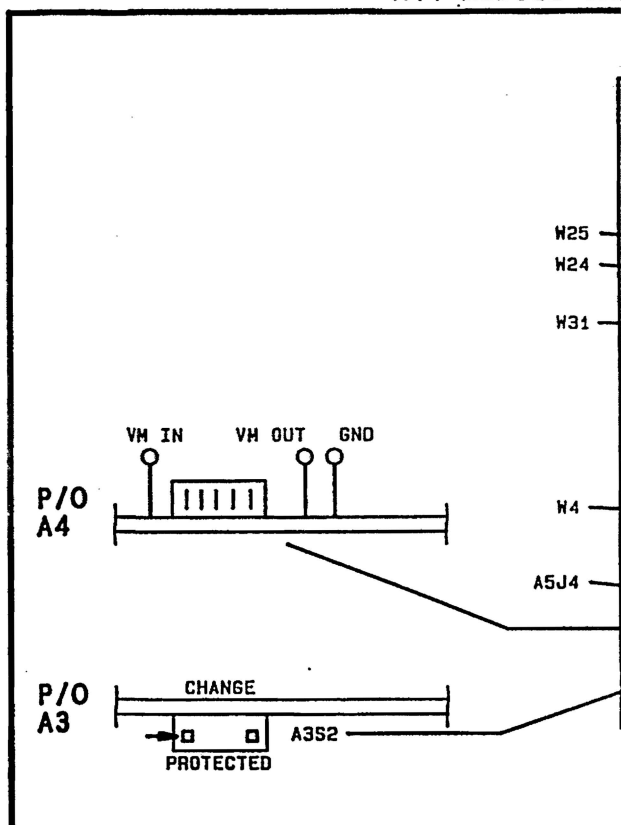

A11 INPUTS VERIFICATION

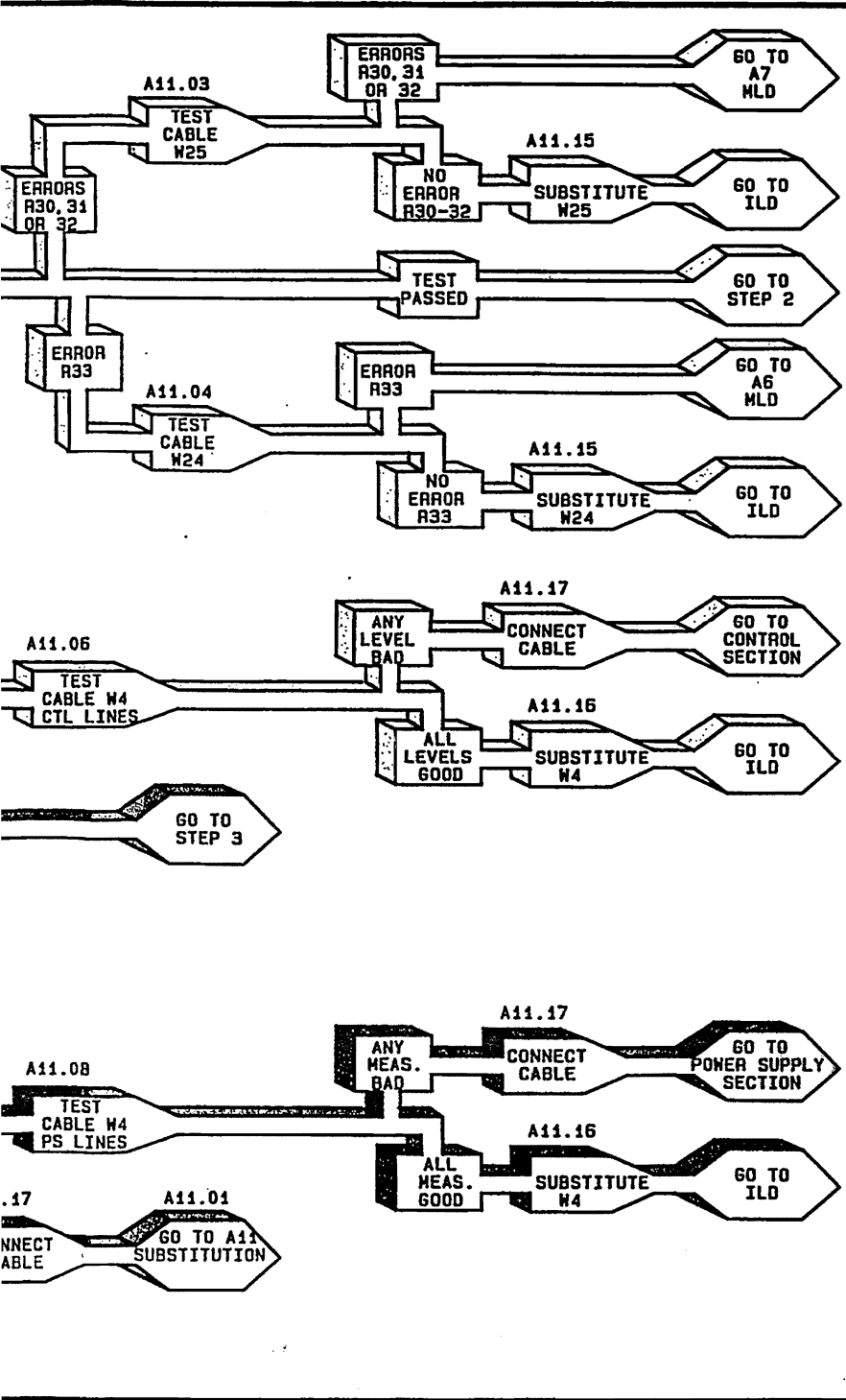

A11 MODULE SUBSTITUTION

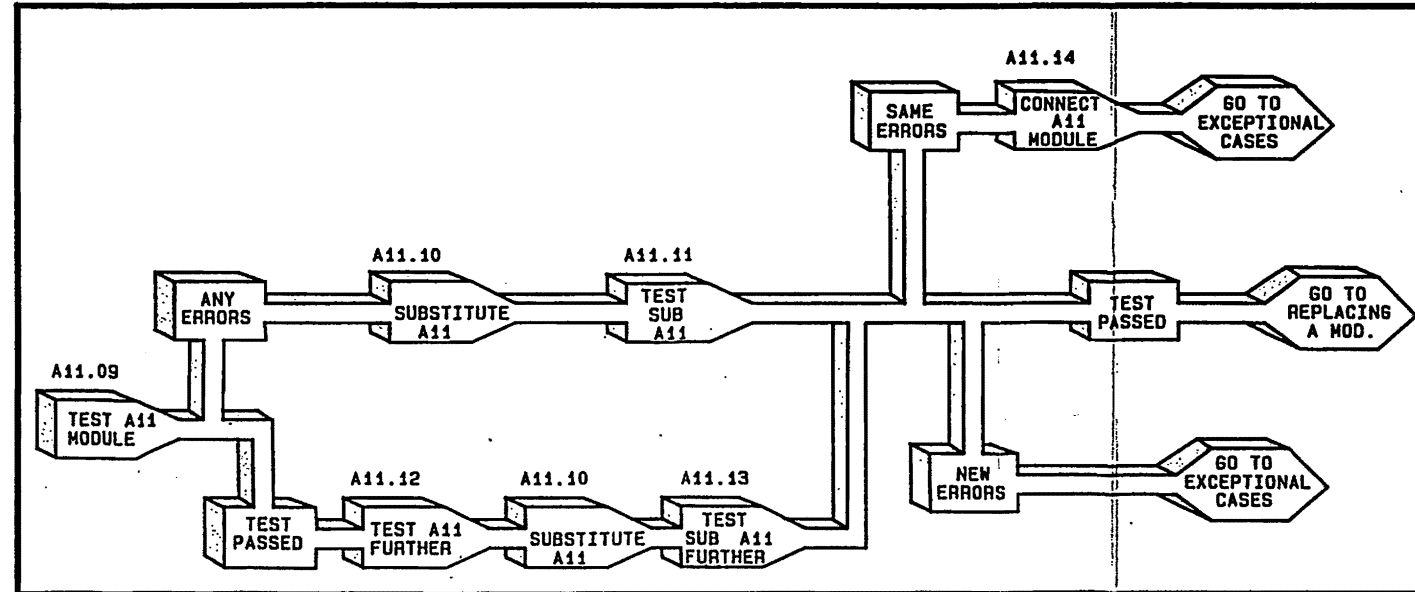

A11 MODULE CABLE CONNECTION LOCATOR

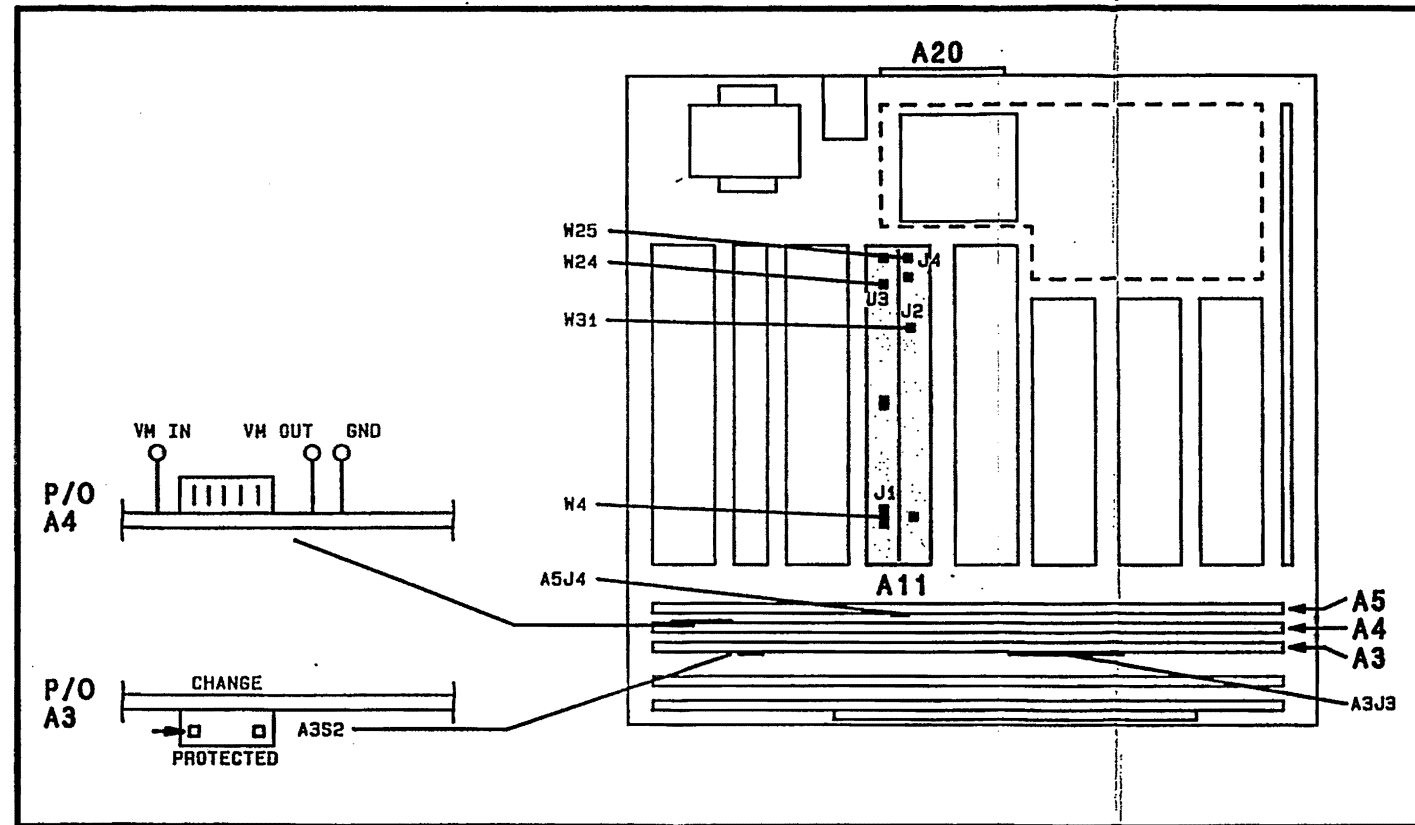

A11 MODULE I/O SIGNALS DIAGRAM

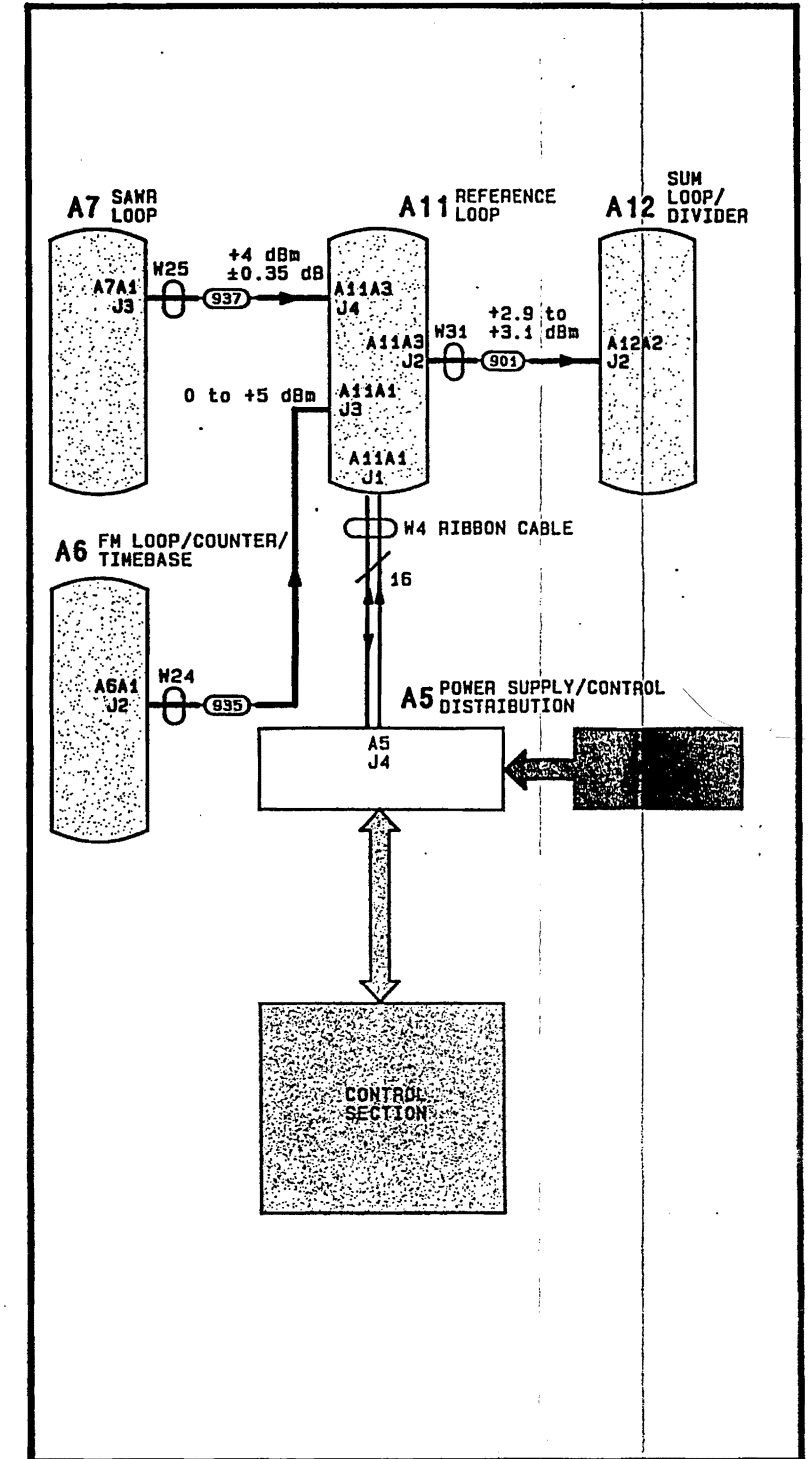
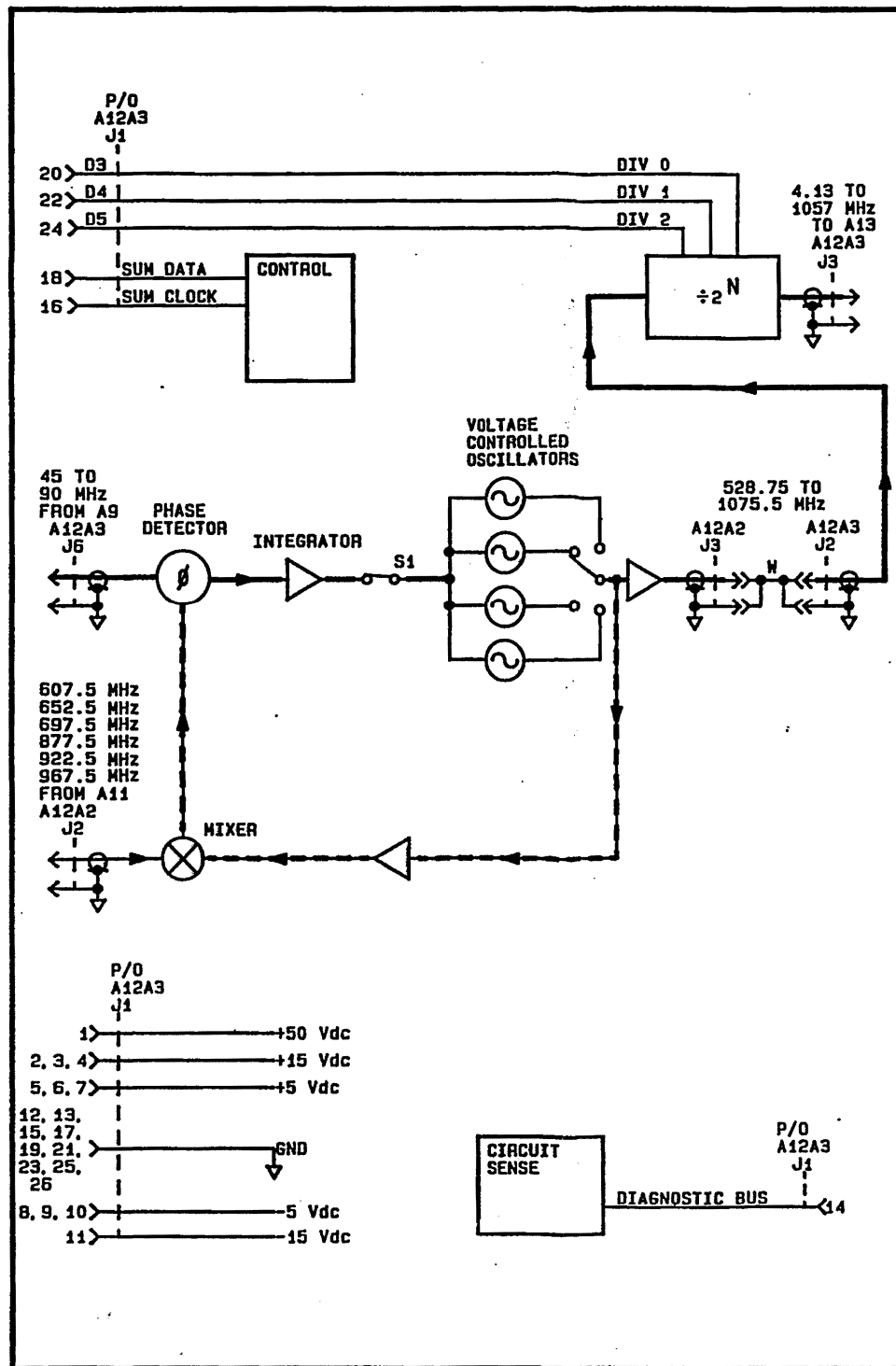
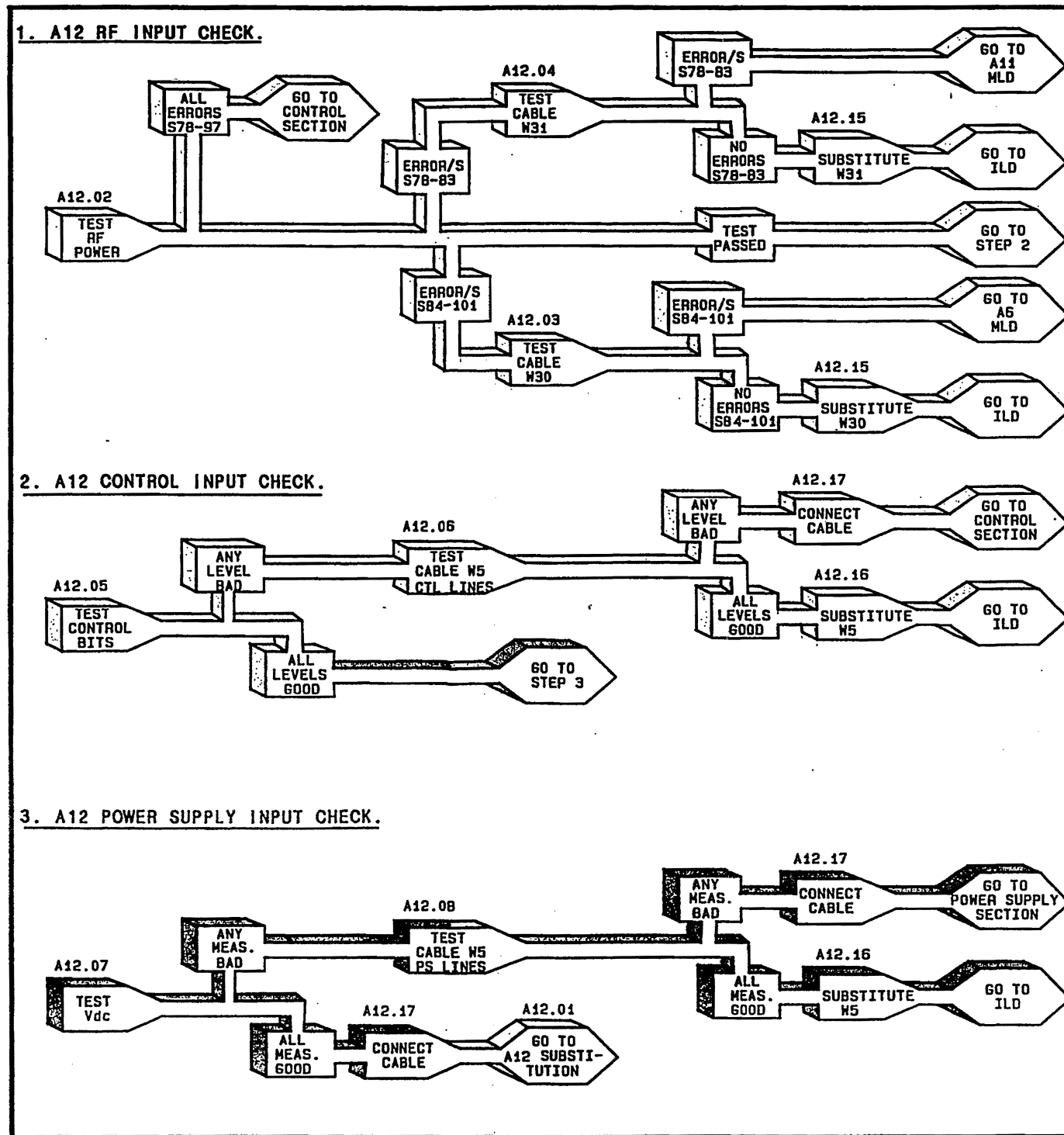

Figure 31-100. A11 Reference Loop Module Diagnostics.

A12 MODULE SIMPLIFIED BLOCK DIAGRAM



A12 INPUTS VERIFICATION



A12 MOD

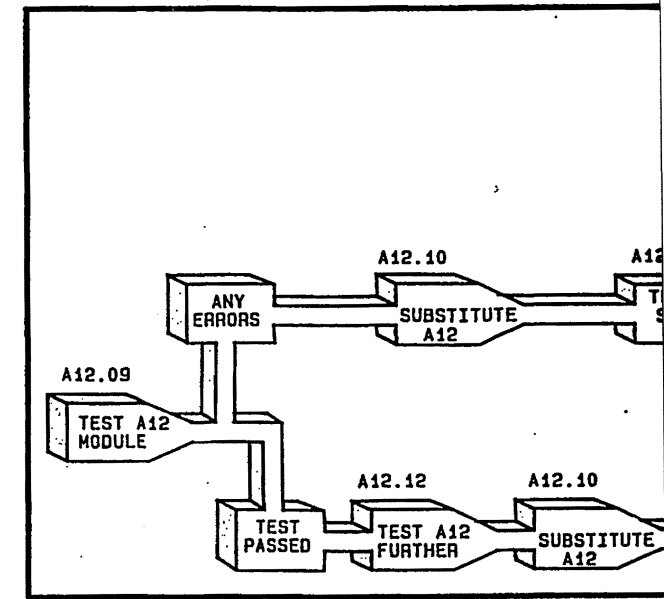

A12 MODULE CABL

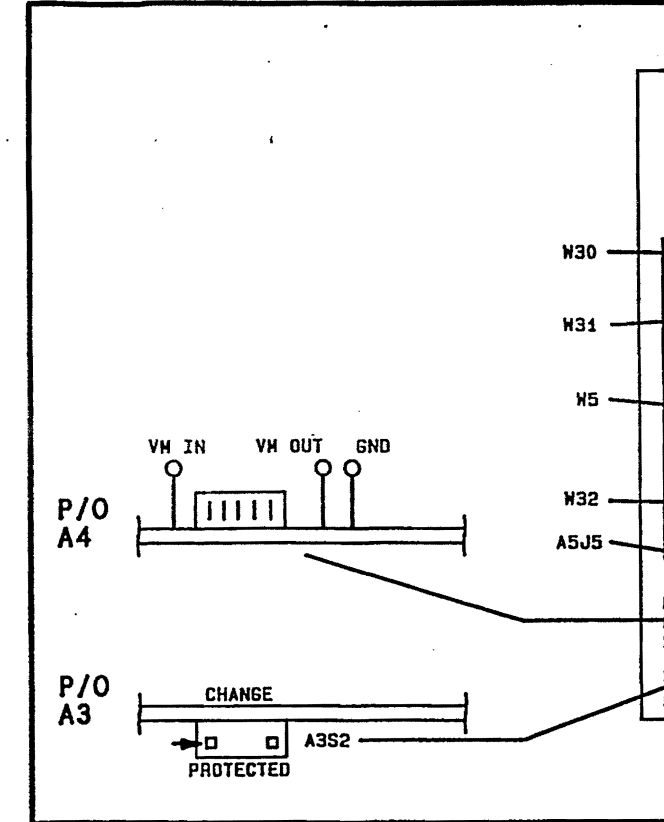



12 INPUTS VERIFICATION

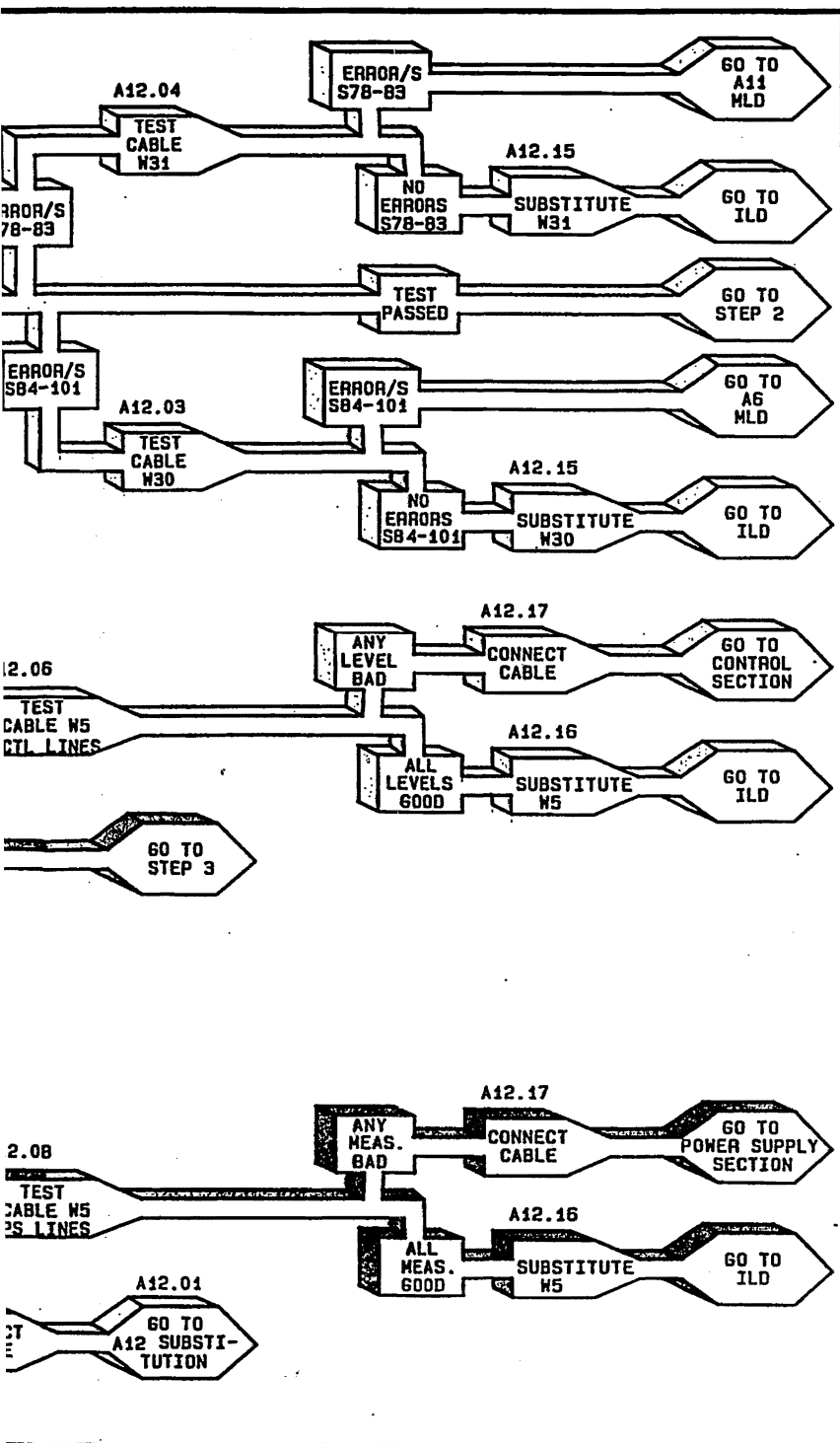

A12 MODULE SUBSTITUTION

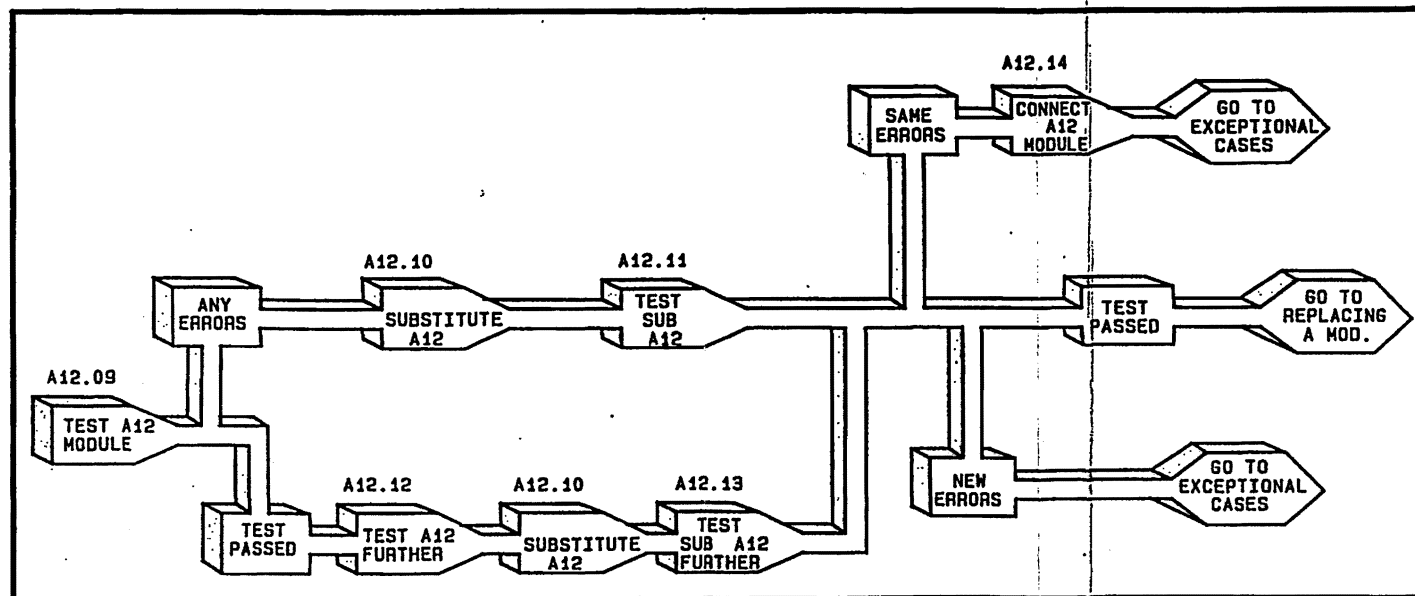

A12 MODULE CABLE CONNECTION LOCATOR

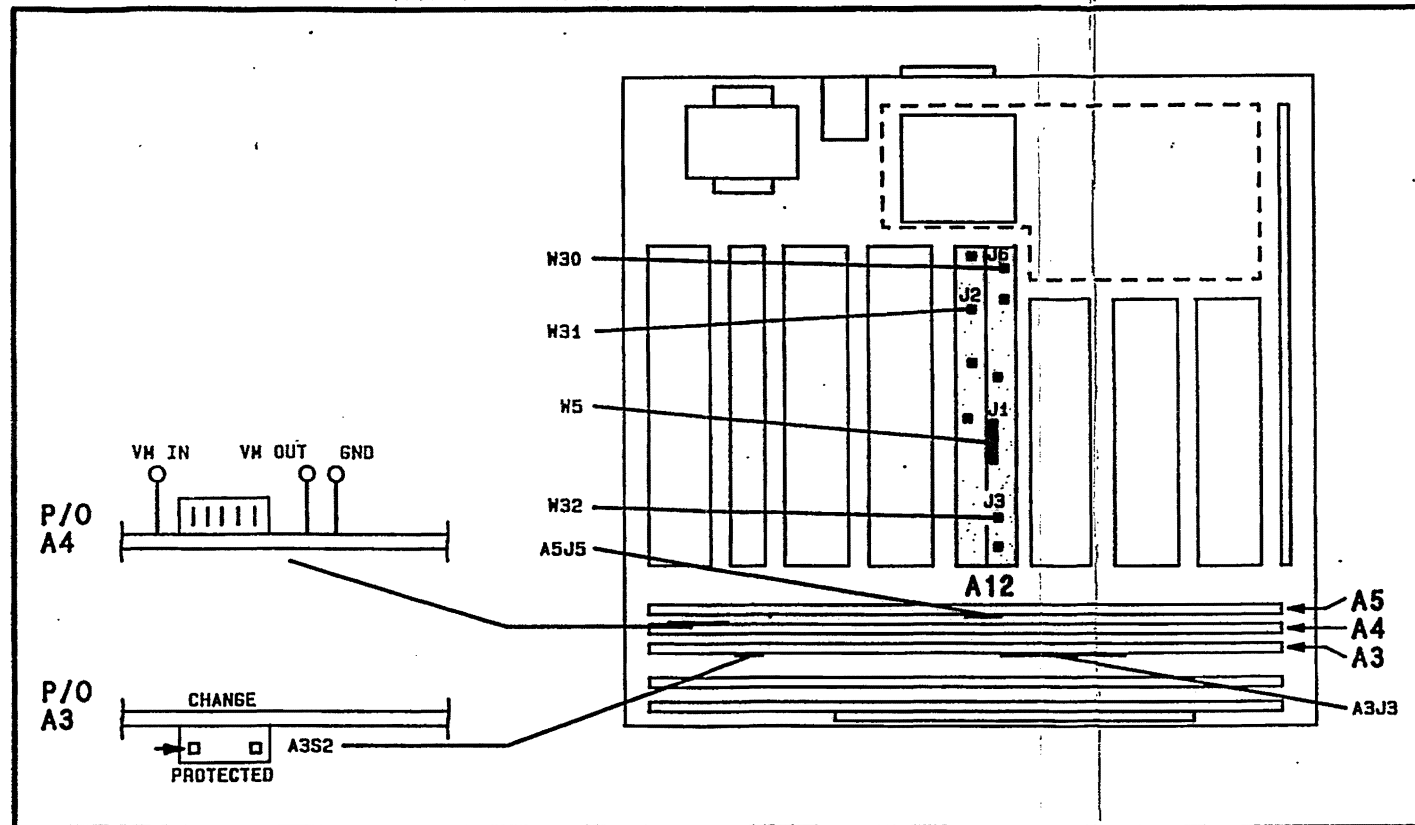

A12 MODULE I/O SIGNALS DIAGRAM

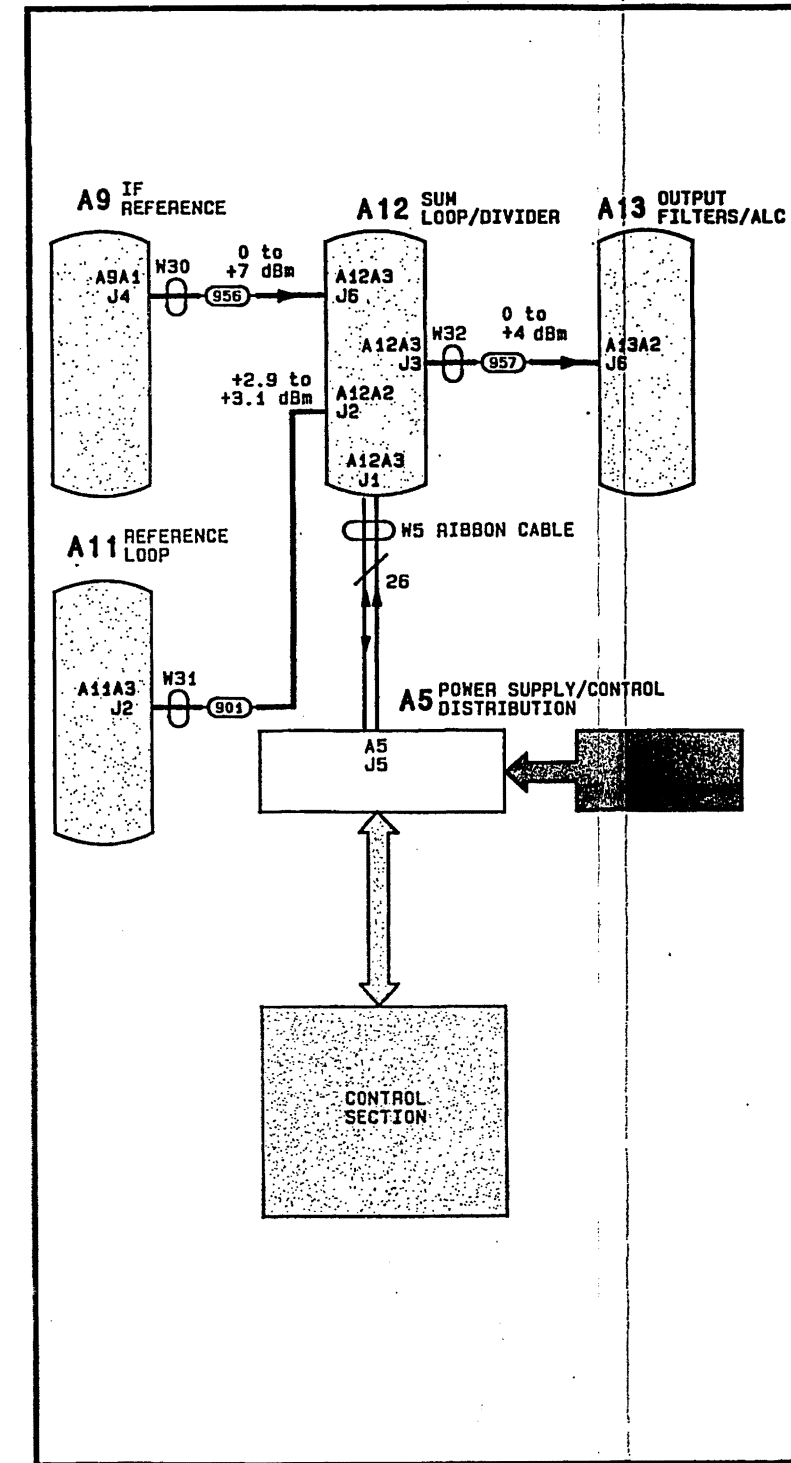
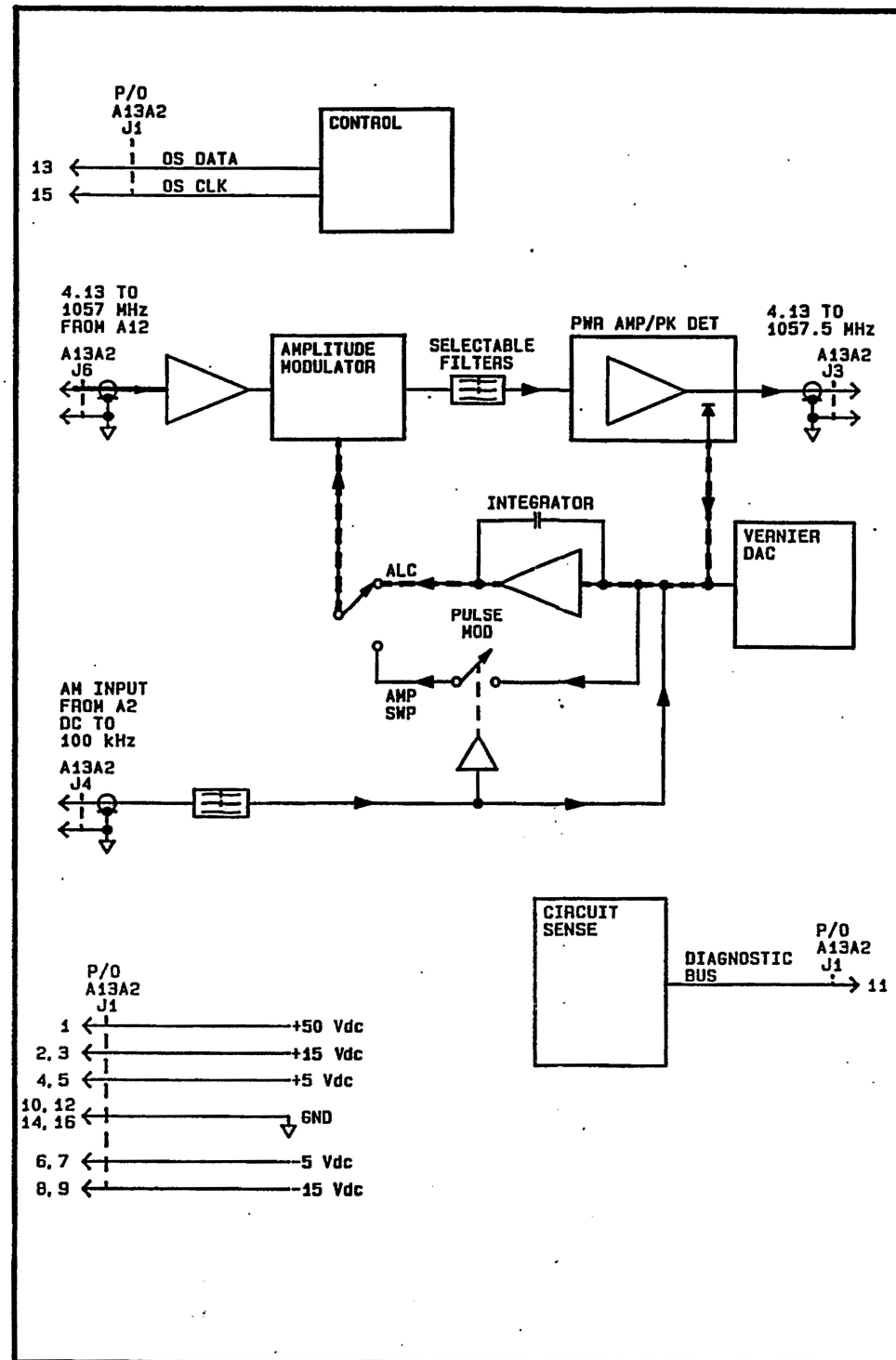
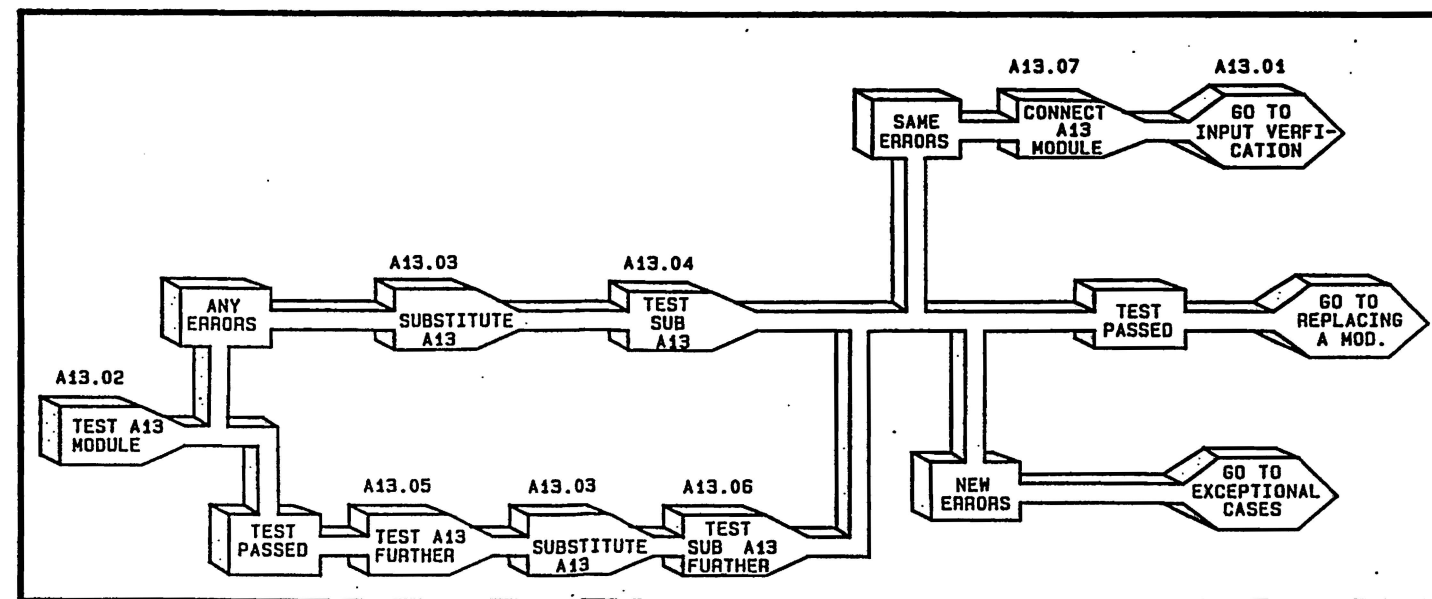

Figure 3J-100. A12 Sum Loop/Divider Module Diagnostics.

A13 MODULE SIMPLIFIED BLOCK DIAGRAM



A13 MODULE SUBSTITUTION



A13 MODULE CABLE CONNECTION LOCATOR

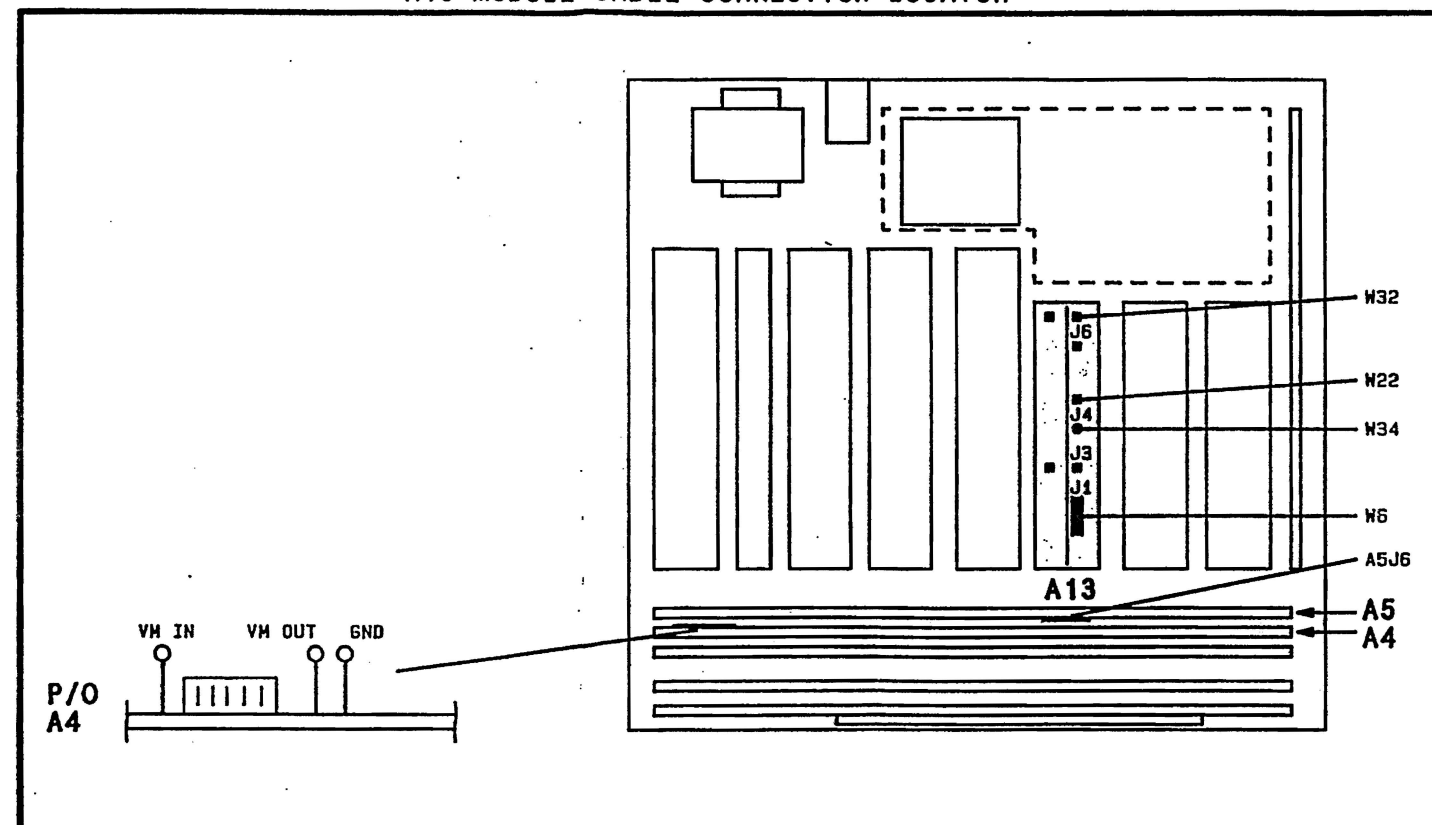

A13 INPUTS

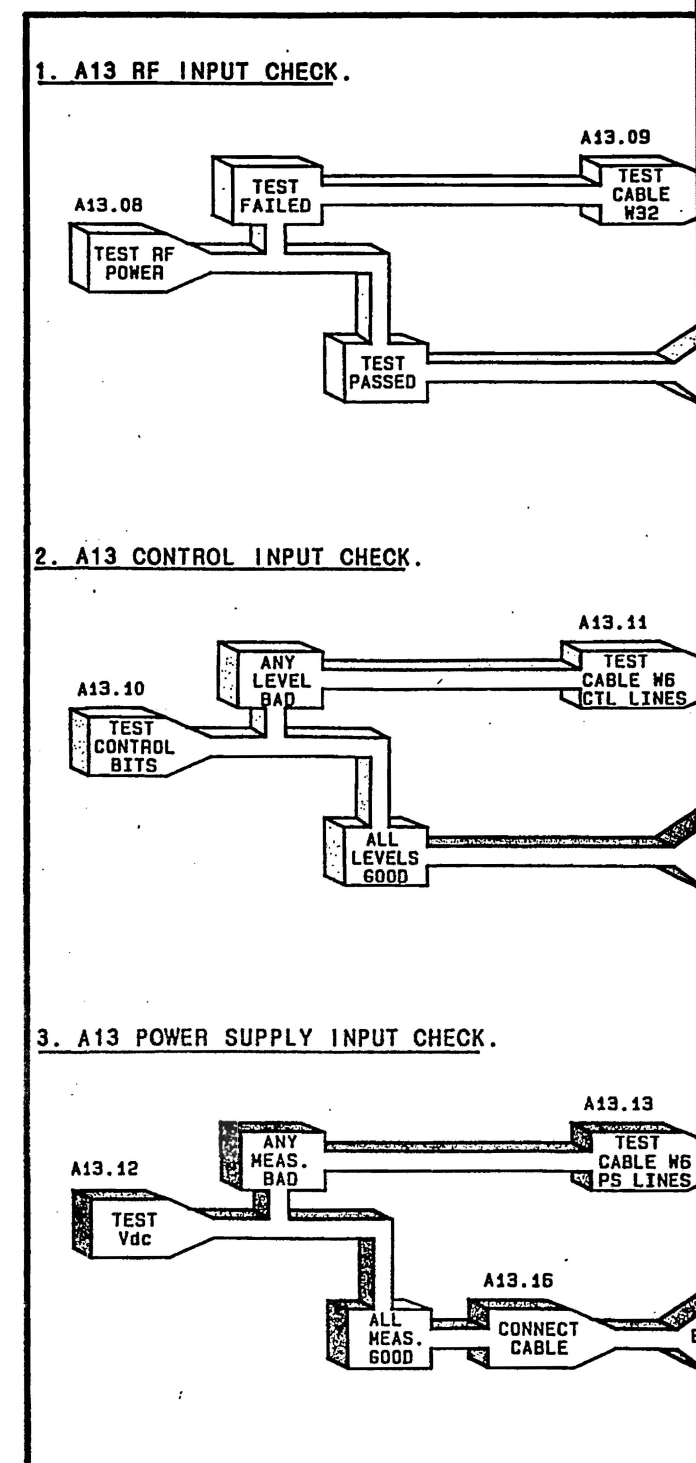

ITUTION

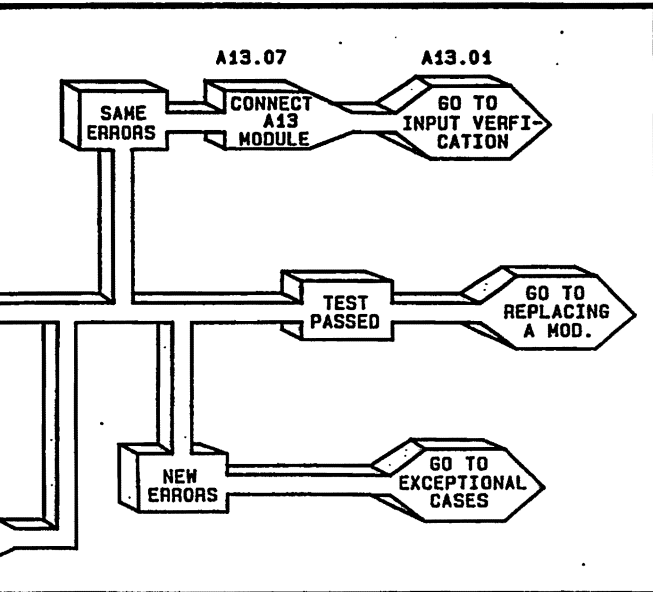

CTION LOCATOR

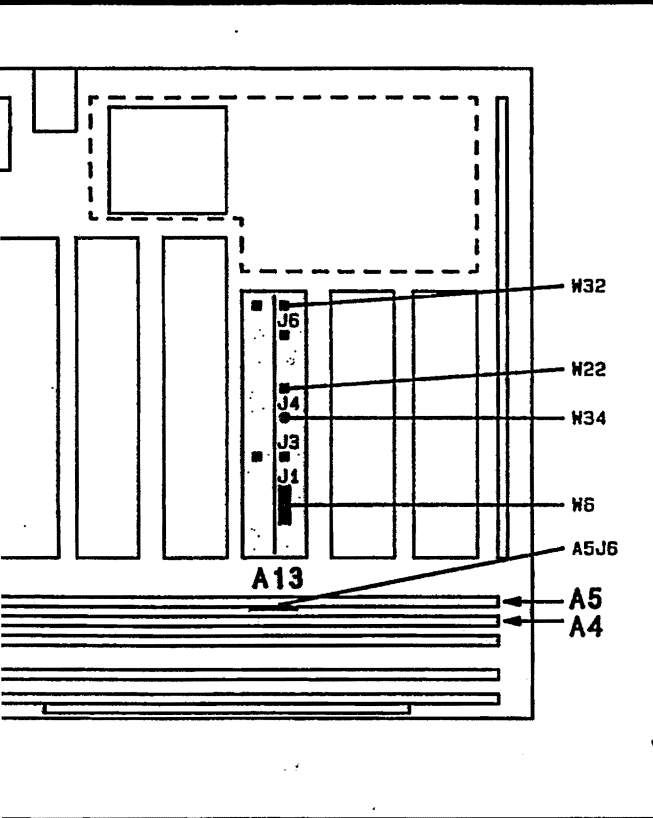

A13 INPUTS VERIFICATION

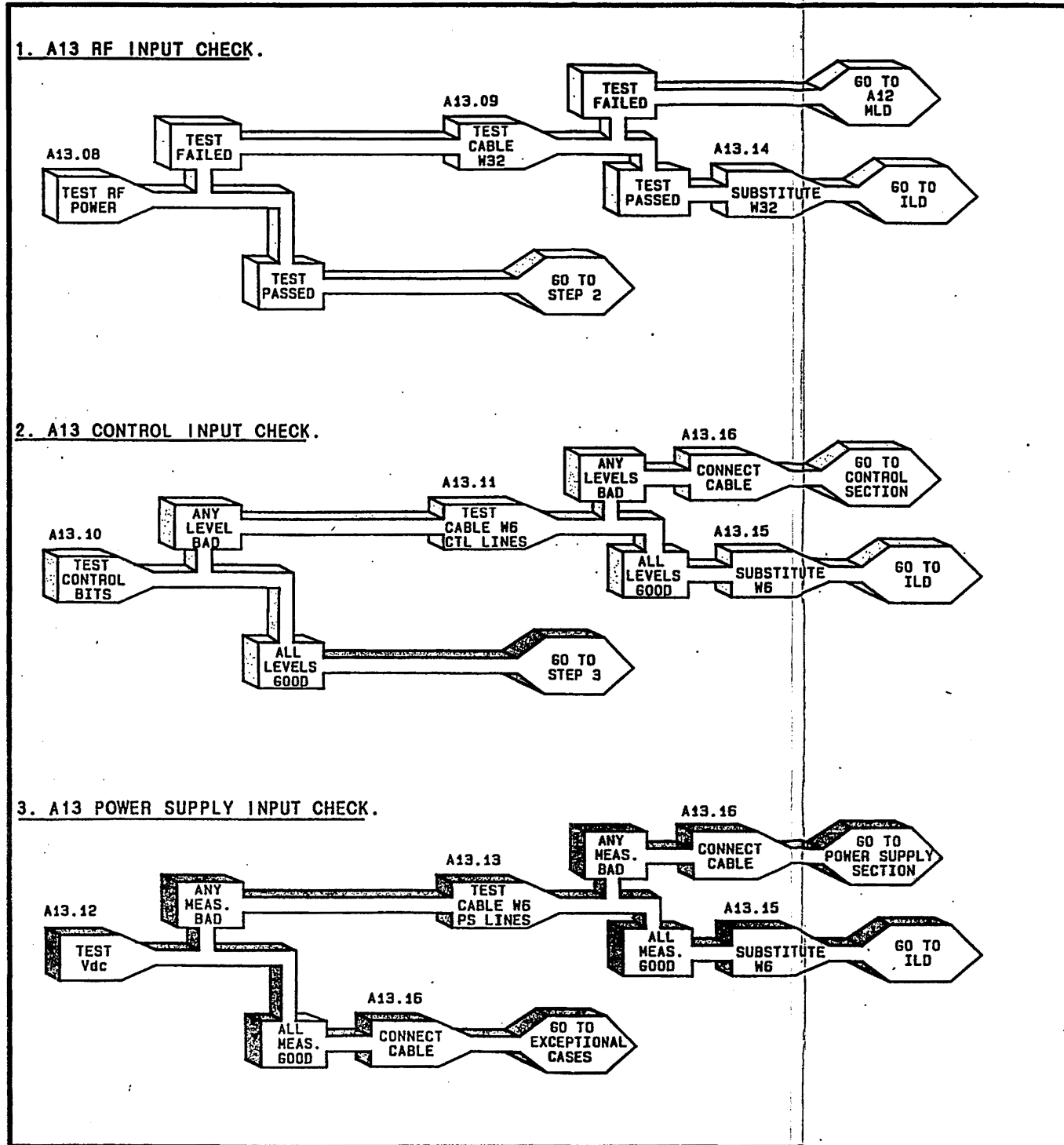

A13 MODULE I/O SIGNALS DIAGRAM

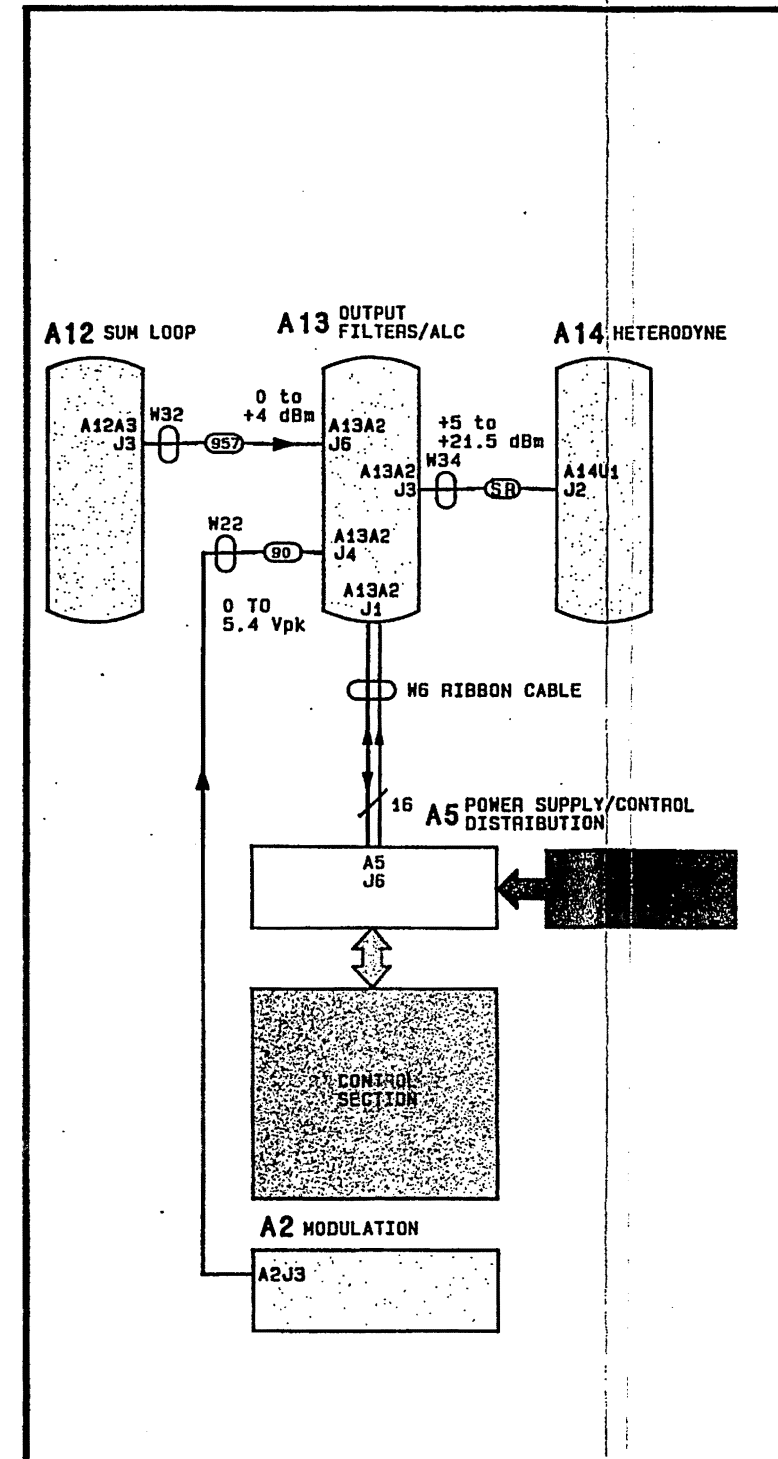
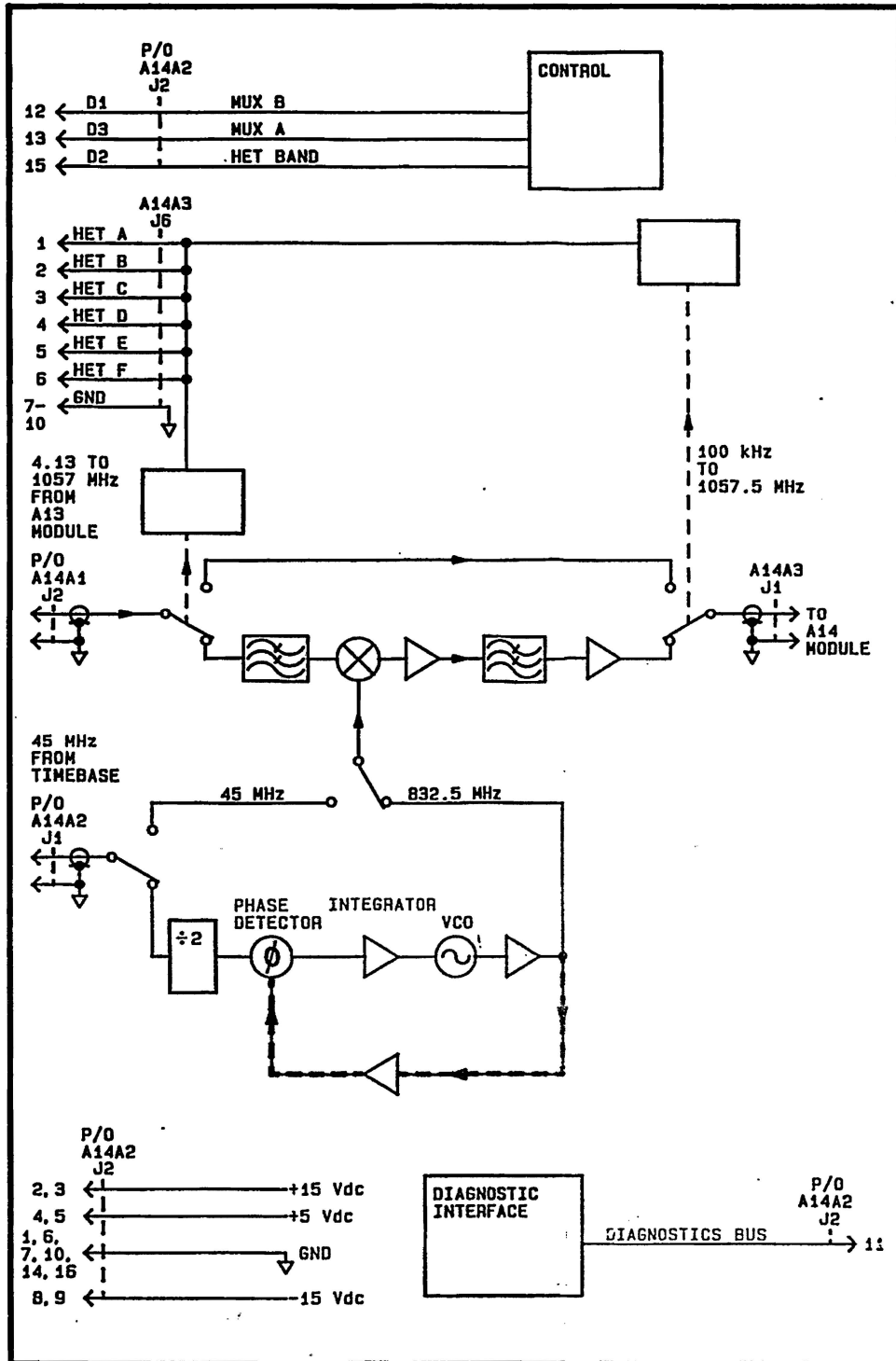
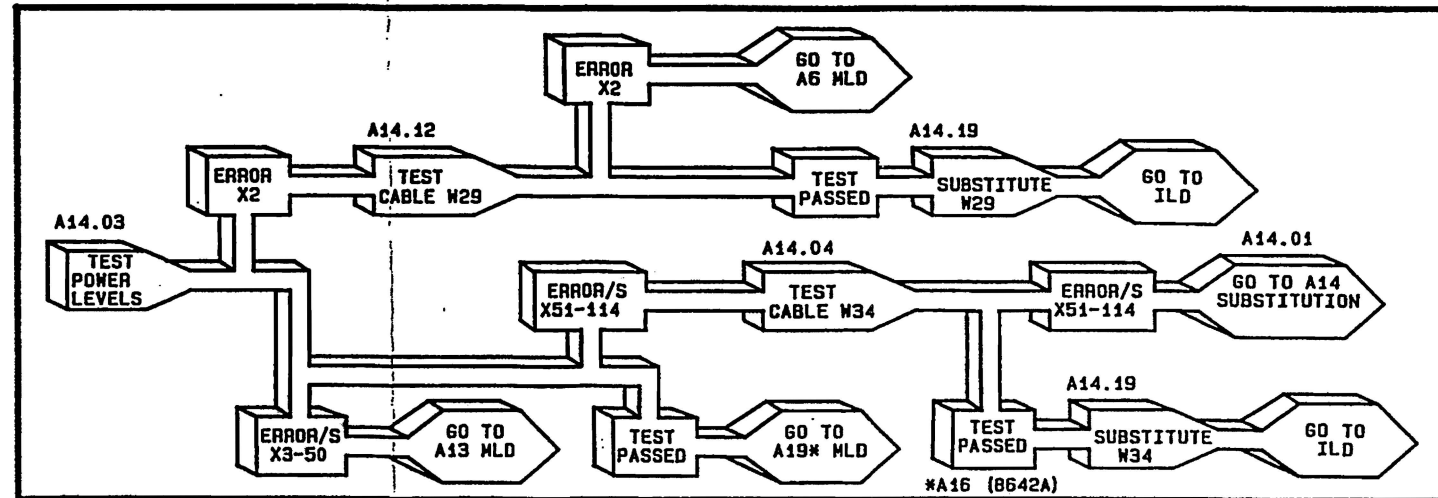

Figure 3K-100. A13 Output Filters/ALC Module Diagnostics.

**A14 MODULE SIMPLIFIED BLOCK DIAGRAM**



**A14 RF POWER LEVEL DIAGNOSTICS**



**A14 MODULE SUBSTITUTION**

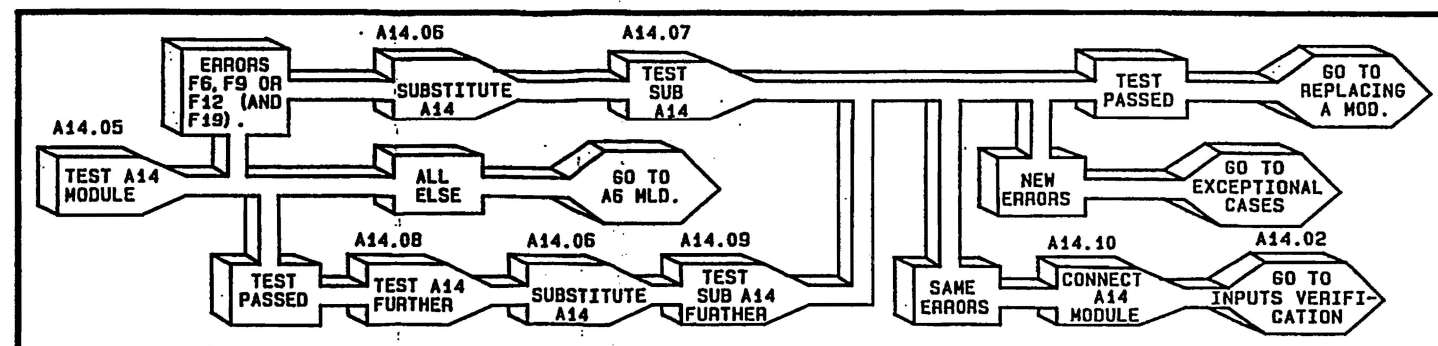

**A14 MODULE CABLE CONNECTION LOCATOR**

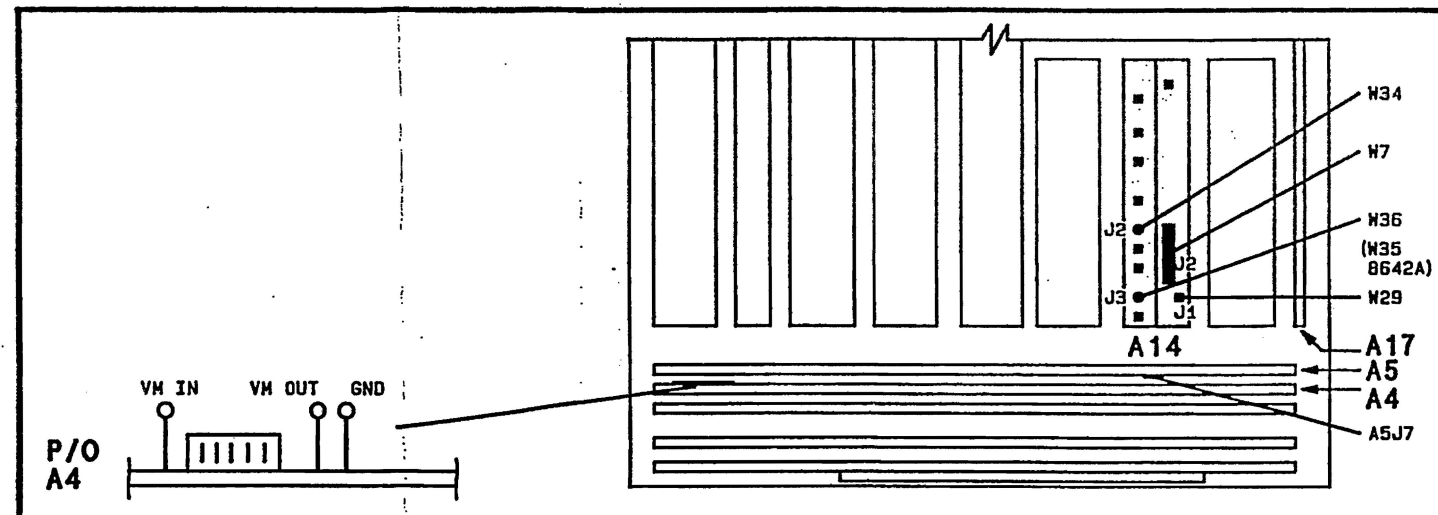

**A14 INPUTS VERIFICATION**

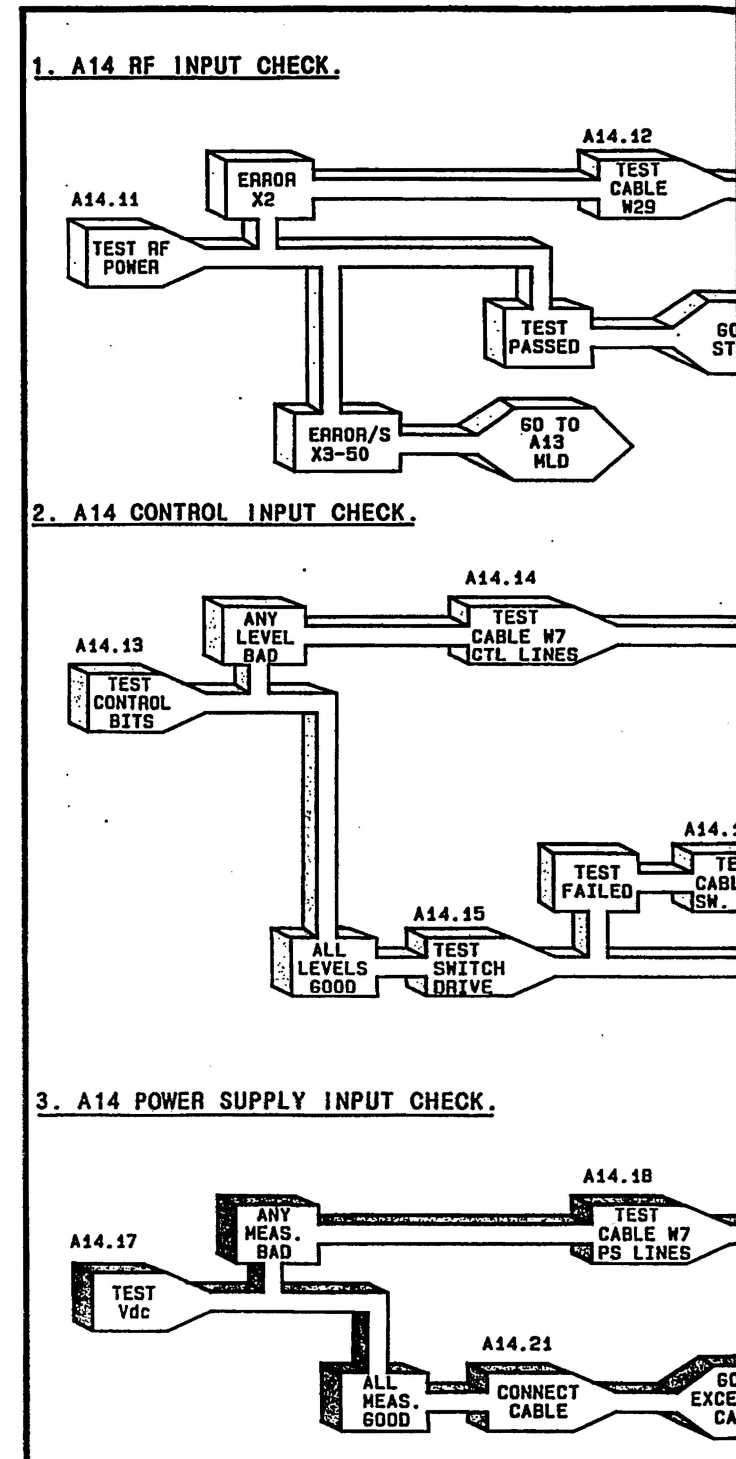

EL DIAGNOSTICS

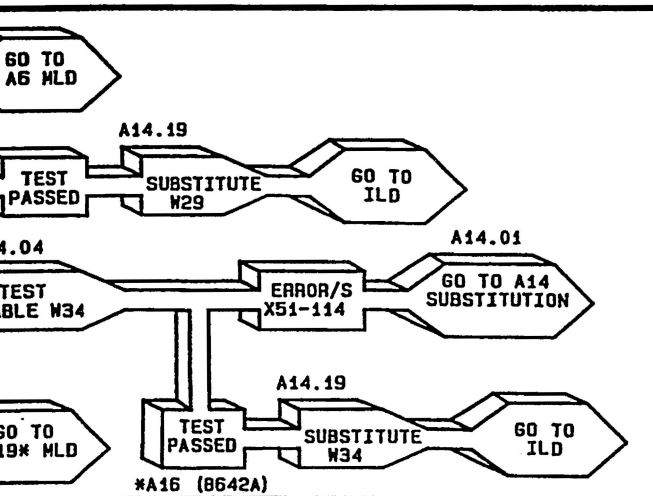

STITUTION

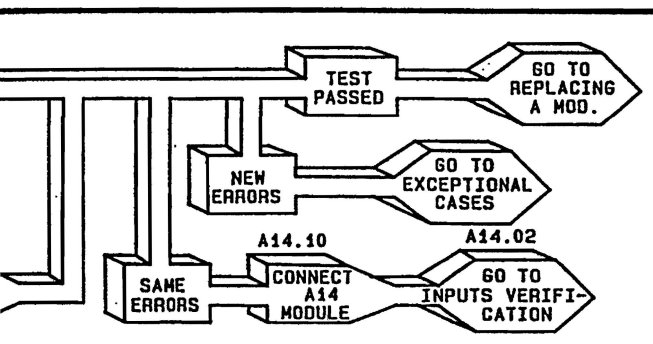

SECTION LOCATOR

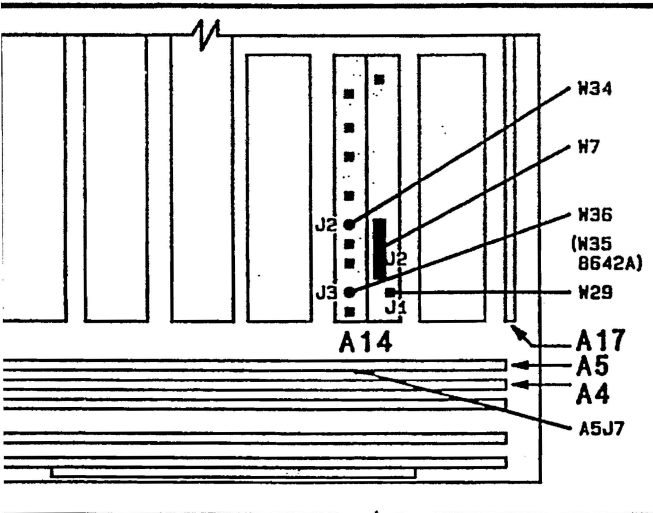

A14 INPUTS VERIFICATION

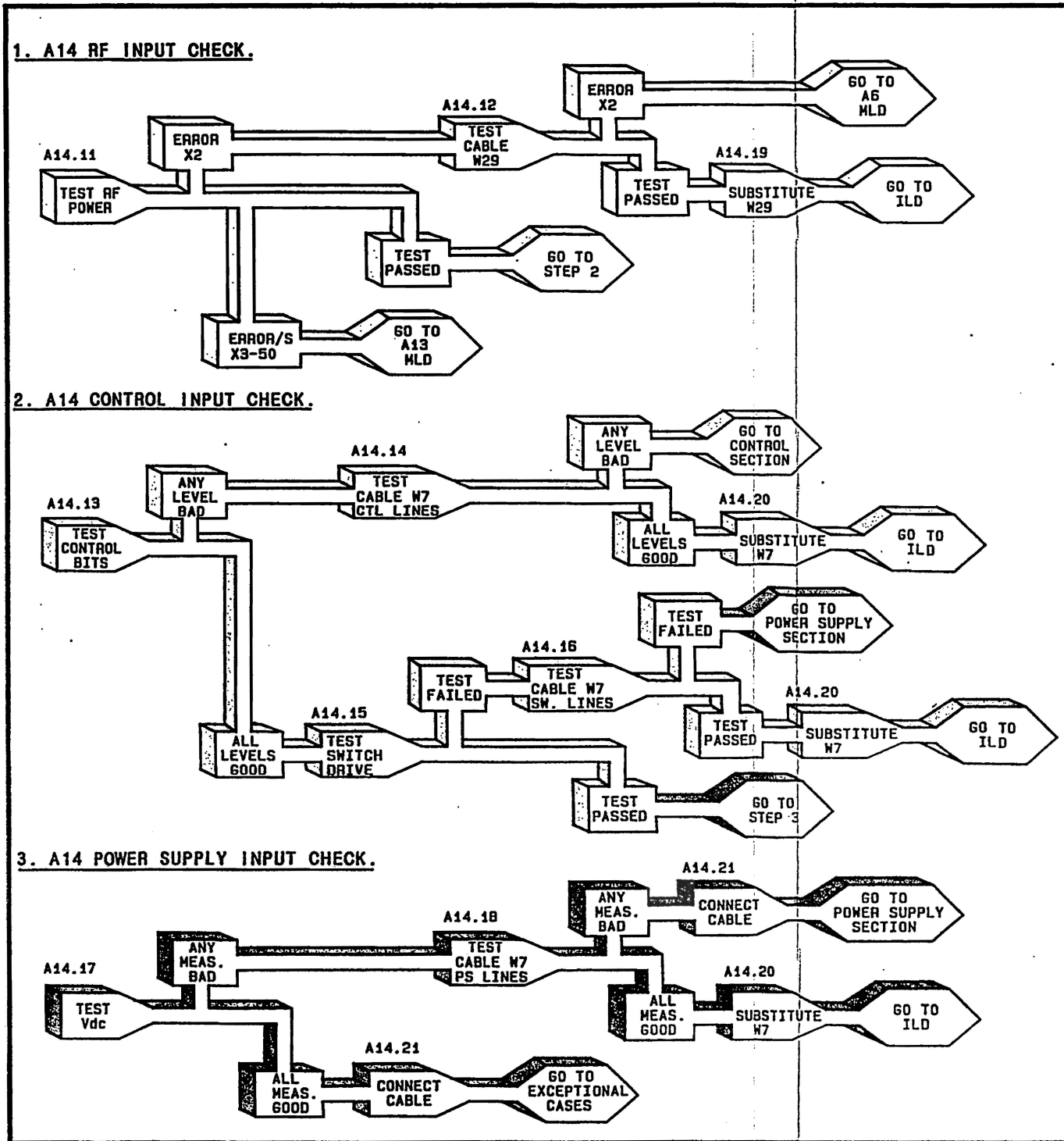

A14 MODULE I/O SIGNALS DIAGRAM

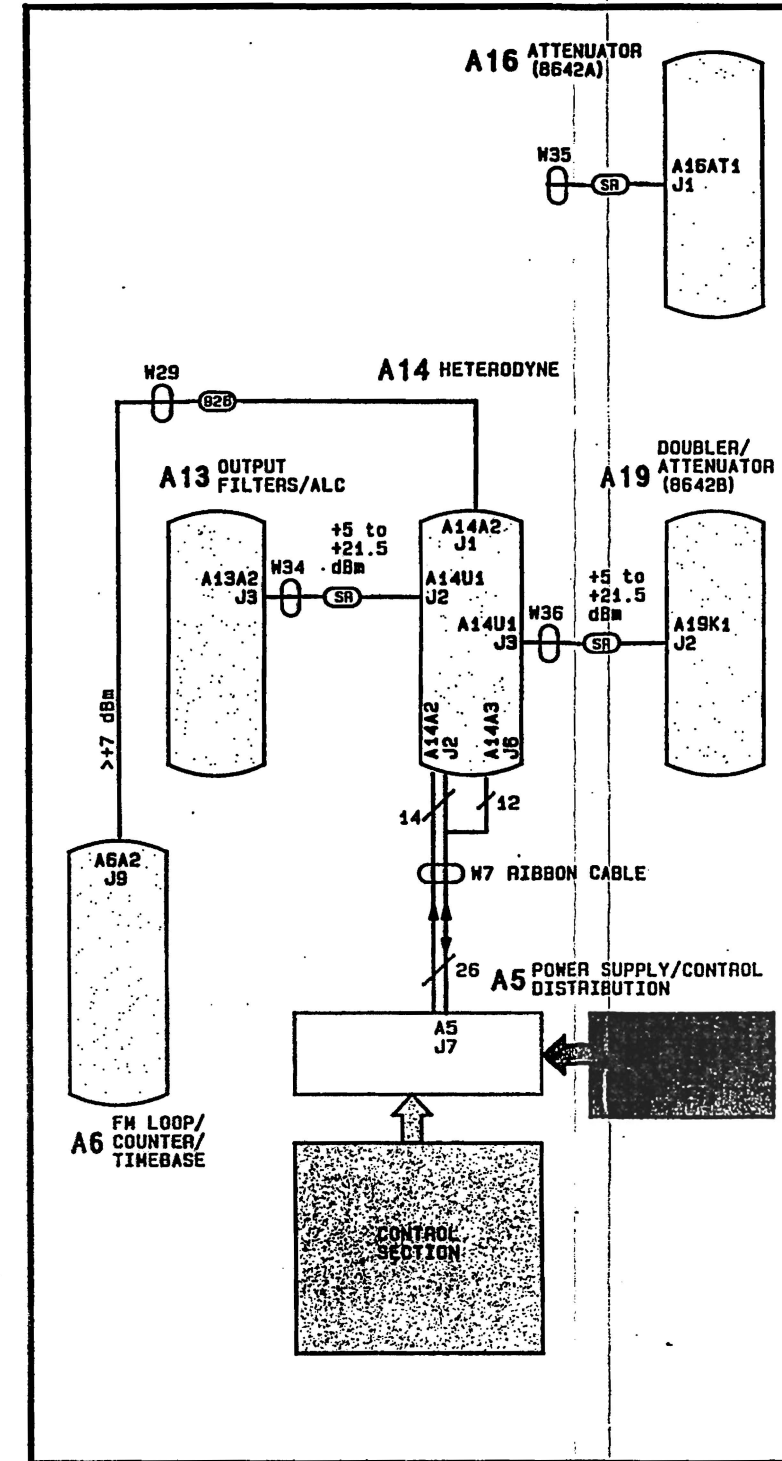
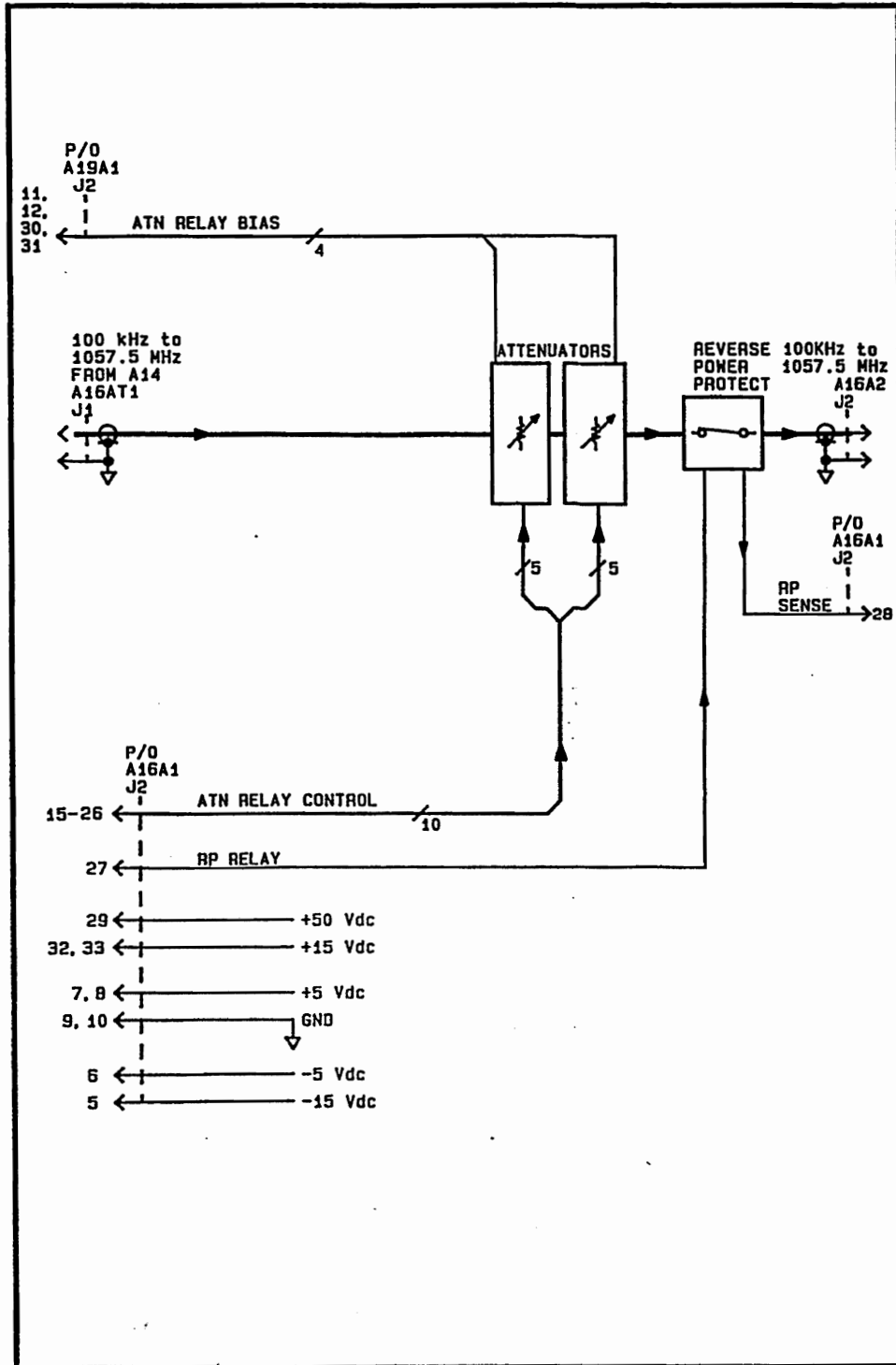
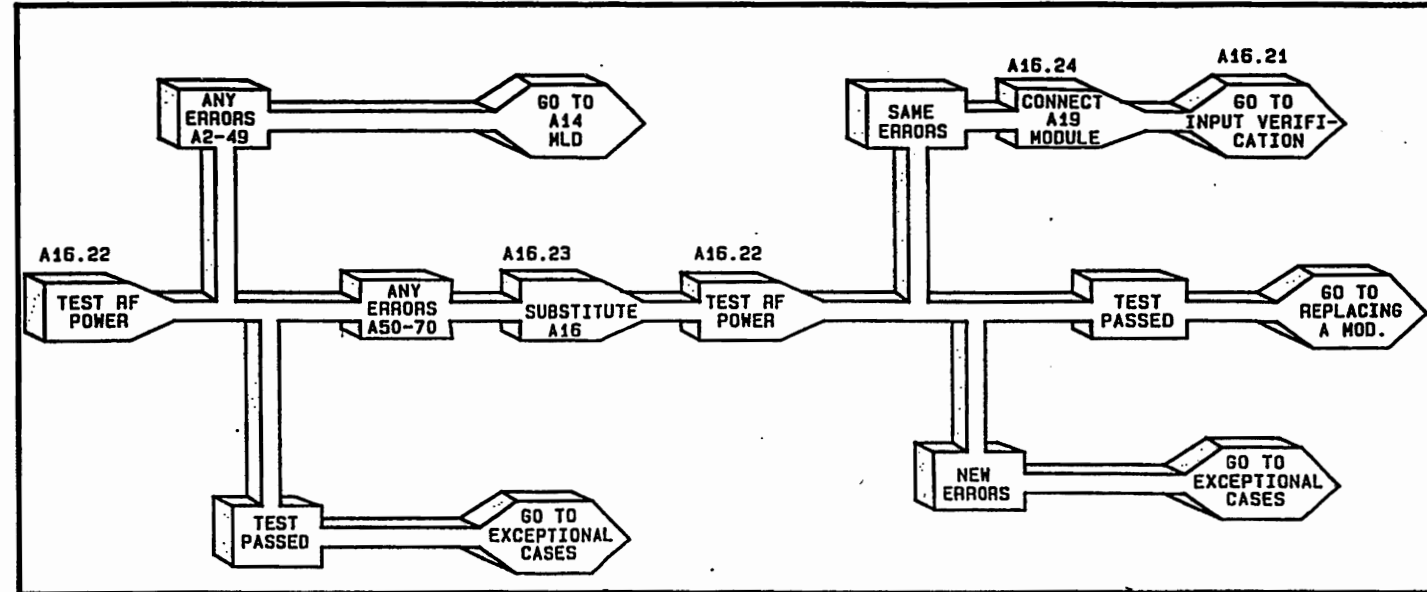

Figure 3L-100. A14 Heterodyne Module Diagnostics.

A16 (OPTION 003) MODULE SIMPLIFIED BLOCK DIAGRAM



A16 (OPTION 003) MODULE SUBSTITUTION



A16 (OPTION 003) MODULE CABLE CONNECTION LOCATOR

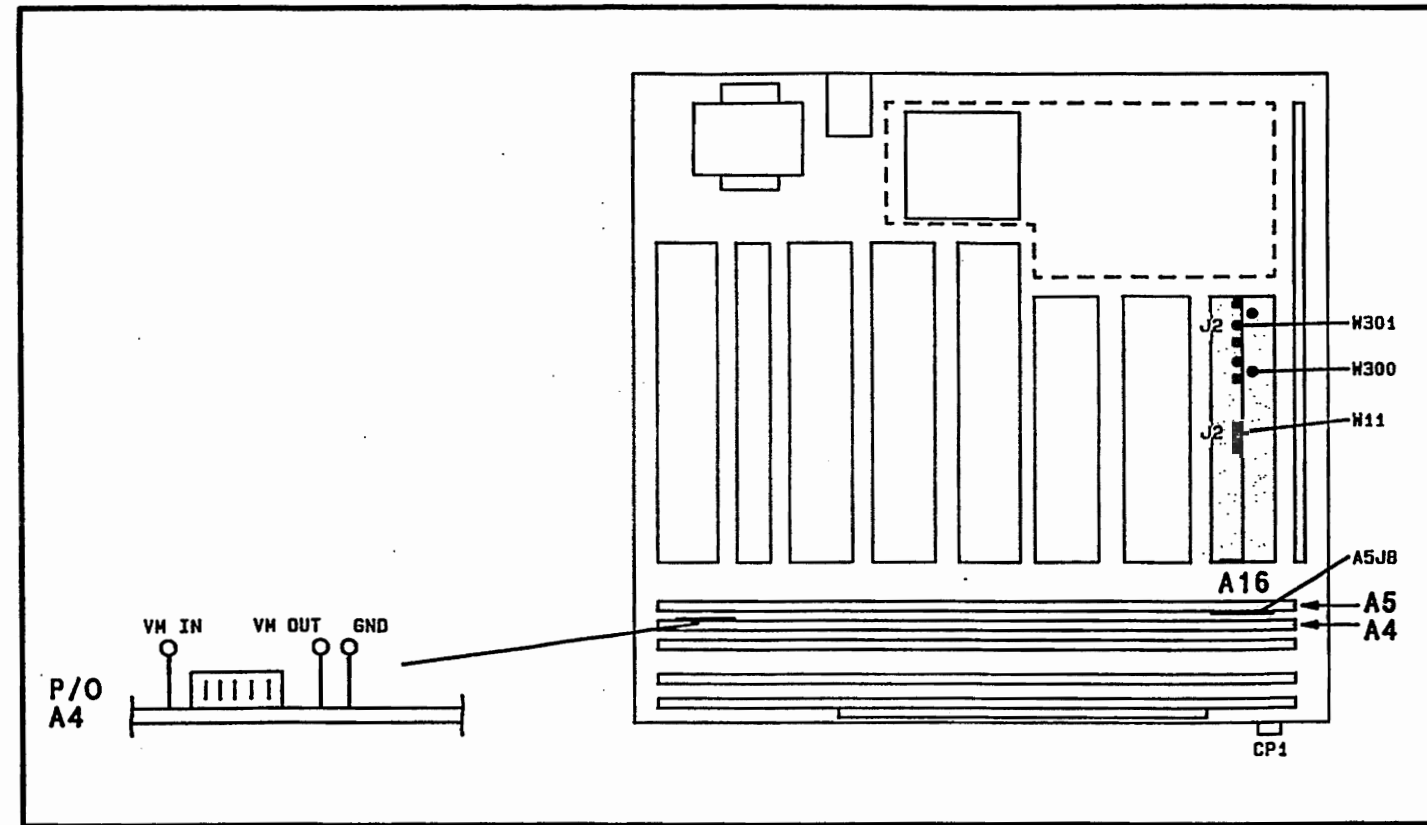

A16 (OPTION 003)

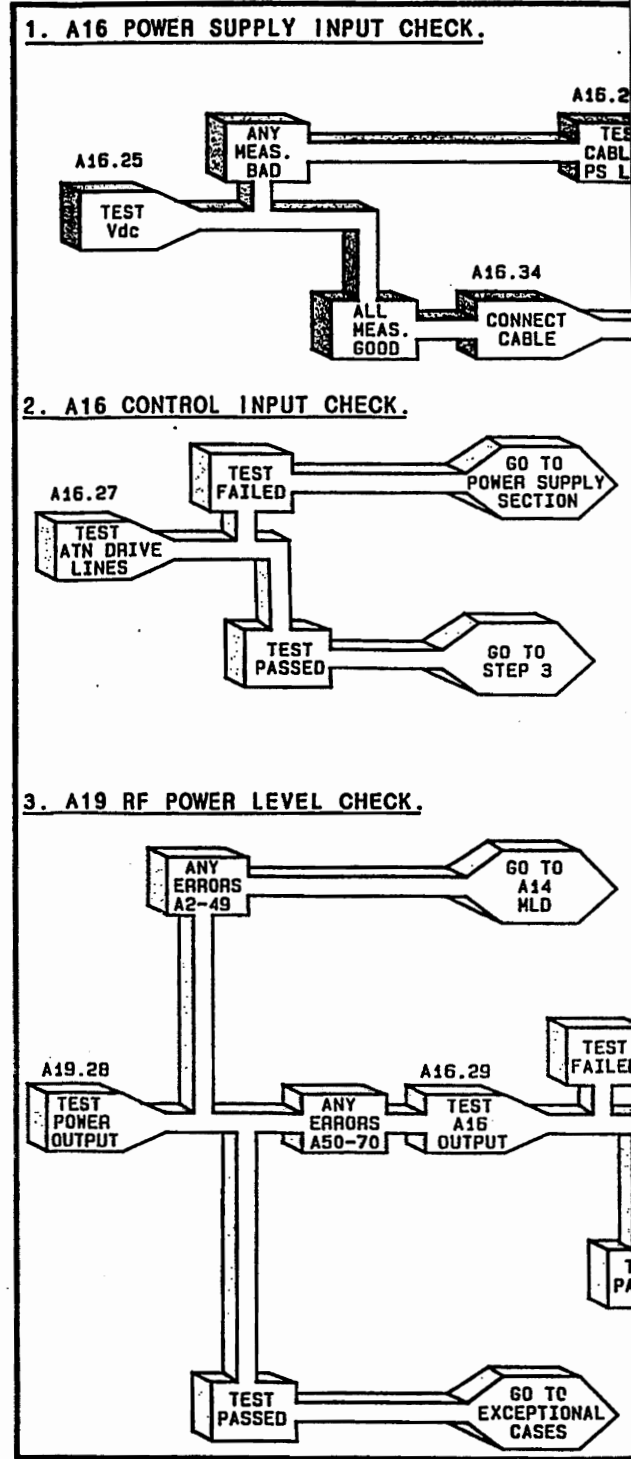

03) MODULE SUBSTITUTION

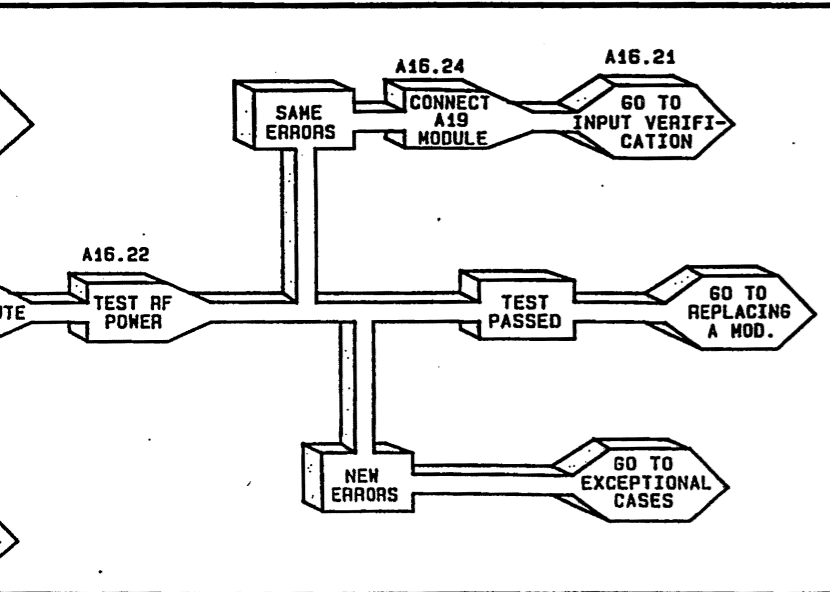

MODULE CABLE CONNECTION LOCATOR

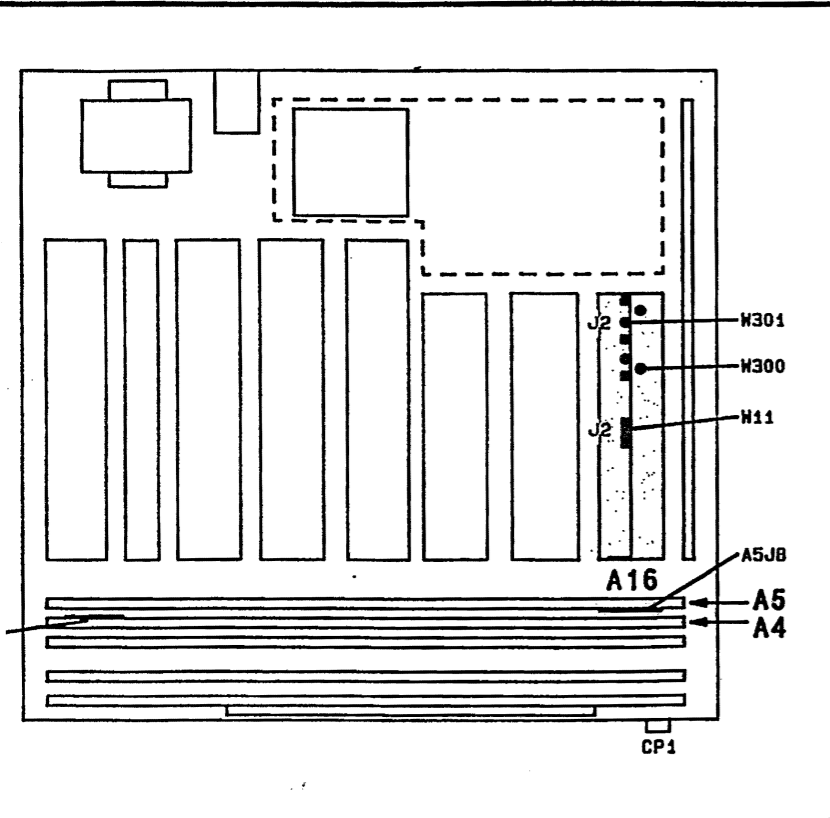

A16 (OPTION 003) INPUTS VERIFICATION

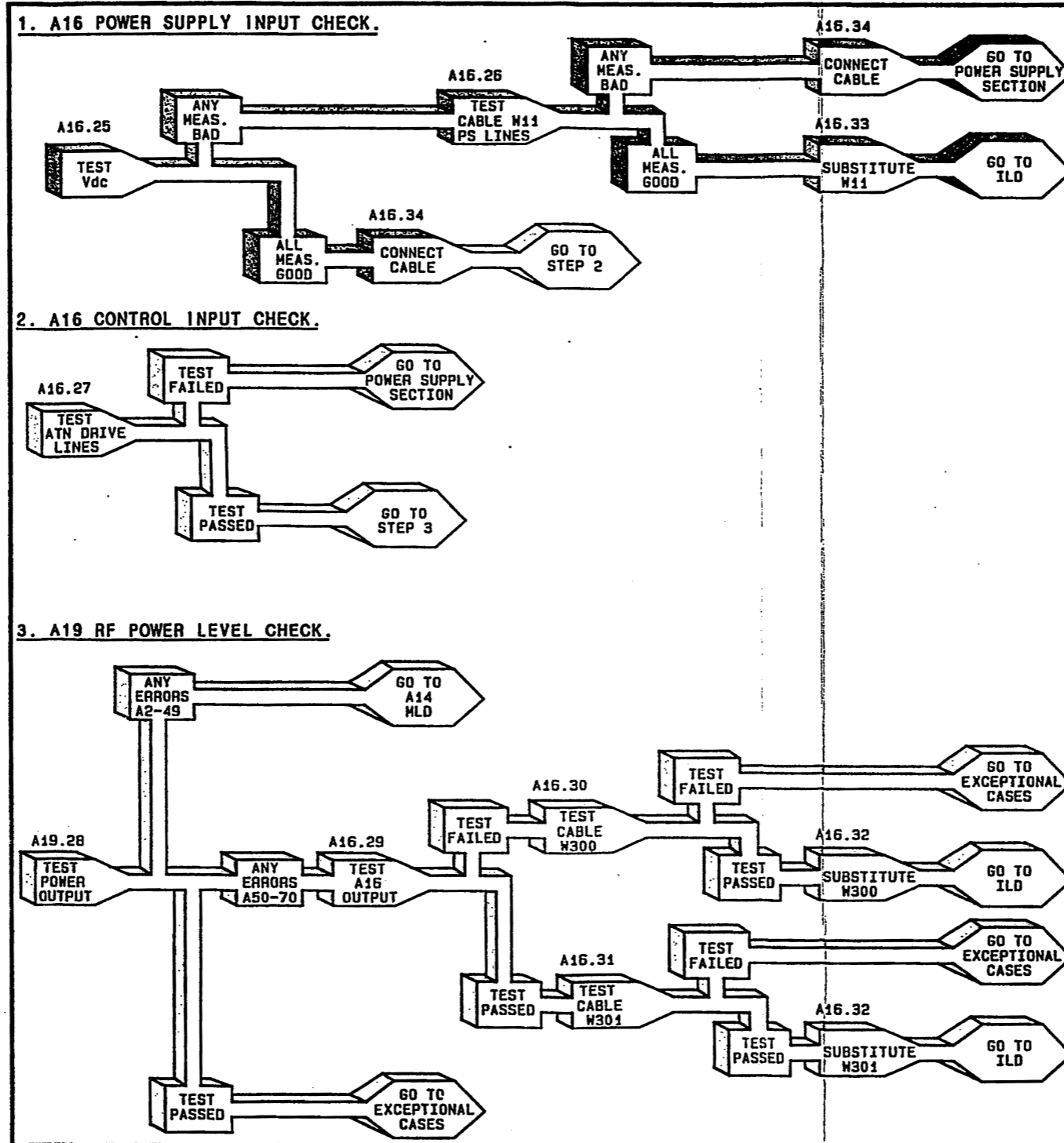

A16 (OPTION 003) MODULE I/O SIGNALS DIAGRAM

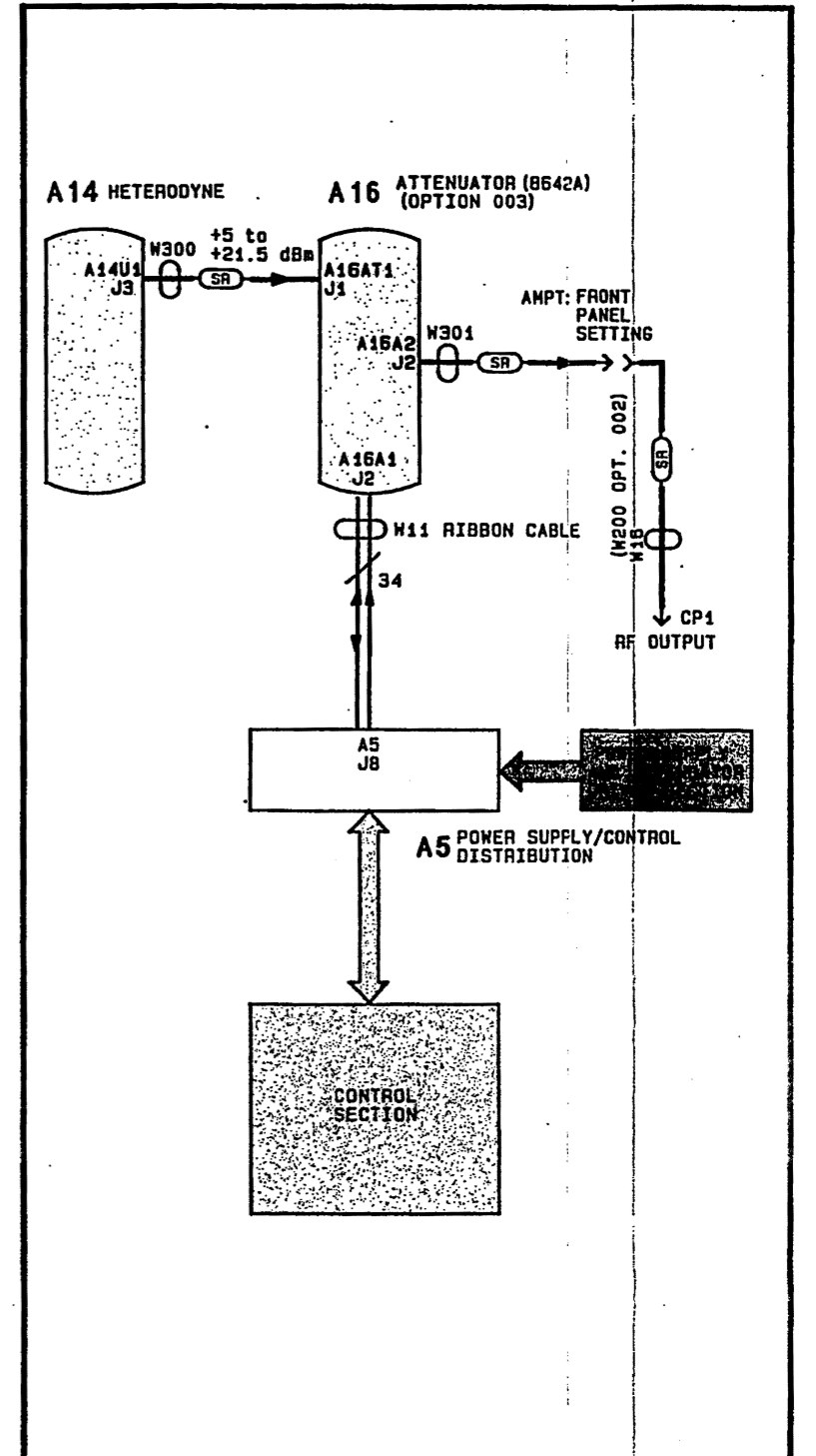
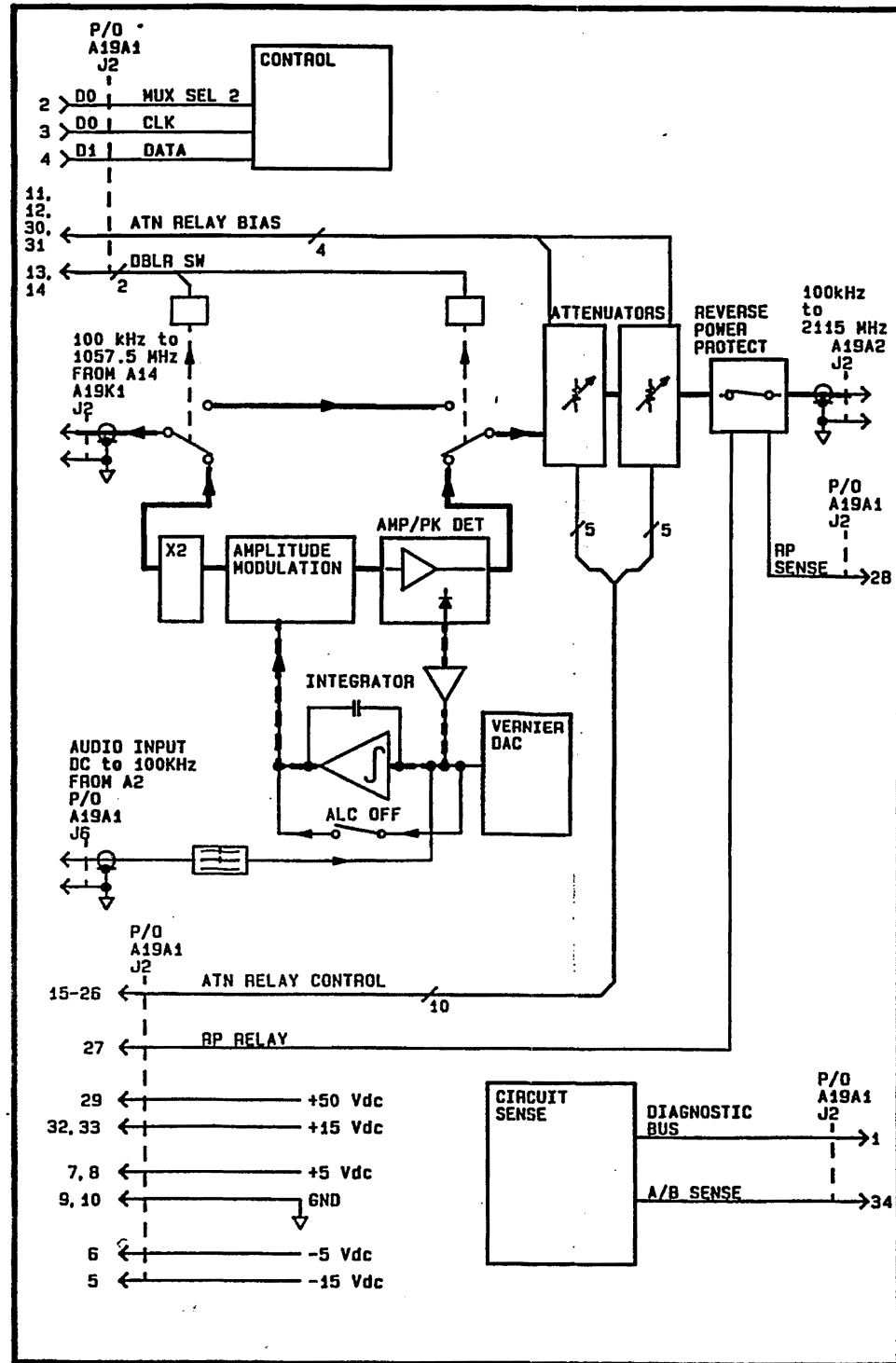
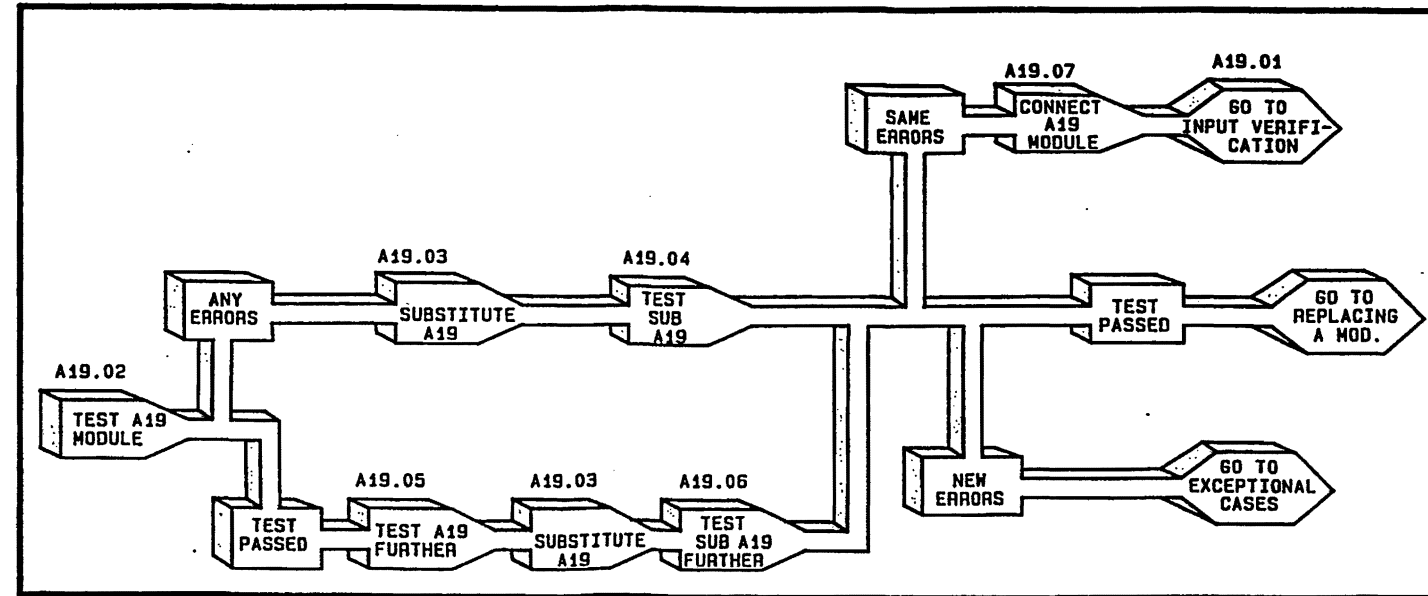

Figure 3M-100. A16 (Option 003) Attenuator Module Diagnostics.

A19 MODULE SIMPLIFIED BLOCK DIAGRAM



A19 MODULE SUBSTITUTION



A19 MODULE CABLE CONNECTION LOCATOR

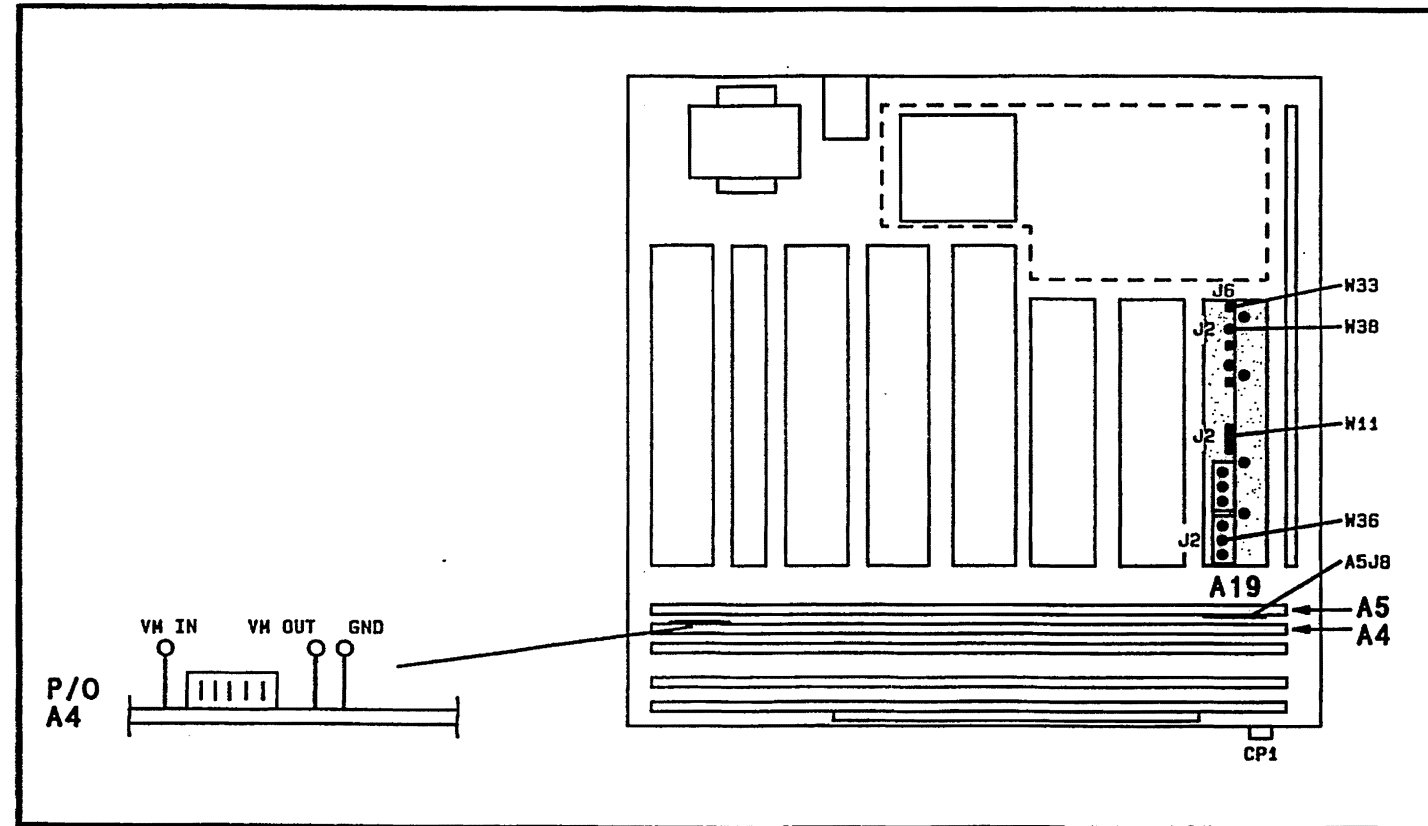

A19 INPUTS

1. A19 POWER SUPPLY INPUT CHECK.

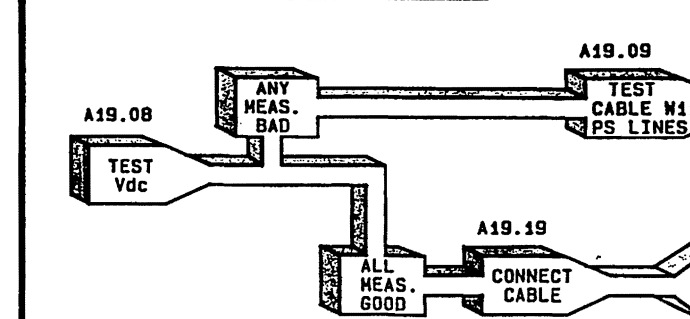

2. A19 CONTROL INPUT CHECK.

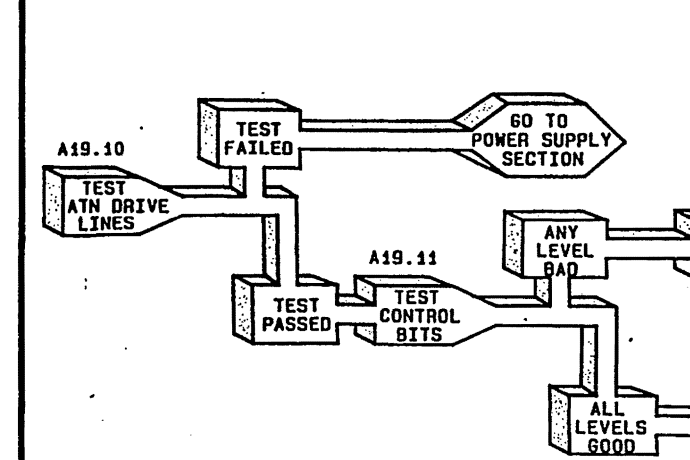

3. A19 RF POWER LEVEL CHECK.

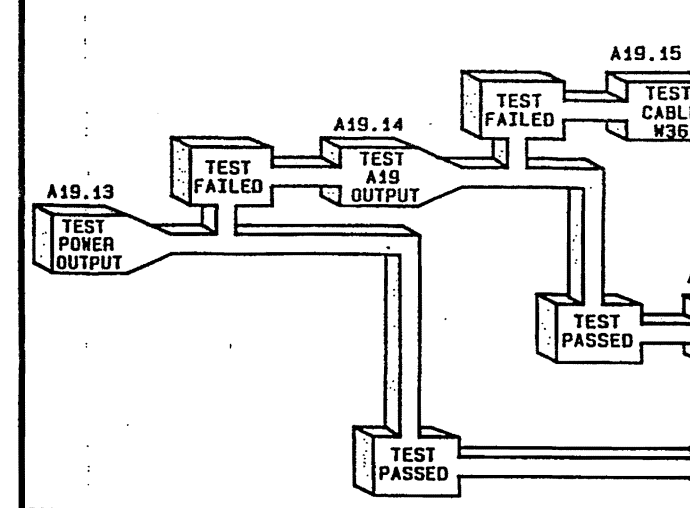



ITUTION

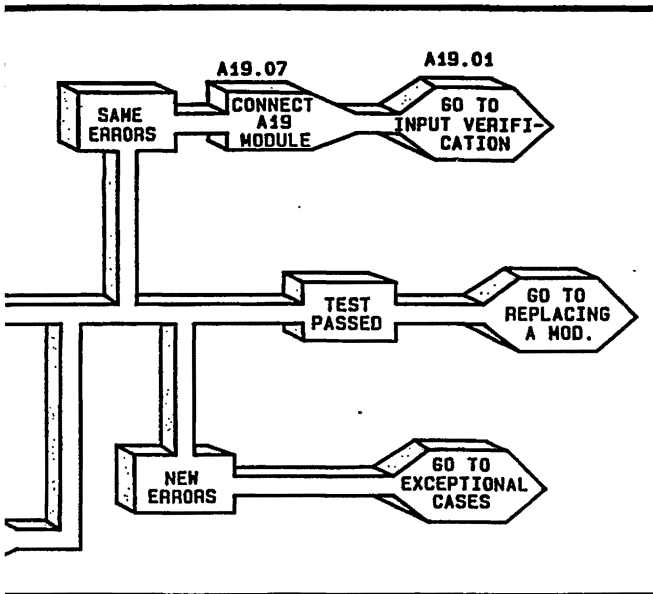

LOCATION LOCATOR

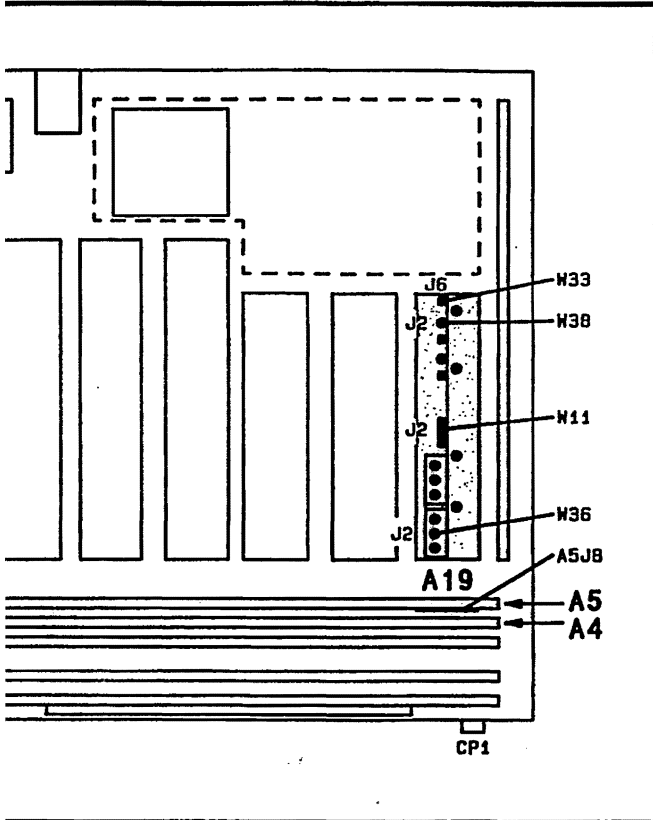

A19 INPUTS VERIFICATION

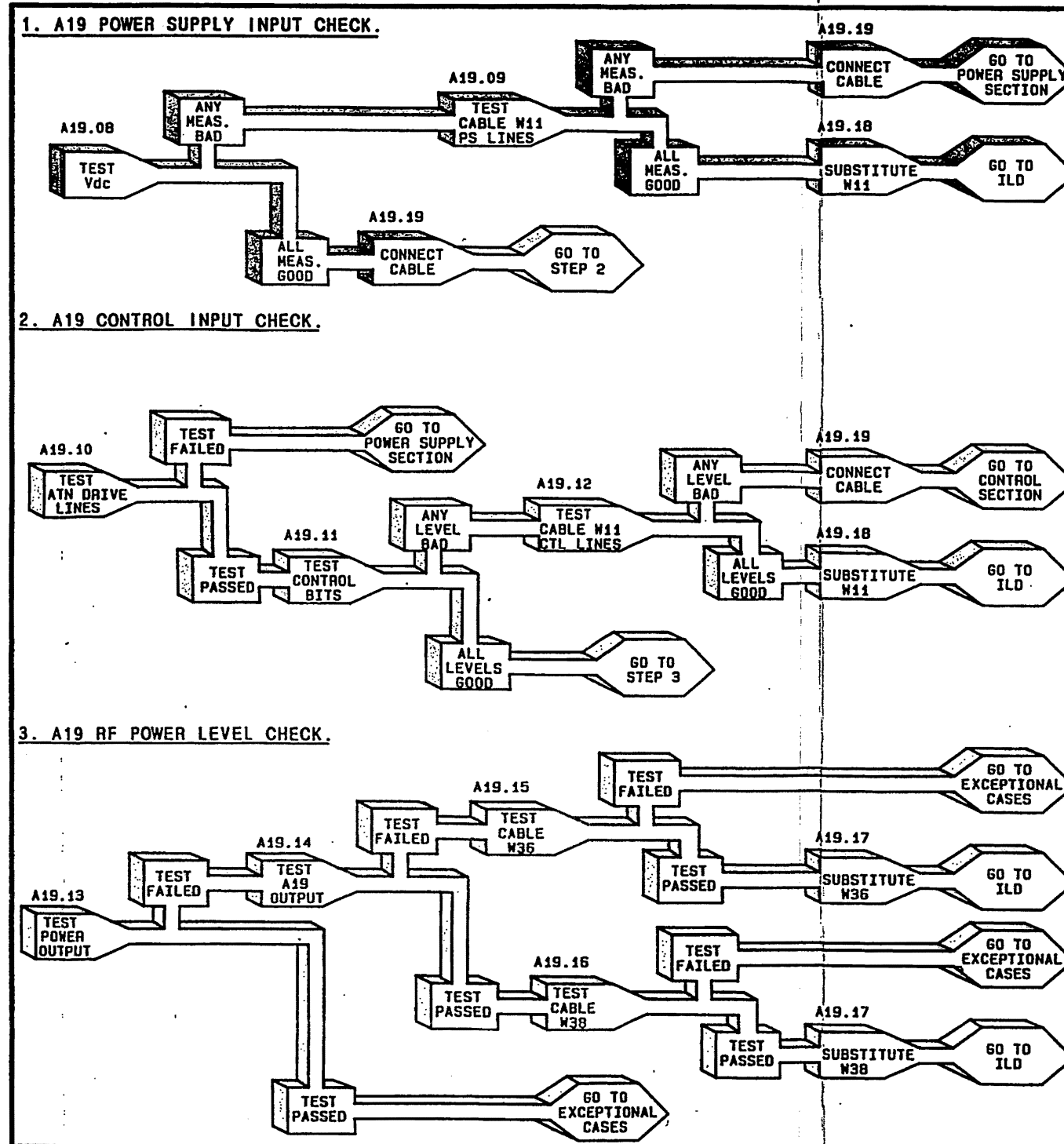

A19 MODULE I/O SIGNALS DIAGRAM

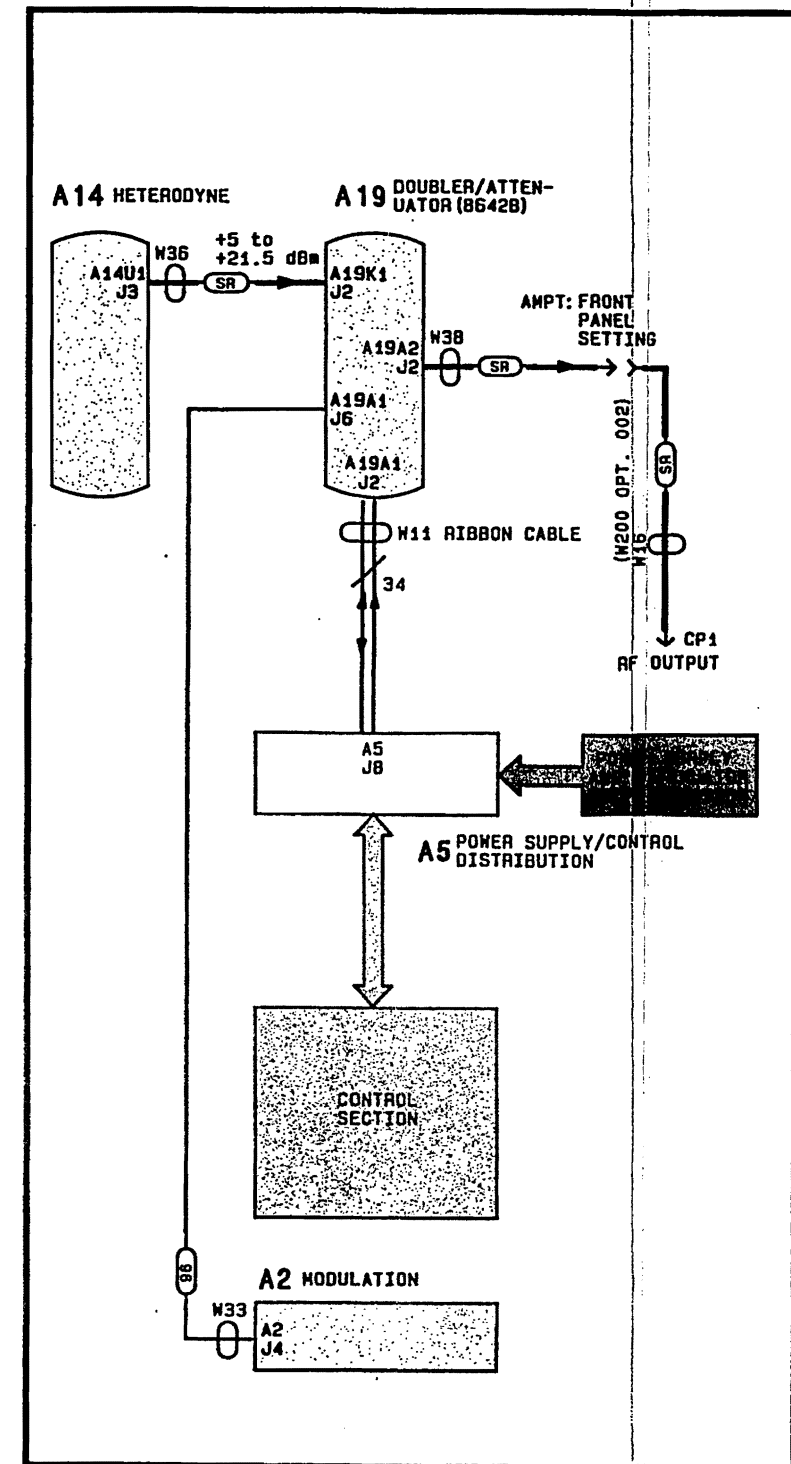
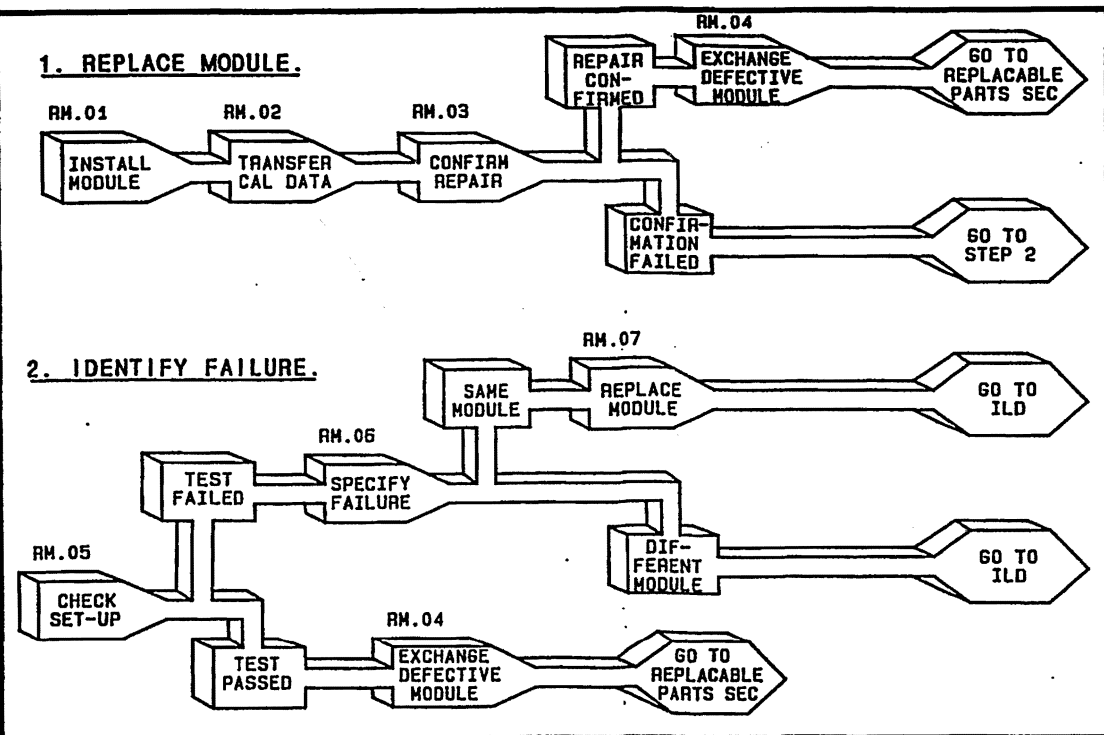

Figure 3N-100. A19 Doubler/Attenuator Module Diagnostics.

### MODULE REPLACEMENT



### CAL DATA TRANSFER TABLE

Modules	Cal Data Select Keys
A1 Keyboard/LCD Display Module	No Data Required
A2 Modulation Module	9 HZ
A3 Processor/Memory Module	7 5 9
A4 Latch Module	No Data Required
A6 FM Loop/Counter/Timebase Module	3 HZ
A7 SAMR Loop Module	No Data Required
A8 10 MHz High Stability Timebase Assembly (Opt. 001)	No Data Required
A9 IF Loop Module	No Data Required
A11 Reference Loop Module	1 HZ
A12 Sum Loop/Divider Module	2 HZ
A13 Output Filters/ALC Module	4 HZ
A14 Heterodyne Module	8 HZ
A16 Attenuator Module (8642A Only)	6 HZ
A17 Power Supply Regulators/Attenuator Drivers Module	No Data Required
A18 Power Supply Rectifier/Filters Module	No Data Required
A19 Doubler/Attenuator Module (8642B Only)	5 HZ
RPP Reverse Power Protection	7 HZ

### INSTRUMENT WIRING DIAGRAM

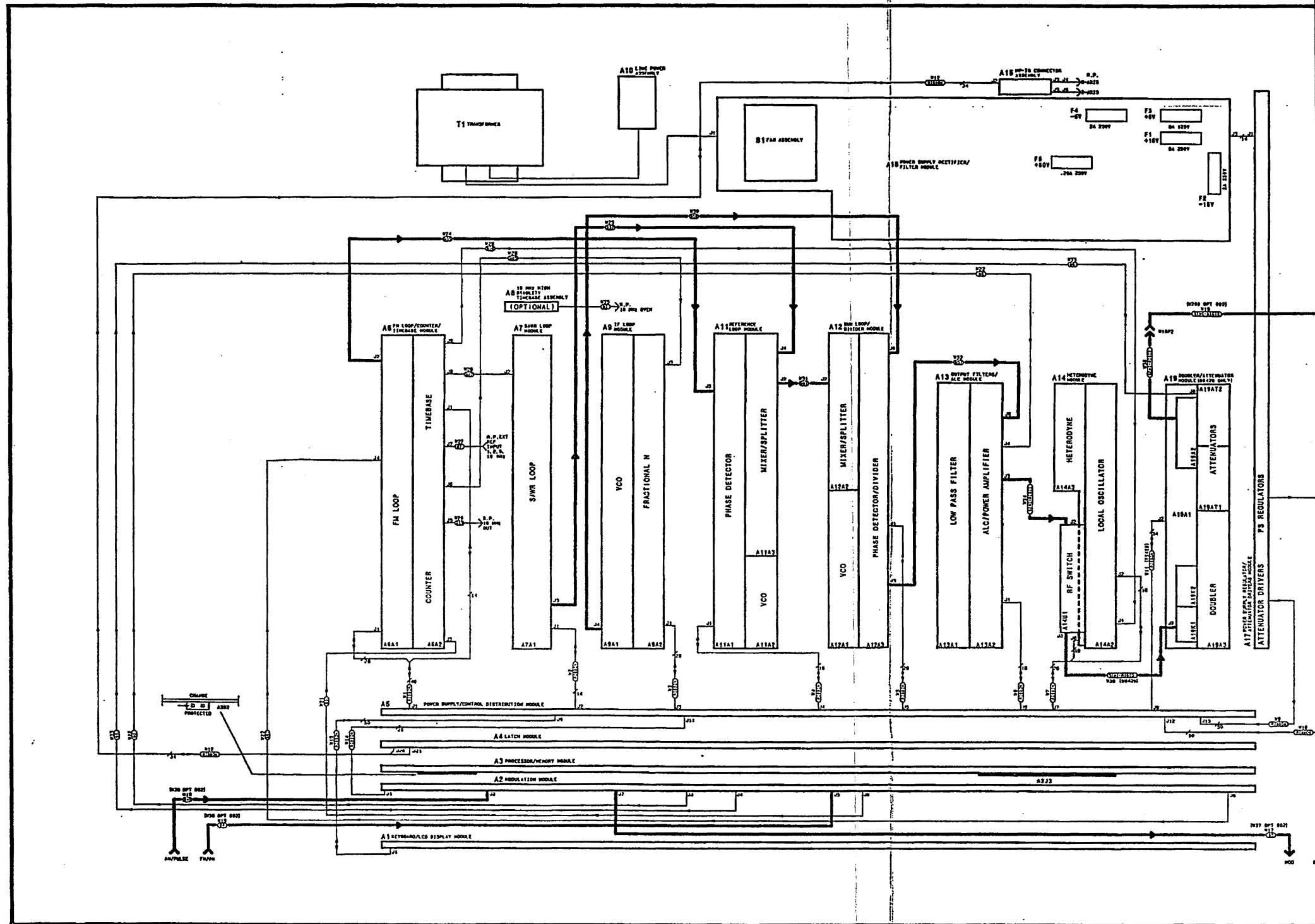

Figur

INSTRUMENT WIRING DIAGRAM

**CEMENT**

RM.04  
EXCHANGE DEFECTIVE MODULE  
GO TO REPLACABLE PARTS SEC

CONFIRMATION FAILED  
GO TO STEP 2

REPLACE MODULE  
GO TO ILD

DIF-FERENT MODULE  
GO TO ILD

GO TO REPLACABLE PARTS SEC

**TRANSFER TABLE**

Cal Data Select Keys	
No Data Required	9 HZ
	7 5 9
No Data Required	3 HZ
No Data Required	
001)	No Data Required
No Data Required	1 HZ
	2 HZ
	4 HZ
	8 HZ
	6 HZ
Module	No Data Required
	No Data Required
	5 HZ
	7 HZ

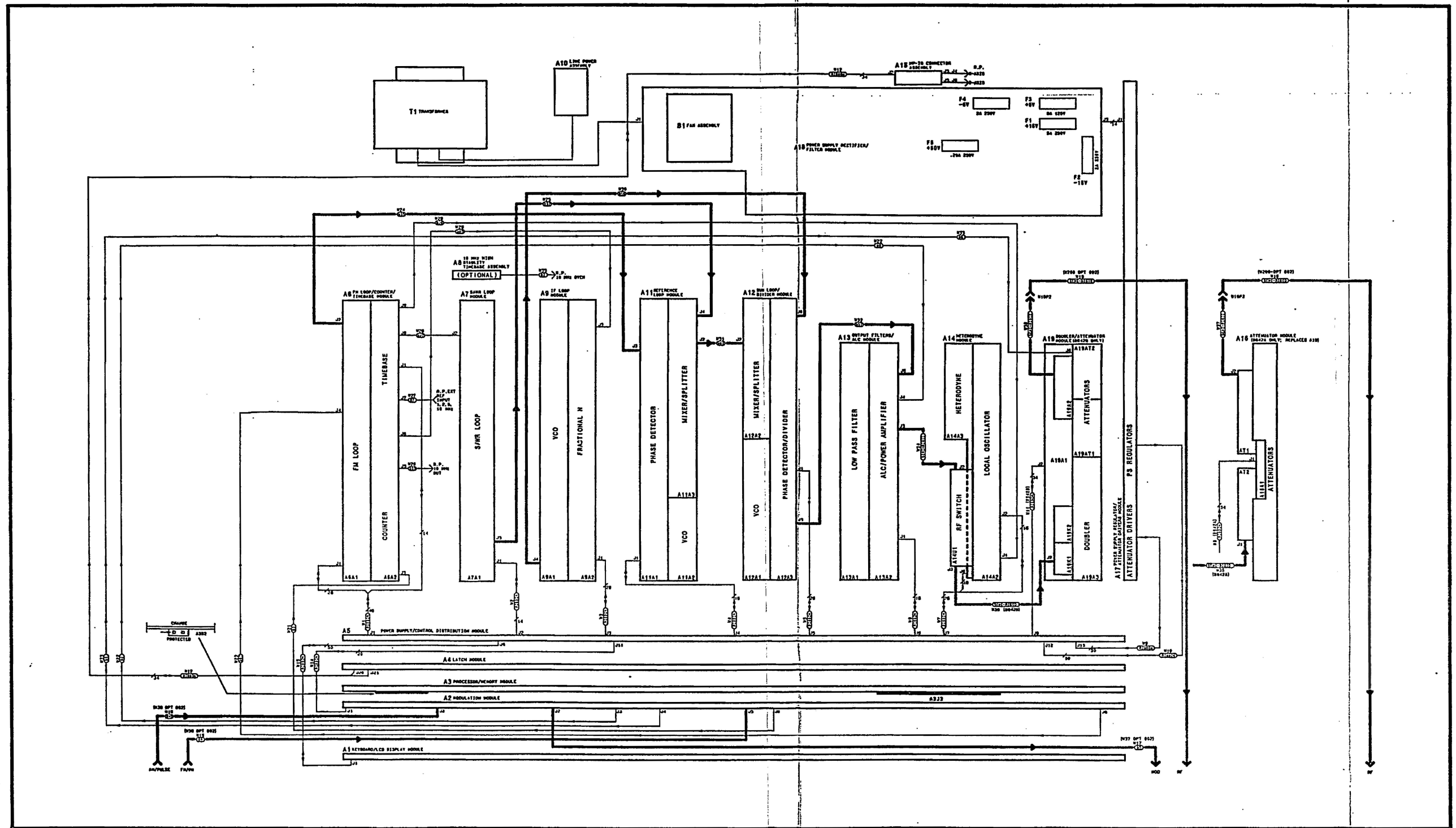

Figure 4-100. Replacing a Module.